

Owner's Manual

This Manual Must Be Read Before Operating The Equipment

SWEEPEx[®]

THE SWEEPING CHOICE



SWB-400

Serial No. R40-0913830001 and higher

TRYNEx[®]
INTERNATIONAL

Madison Heights, Michigan 48071
877-SWEEPEX
www.sweepexproducts.com

CUSTOMER COPY

Introduction	3
Safety	4-5
Operating Instructions.....	6-18
Component Vocabulary	6
General Safety	7
Operating in Winter	7
Operator Controls.....	8-9
Starting/Stopping Motor.....	10
Adjusting Handlebar Height.....	11
Transport	12
Adjusting Brush Pressure.....	13
Adjusting Discharge Direction	14
Debris Collector Box (Optional Accessory)	15
Leaf Collector (Optional Accessory)	16
Debris Shield (Optional Accessory).....	17
Plow Blade (Optional Accessory)	18
Maintenance Instructions.....	19-22
Tire Pressure	19
Oil and Gas	19
Adjusting Control Cables	20
Replacing/Changing Brushes	21
Maintenance Plan	22
Cleaning	22
Troubleshooting	23
Notes.....	24-27

Have a question or need assistance?

SweepEx Customer Care

877-SWEEPEX

or (248) 586-3500

Monday through Friday 8:00 AM to 4:30 PM EST

Fax: (248) 691-8378

E-mail: customercare@trynexusfactory.com

Website: www.sweepexproducts.com

This operating manual is intended to help you to get to know the SWB-400 and how to operate it safely, correctly and economically. If you observe these instructions, you will prevent hazards, reduce repair costs and breakdown times, and increase the reliability and service life of the machine.

This manual must be read and used in conformity to existing workplace regulations. The manual must be made available where the machine is being used.

The manual must be read and used by every person who will be working with or on the machine, such as for

- Operation (including preparation, repair during operation, & clean-up)
- Repairs (maintenance, inspection, overhaul), and/or
- Transport.

All established technical regulations for safety and proper working practice must be observed in addition to this manual and any applicable regulations for the prevention of accidents. Should you lose your Owner's Manual or would like extra copies, they can be purchased at your SweepEx dealer.



THIS SIGN SHOULD ALERT YOU:

This Safety Alert Symbol is used to pinpoint characteristics that, if not carefully followed, can create a safety hazard. When you see this symbol in this manual or on the machine itself, be alert! Your personal safety and the safety of others is involved.

Defined below are the Safety Alert Messages.



DANGER

DANGER

Information that, if not carefully followed, can cause death.



WARNING

WARNING

Information that, if not carefully followed, can cause serious personal injury or death.



CAUTION

CAUTION

Information that, if not carefully followed, can cause minor injury or damage to equipment.



IMPORTANT

This symbol is used to call out information that is important to follow carefully.

IMPORTANT EQUIPMENT INFORMATION

Record important machine information here for quick reference. This information can be found on the serial number plate located at the back of the machine on the wheel drive enclosure.

Model _____
Serial # _____
Engine Model _____
Engine Serial # _____
Date Purchased _____
Dealer where purchased _____

See separate Warranty Information Card for your warranty coverage.

Example

	TrynEx International LLC 531 Ajax Drive Madison Heights MI 48071 USA	
Engine: Honda GXV160 HP: 5.5 Weight: 205 lbs	Manuf. 2013	
Model: SWB-400	Serial No. R40-0913830001	

Note: Some of the photos in this manual show the SWB-400 with optional accessories or brush kits.

This page contains safety information to highlight safety hazards and precautions involved with operating your SWB-400. This page must be read and understood by all personnel who have any part with the assembly, use and care of this machine.

DANGER

Your SWB-400 is manufactured to state-of-the-art technical regulations. Despite this, it is possible that operation will result in danger to life and limb for the operator or third parties, impairments to the machine and other physical assets, if care is not exercised.

The machine is intended exclusively for use for brushing operations in property maintenance and snow clearance. Examples of intended use are: snow clearing; sidewalk, driveway & parking lot cleaning (with multi-purpose brushes); spring debris clean-up; dethatching; clearing debris from artificial turf; and leaf clean-up (with Multi-Purpose brushes). Any operation over and above these uses will be considered as a non-intended use. SweepEx will not be held liable for any resulting damages. The operator alone is responsible for any risk. Intended Use also includes observance of the Owner's Manual and keeping to all service and maintenance procedures.

Always keep the Owner's Manual available at the machine's place of work. In addition to this Owner's Manual, furnish all users with information regarding legal or other important regulations regarding accident prevention. These duties can include handling hazardous materials; wearing personal safety equipment; and traffic regulations. You should supplement this Owner's Manual with instructions covering information related to use of powered machinery; and operating equipment near people, other machines and traffic.

Do not smoke or have any open flame near the machine. Gasoline vapors could explode.

Only use the machine in perfect condition and according to applicable regulations. Be aware of your surroundings and alert to what you are doing to reduce hazards. You should always repair faults which could influence the safety of the machine.

WARNING

Personnel operating the machine must read the Owner's Manual before using – especially all safety information. This includes people who occasionally work on or operate the machine such as for service and transport. A clear understanding of how to operate the machine will reduce dangers involved with operating powered equipment.

You must check that personnel operating the machine are paying attention to safety and hazards and under observance of this Owner's Manual. Operating personnel may not have long hair, or wear loose clothing or jewelry, including rings – these items can catch and be pulled in by moving parts.

Keep all safety and hazard information for the machine complete and in readable condition. If the machine is altered with regard to its safety or changes its operational behavior, stop operation immediately and report the malfunction to the responsible department or person.

The SWB-400 may only be operated with brushes approved by SweepEx.

Do not carry out any alteration, addition or rebuilding to the machine which could influence its safe operation. This especially applies to addition and alteration to safety devices and machine controls, and to welding work on load-bearing components.

Personal protection equipment must be worn to prevent accidental injury. Observe all safety and hazard information for the machine.

Rotating brushes cause flying debris, wear safety glasses with side protection.

Wear high-visibility clothing, especially when working around other machines, people and vehicles.

Be aware of and avoid pinch points when assembling and operating. Pinch points can exist around levers and when putting two parts together (during assembly).

Use barriers and traffic cones when working in areas of pedestrian and vehicle traffic to keep everything at a safe distance.

CAUTION

Use genuine SweepEx parts for replacement. These meet the specific technical requirements. Observe all deadlines indicated in the Owner's Manual for maintenance checks and service

Suitable and adequate mechanic's equipment is required for performing maintenance and service procedures.

The SWB-400 is powered by gasoline. Know the location of fire extinguishers and observe fire safety procedures.

PERSONNEL

Work on or with the machine may only be carried out by reliable personnel. Observe statutory minimum legal ages. Only operate the machine with trained personnel.

Clearly define personnel responsibility for operation, service and maintenance. Ensure the machine is operated only by authorized personnel

Determine machine operator responsibilities – including road traffic regulations.

Persons in training may only operate the machine under the supervision of an experienced operator.

Work on any part of this machine must be carried out by an experienced mechanic.

Work on drive mechanisms, brakes and steering equipment may only be carried out by suitably trained persons.

DANGER ZONE

Keep all bystanders away from the machine at least 30 feet (10 meters); out of the danger zone as described in the diagram below.

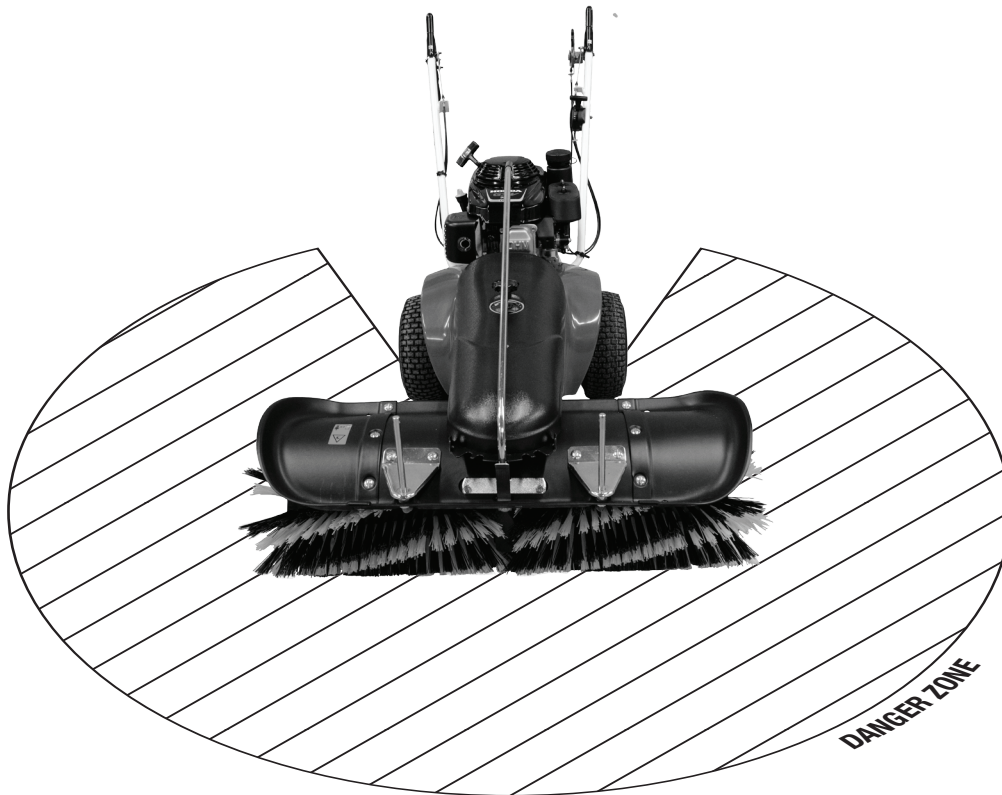

DANGER

Flying objects; Keep safe distance from the machine when engine is running.

Component Vocabulary

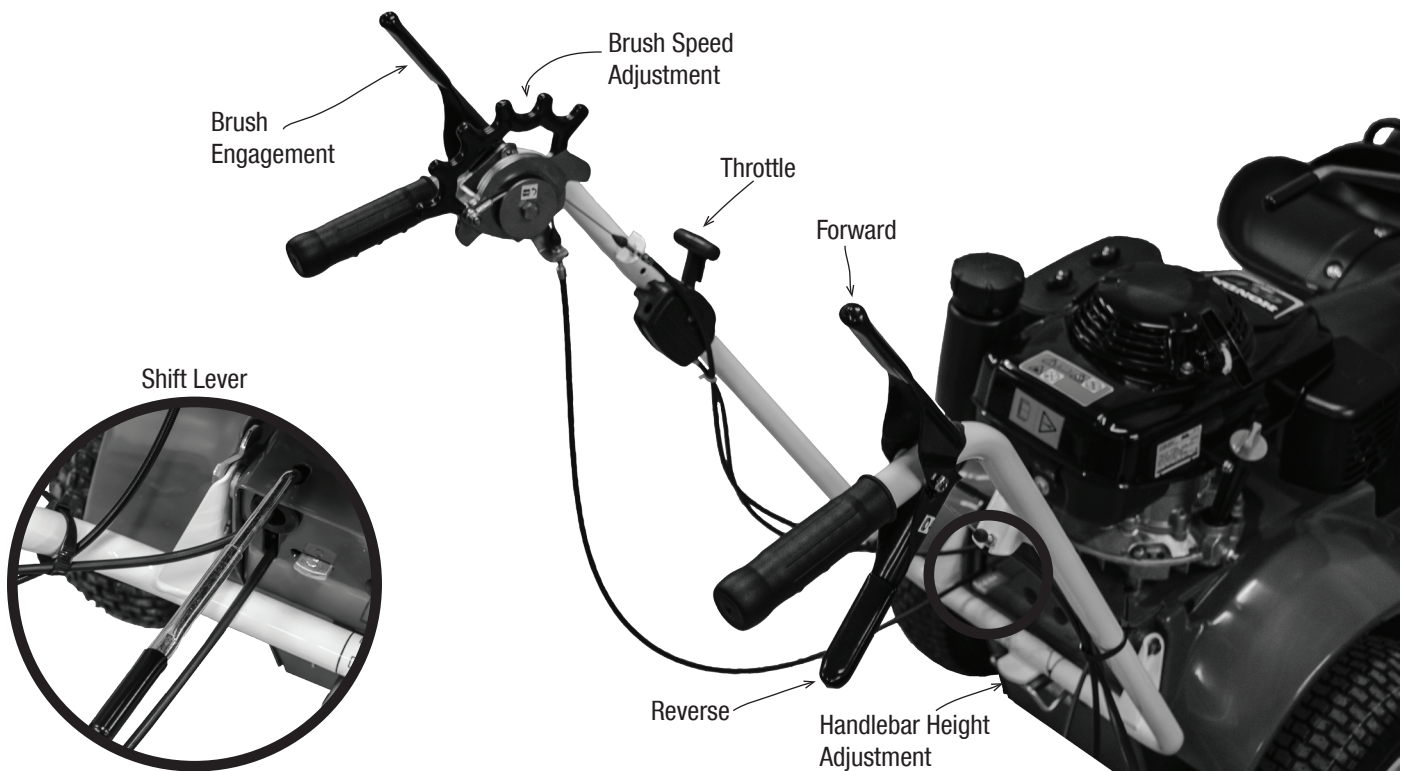
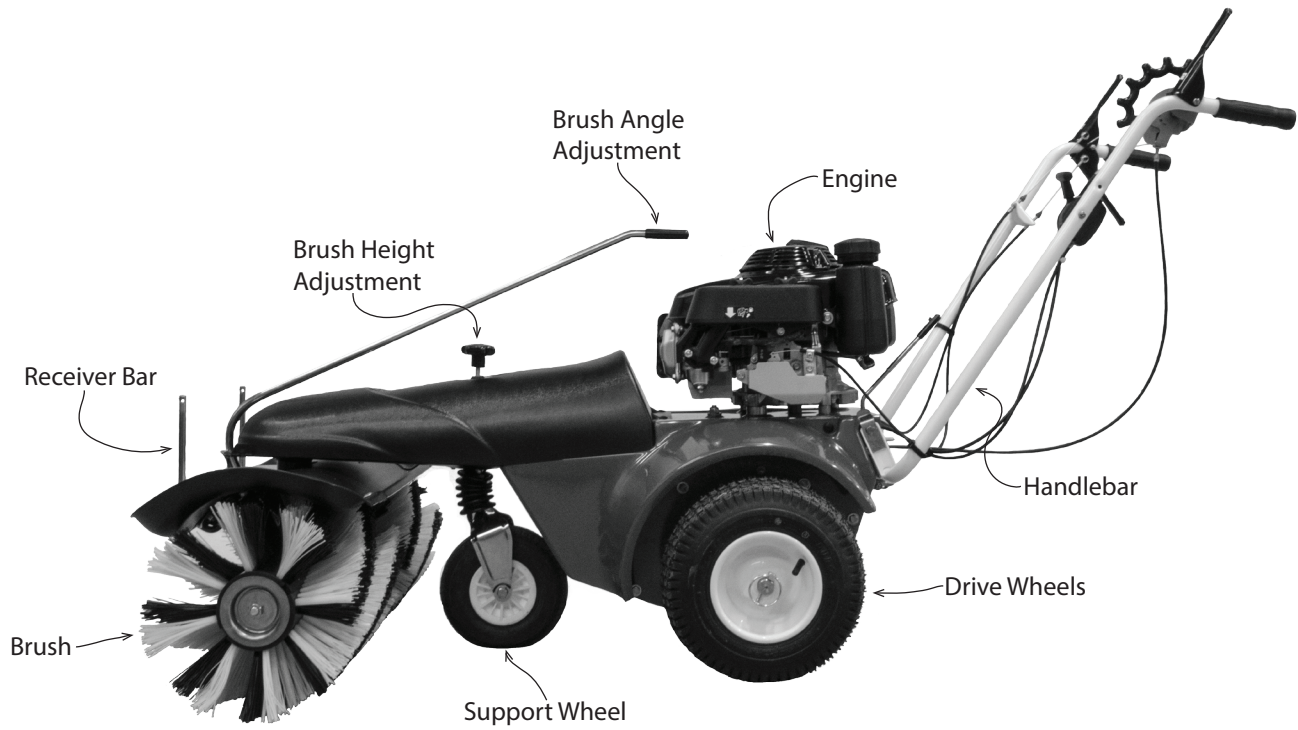

General Safety / Operating in Winter

GENERAL SAFETY



Do not operate the machine in an unsafe manner! Make yourself familiar with the surroundings before starting work in a new location. The working surroundings include any obstacles in the work area or on roads, the ground load-bearing capacity and any necessary workplace safety precautions in live traffic.

Take precautions to ensure that the machine is only operated in a safe and functional condition! Only operate the machine if all protective and safety devices are present and working!

Check the machine for externally visible damage and faults before operation! If malfunctions occur stop the machine and secure it immediately! Repair malfunctions immediately! Only start the machine from the operator's position! Ensure that no one can be endangered by starting the machine before switching it on or operating it!

Check that braking, steering, and brushing are fully functional before operation!

Before operating the machine, always check that accessories are fitted correctly! Always observe applicable traffic regulations before operating on public roads, paths or parks, and ensure that the machine is in a condition suitable for use in traffic

Always ensure that suitable lighting is available before working in poor light or darkness! Always keep a sufficient distance between the machine and drop-offs, holes or slopes!

Do not permit any method of working which will affect the stability of the machine!

Never traverse across slopes; always travel up and down, not across.

Adjust the speed to suit the conditions on inclines! Change gear before the incline, not on it! Always secure the machine against rolling away and unauthorized operation before leaving it unattended!

OPERATING IN WINTER



Check regularly that the air filter is dry. If the air filter has become wet, let it dry overnight. There is a possibility of the engine not starting due to a clogged air filter.

Spray the throttle cable with silicone spray at both ends, and the throttle linkage before operating to prevent the cable or throttle mechanism from freezing up.

Before putting the machine away, sweep it clear of snow.

Avoid freezing the machine. Store the machine in a frost-free room.

Silicone Spray attracts dust and binds it to the machine. It is only a suitable lubricant in wintry and snowy conditions.

Do not spray Silicone Spray on hot engine. It could cause a fire. Follow the instructions on the spray can.

Remove Foam Pre-Filter.

Use SAE 5W-30 Motor Oil.

Operator Controls



DANGER

With long sleeves, the handlebar can get stuck inside the sleeve; This could prevent the drive from disengaging and result in injury. Set the bar lower if wearing long sleeves or tightly button the sleeves.



WARNING

Avoid injury and damage; Make completely sure that there are no persons or objects within the danger zone.



CAUTION

If the brushes are switched on and the SWB-400 is not in gear the machine can roll backwards. The handlebar must be securely engaged at the required height.

HANDLEBAR CONTROLS

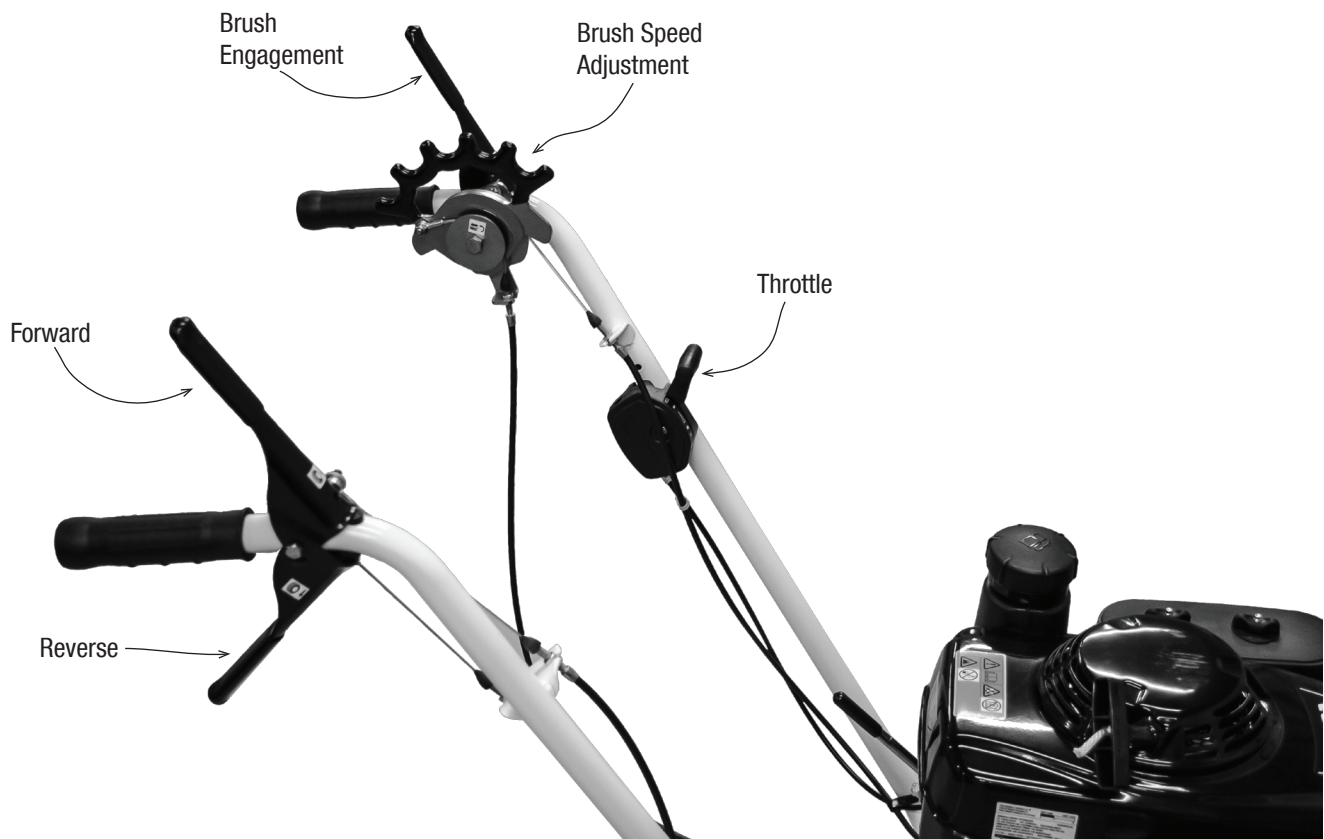

DRIVING AND SWEEPING

Sweeping and Driving can be engaged independent of each other. Having the brush engaged without the transmission engaged will cause the machine to roll backward. The brush can be engaged and disengaged as necessary while driving.

The brush speed can be adjusted to your preference (see “Adjusting Brush Speed”). If the brush starts to leave debris behind, increase the rotation speed (see ‘Adjusting Brush Speed’) and select a lower gear (see ‘Gear Selection’).

The SWB-400 is also equipped with a reverse gear. Come to a complete stop before engaging the reverse gear. Ensure the area behind is clear before backing up. Do not operate brush in reverse.

Operator Controls

SELECTING A GEAR

☞ Come to a complete stop before changing gears.

The SWB-400 is equipped with a three-speed transmission. First Gear is the slowest setting and engaged by pushing the shift lever all the way forward. Third Gear is the fastest setting and is engaged by pulling the lever all the way back. Second Gear is in the middle. You will feel the lever lock into a detent and hear a “click.” The active gear is the smallest visible number on the ‘indicator’ below and to the right of the shift lever.

See “Component Vocabulary” for location of ‘Shift Lever.’

FREEWHEEL

There is a freewheel mechanism on each wheel. The freewheel makes turning the machine easier. One or both wheels can be locked for working on inclines and when clearing snow.

The freewheel is disabled by putting the linchpin through both wheel and axle, locking the two together.

When using the plow or using the leaf collector, locking the wheel on the windrow-side will reduce the lateral force on the handlebars.



Freewheel.



Locked.

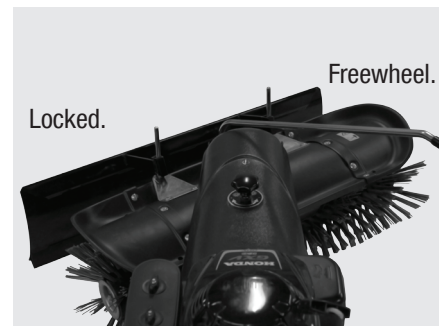

Plowing.

ADJUSTING BRUSH SPEED

The speed of the brushes can be increased using the lever on the left handlebar. The brush speed must only be adjusted when the brush is switched on.

When sweeping dust, use a low brush speed.

When sweeping leaves or similar material, use a high brush speed.

When sweeping snow, use a high brush speed.

When using the Debris Collector Box, use a medium brush speed.

Remember that an increased brush speed will throw debris farther, therefore increasing the danger zone.

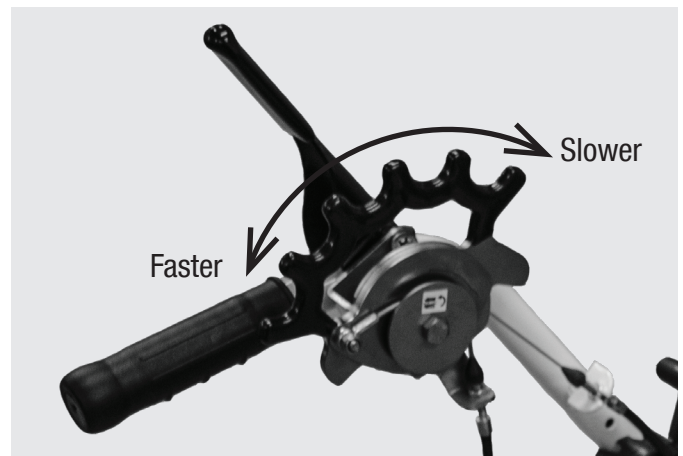

Starting/Stopping Motor



Never run the motor in an enclosed or confined space. The exhaust fumes contain poisonous gases. Ensure that the transmission and brush are switched off before starting. The handlebar must be secure at the required height.



Before starting the motor, ensure there is sufficient oil. The motor is not filled with oil when the machine is delivered.

STARTING



Move throttle to choke.

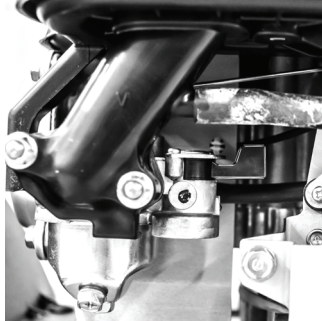

Make sure fuel valve is on.

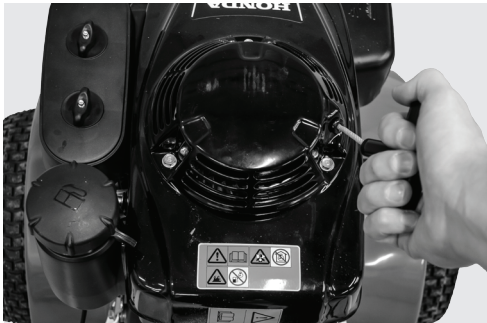

Pull starter coil. Stand behind the handlebars. Do not press any levers.

STOPPING

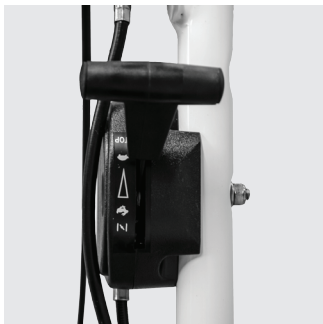

Turn Throttle to off.

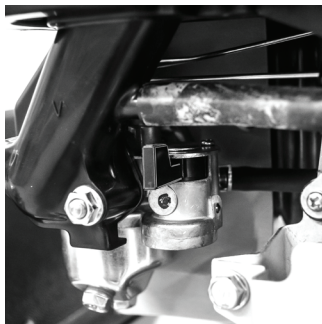

Close Fuel Valve.

Operating Instructions

Adjusting Handlebar Height

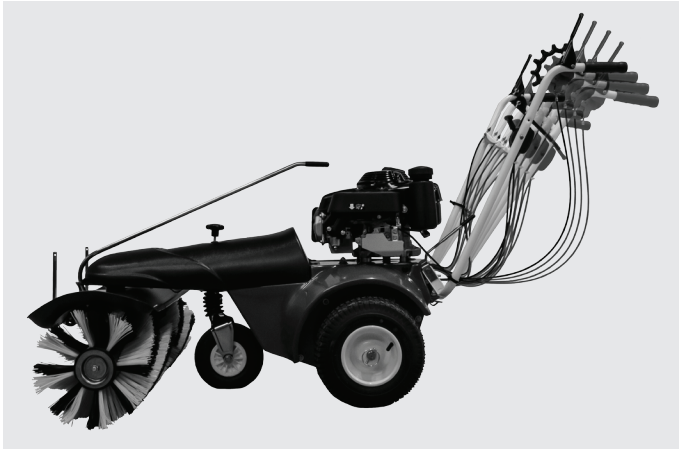

There are four possible settings for handlebar height.



Push the 'lever lock' down (centered at the base of the handlebars).

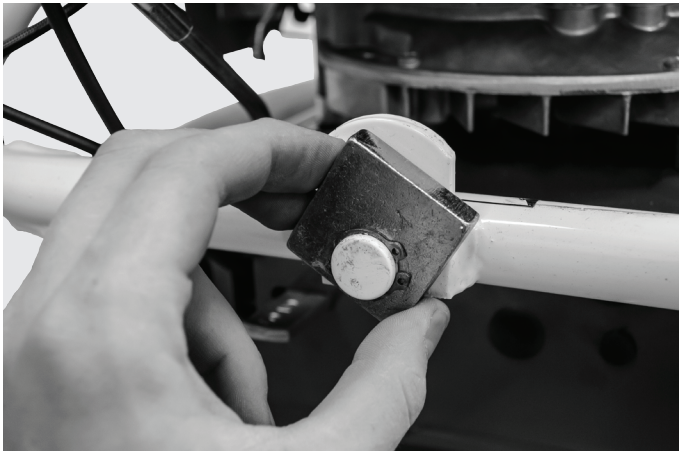

Tilt the handlebars slightly forward; Turn the 'adjusting block' to the desired setting.



Tilt the handlebars back into position; push the 'lever lock' back in place to lock.



You can fold the handlebars fully forward to save space when storing or transporting.

Transport

CARRYING

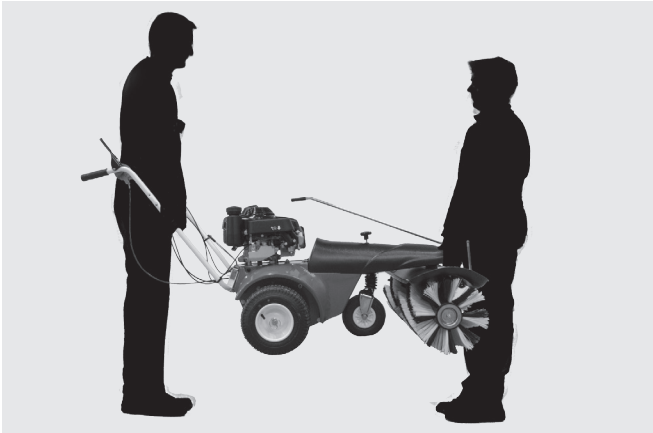

Two people are required to lift and carry the SWB-400.



Position of hands to carry the front of the machine.

SECURING DURING TRANSPORT

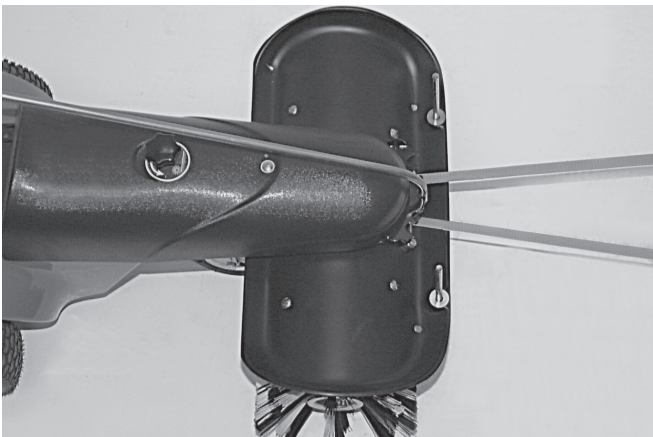

Use a ratchet strap at the front around the brush input shaft (located between the brush drive shroud and the brush shield).

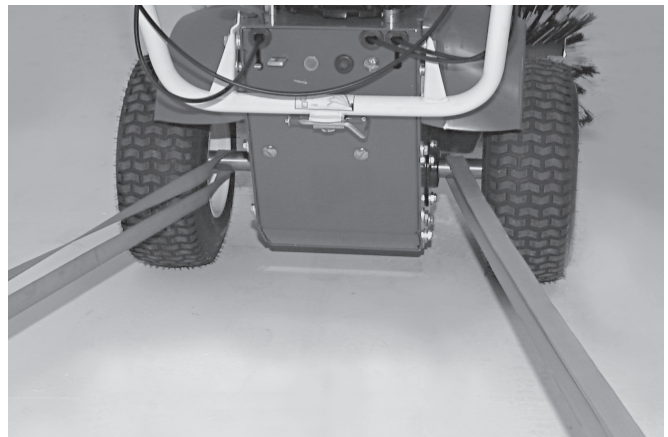

Use two straps at the rear; one on each side of the axle.



Fold the handlebars fully forward when transporting.

Adjusting Brush Pressure

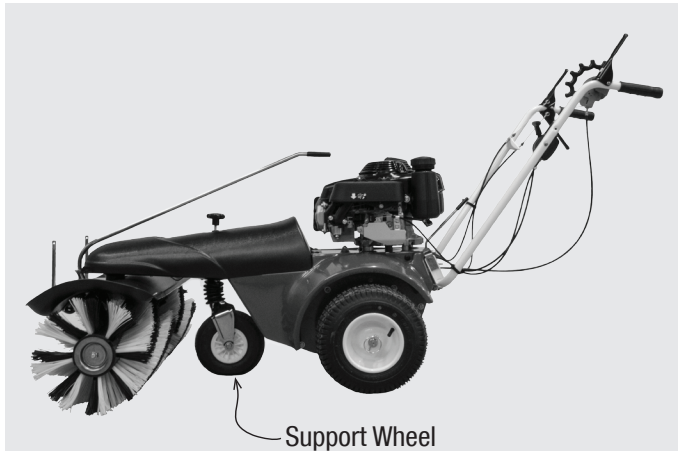

The brush height can be adjusted in fine increments by adjusting the height of the support wheel.



The adjustment knob is located above the support wheel.



Lower the brush by turning the knob in the direction of the 'minus' arrow until it just touches the floor. Turn the knob three more turns and the brush height is just right for sweeping.



Turn clockwise (+): raise brush
Turn counter-clockwise (-): lower brush



IMPORTANT

If the brushes are heavily worn, or if you are brushing cobblestones or brick pavers, lower the brush one more turn.

Please note: if the brush pressure is too heavy, the cleaning effect is decreased because the brush fibers are bent too much.

If you do not intend to use the SWB-400 for a long period of time, release the pressure on the brush by raising the brush.

Operating Instructions



Adjusting Discharge Direction



There are five different settings available for the discharge direction.

Here: Forward Discharge Direction. The swept material will heap up in front of the brushes. You should give preference to angled brush settings.



To adjust brush angle: Lift the lever; Turn the brush in the desired direction; Release the lever and ensure the lever is latched in place.

Here: Material will be discharged to the right.



With an angled setting, the material will be swept to one side.

Here: Material will be discharged to the left.

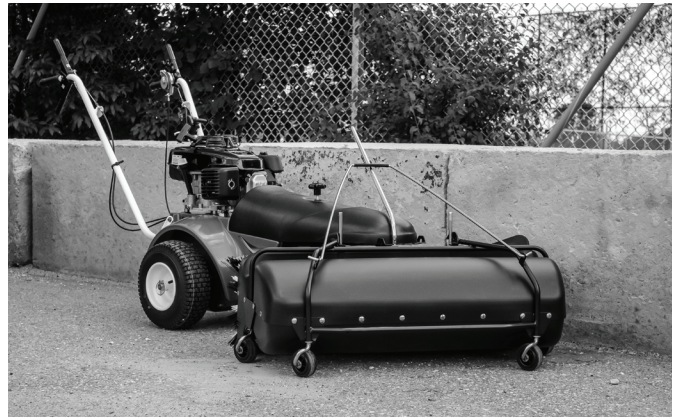

A sideways setting is recommended if using the optional Debris Collector Box. This will allow sweeping against a wall or curb.

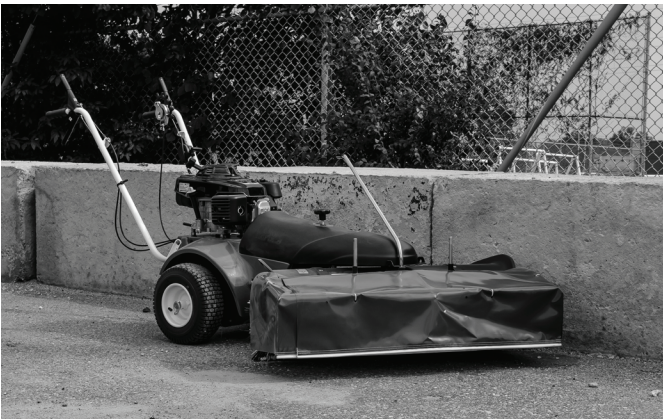

A sideways setting is recommended if using the optional Debris Sheild. This will allow sweeping against a wall or curb.



A sideways setting is required when using the optional Leaf Collector or optional Snow Plow.

Here material will be discharged to the left.

Operating Instructions

Debris Collector Box (Optional Accessory)



SWB-400 with Debris Collector Box (DCB-400).
Mount as shown below, paying attention to the alignment with brush hood.

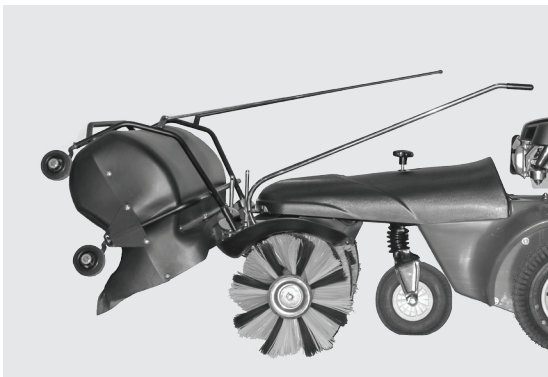
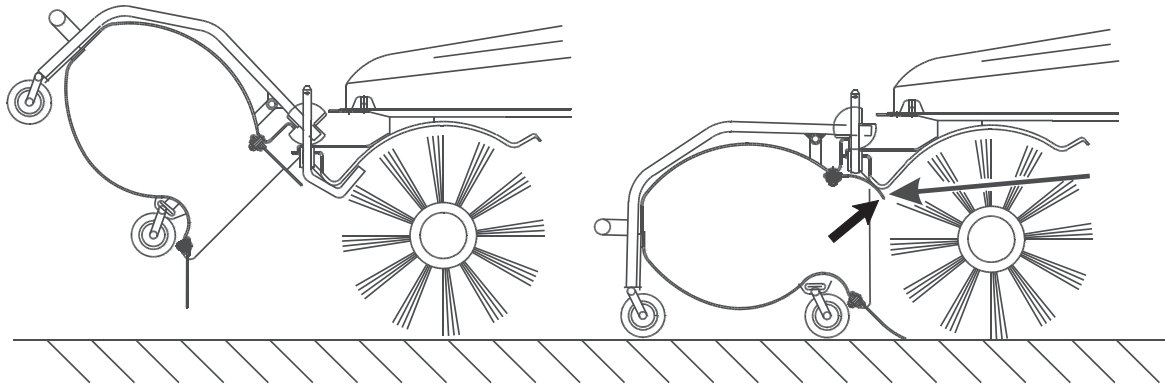

To dump the debris, simply pull the handle from the operating position so the debris can fall out.

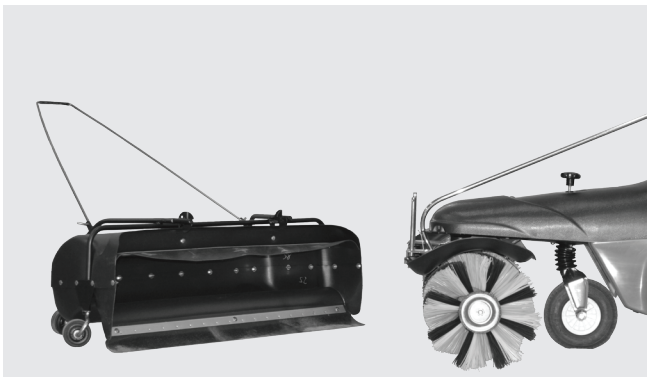

To dump the debris into a separate container, remove the Collector Box from the sweeper and use the handle to tow it to your other container.

Operating Instructions



Leaf Collector (Optional Accessory)

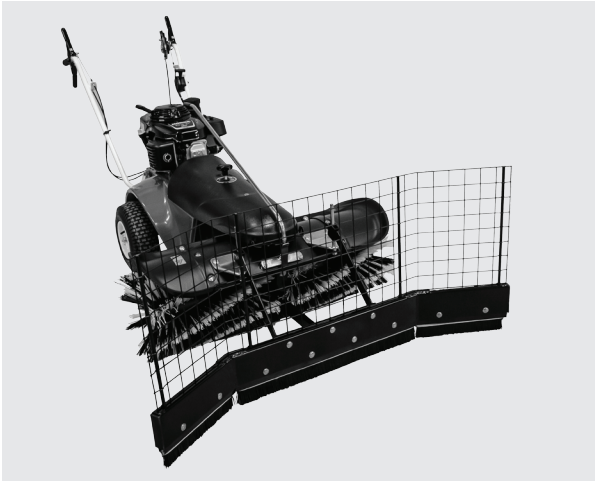

SWB-400 with optional Leaf Collector (LCA-400).

ATTACHING LEAF COLLECTOR TO SWEEPER...



Attach the broom of the leaf collector to the Sweeper. The tubes of the upper support slide over the receiver bar on the sweeper. The lower support will rest against the center brush drive.

CONTINUED...



Attach the screen by inserting the upright supports of the screen into the holes in the top of the broom.

STORAGE

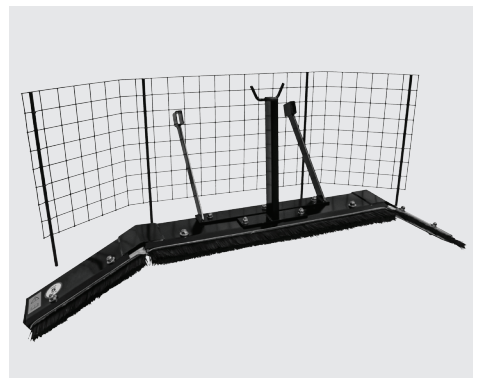

Store indoors as shown.

Operating Instructions

Debris Shield (Optional Accessory)



SWB-400 with optional Debris Shield (PCA-400).

ATTACHING DEBRIS SHIELD TO SWEEPER...



Slide the Debris Shield over the receiver bars.

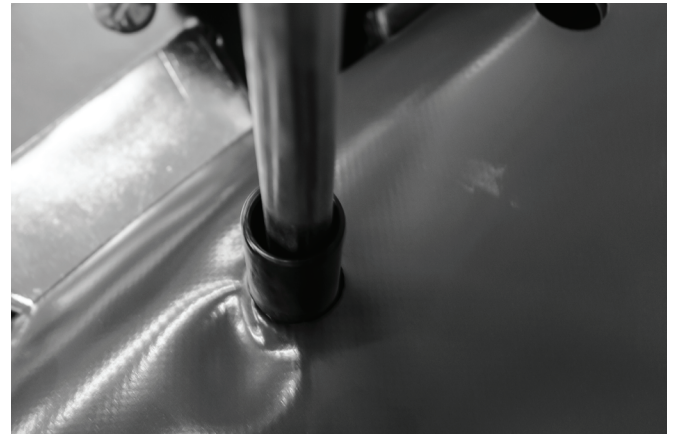

Close-Up of receiver bar with Debris Shield.

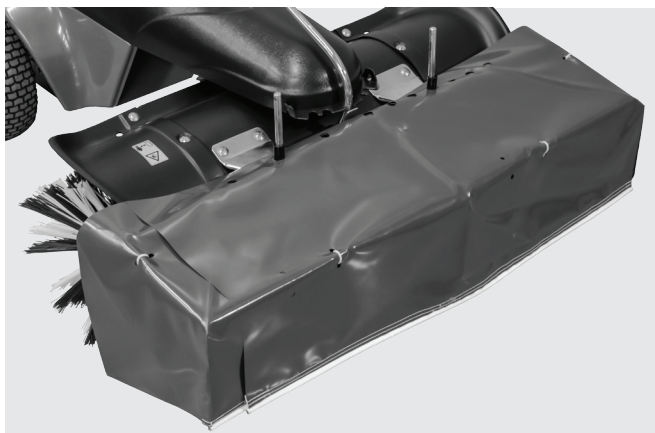

Finished.

Operating Instructions



Plow Blade (Optional Accessory)



SWB-400 with optional Snow Plow (SSB-400)

The Snow Brush Kit (SRS-400) is recommended when clearing snow.

ATTACHING SNOW PLOW TO SWEEPER...

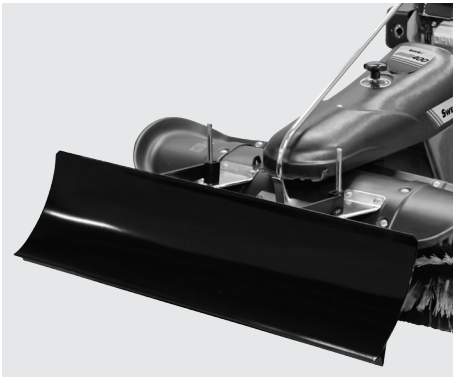

To install the Plow Blade: lift the Plow and hold it at an angle; slide it over the Receiver Bars and lower it into position.



Plow hanging on Receiver Bar.



Lower Support.

OPERATING

An angled setting must be used when plowing snow.

The plow is not necessary when clearing small amounts of snow – 1 inch or less (2.5 cm).

For snow over 1 inch (2.5 cm), use the plow blade.

The SWB-400 with the SSB-400 Plow can clear a maximum of 5-1/2 inches (14 cm) snow in one pass. *If snow is heavy the capacity will be less.*

See “Freewheel” to adjust freewheel correctly for plowing snow.

Tire Pressure / Oil and Gas



IMPORTANT

If the tire pressure is too low, the inner-tube will rub against the wheel and be damaged.
Over-Inflation can cause the tire to burst.
Check the tire pressure for both the support and drive wheels regularly.

Unscrew the valve cap and use a tire inflation device to check or inflate the tire as necessary. Always replace the valve cap when you have finished inflating.



SUPPORT WHEEL

30 psi (2 bar).
On Rough Surfaces:
22 psi (1.5 bar)

DRIVE WHEELS

22 psi (1.5 bar).

OIL AND GAS

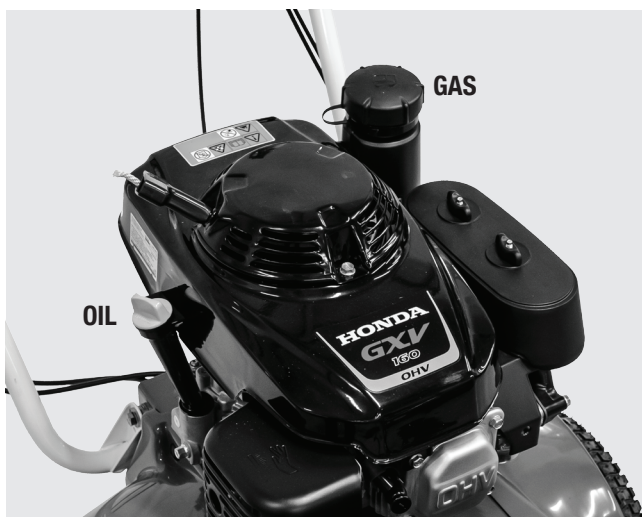

Capacities:

Oil 0.58 qt. (0.55 L)
Gasoline 0.95 qt (0.9 L)

Use 86 octane or higher unleaded gasoline.

1. Remove oil cap; wipe dipstick clean.
2. Replace dipstick in the oil filler neck; do not screw down.
3. Remove dipstick; check oil level. The oil should be up to the upper marking.
4. If oil level is low, fill up to the upper marking on the dipstick with the recommended oil (see Honda Owner's Manual).
5. See marking on the dipstick for fill level.

Adjusting Control Cables



IMPORTANT

It may be necessary to reset the cables when assembling the machine; and after the first few hours of operation. Free movement of the lever should be about 1/3 of the lever's total movement. For the remaining 2/3 there should be a definite resistance.



Loosen the top nut with a 10 mm wrench (about one turn).



Tighten by turning the lower nut.

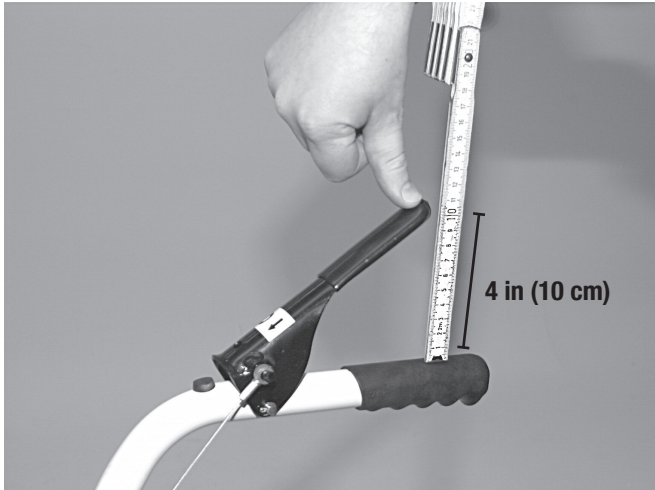

Check the adjustment. Press the lever down; measure the distance between the lever and the handlebar when you begin to feel resistance. The distance should be 4 inches (10 cm).

Maintenance Instructions

Replacing / Changing Brushes



IMPORTANT

Check the brushes after every 20 hours use. The brushes must be replaced if you are no longer satisfied with the brushing result, or if the brush diameter is below 8-5/8 inches (220 mm).

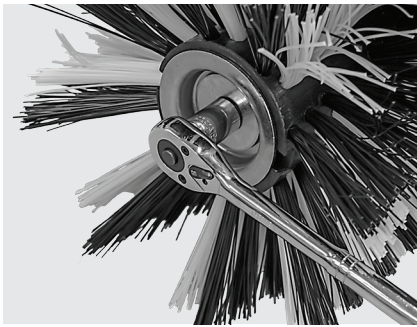

1. Loosen the nut on the axle. Use two 19 mm wrenches.



2. Remove the left brush.



3. Remove the axle with the right brush.

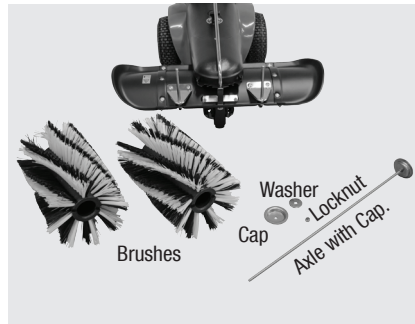

4. Parts after disassembly.

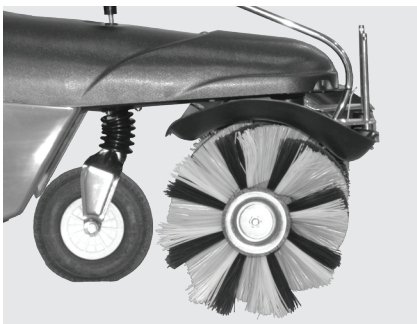

5. If replacing the Multi-Purpose Brushes, or changing to them: The black row of bristles must touch the ground before the white row when the brush rotates.

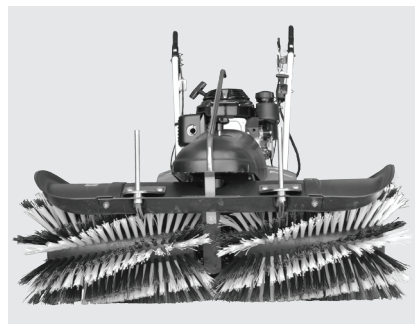

6. For any other bristle kit, the bristle rows should be curving upward from the left (looking at the front).

Note: Multi-Purpose Bristle shown for clarity.

Refer to the Assembly Instructions for installing the new brushes.

Maintenance Plan / Cleaning

	before every use	after the following operating hours					after 3 month min.	at least annually	after every cleaning
		5	10	25	50	100			
Check screws and nuts			C						
Check motor oil level, refill if necessary	C								
First motor oil change		S							
All further motor oil changes					S		S		
Check air filter	C								
Clean air filter element, earlier if necessary				M		M			
Replace air filter element, earlier if necessary					M				
Replace fuel hoses							S (2 Years)		
Clean cool air screen	M								
Clean baffle plate, cooling ribs, earlier if necessary						S			
Clean spark plugs, adjust gap					S				
Replace spark plugs						S			
Clean exhaust		M							
Lubricate all moving parts							M	M	
Check hand lever play setting	C								
Check brush wear, earlier if necessary				C					
Stretch chain drive			C	S					

KEY	
S	Maintenance by Specialist
C	Check by Operator
M	Maintenance by Operator



IMPORTANT

If you are not intending to use the machine for a long time, it should be properly stored. Please contact your local dealer for suitable storage practices in your geographic location.

CLEANING

To keep your SWB-400 in good condition, you should clean it regularly.

Remove loose dirt or dust with a car wash brush. Wash plastic surfaces with water and soap. Use normal car cleaning soap. Rinse off all cleaners thoroughly with clean water.

To give plastic parts a gloss finish, use a plastics care product.

Observe the instructions on the cleaning solution package.

You can use glycerine as a corrosion protection for heavily soiled parts.

Do not use pressure washers, the high pressure may force water into bearings, seals and the motor, causing damage.

FAULT	POSSIBLE CAUSE	FAULT REMEDY
Motor will not start	Fuel tank empty	Fill fuel tank
	Throttle lever not set to choke when motor is cold	Set throttle lever to choke
	Spark plug leads not connected	Connect spark plug leads
	Fuel line blocked	Send fuel line to dealer for cleaning
	Motor receiving wrong air due to loose carburetor	Tighten fixing screws
	Fuel valve closed on Honda motor	Open fuel valve on Honda motor
Motor will not start, gasoline smell	Motor is receiving too much fuel	Set throttle lever to full speed, not to choke
	Air filter dirty	Clean air filter
Motor running badly, misfires	Motor running with choke activated	Move throttle lever out of choke position
	Spark plug leads loose	Allow motor to cool and connect spark plug leads firmly
	Air filter soiled	Clean air filter
	Air bleed hole in fuel tank filler cap blocked	Replace fuel tank filler cap
	Fuel line blocked	Clean fuel lines
		Replace fuel lines
		Run fuel system cleaner through tank of gas
	Carburetor not correctly adjusted	Adjust Carburetor/Send to dealer
Motor overheating	See fault "Motor Overheating"	
Motor misfires at high speed	Spark plug gap not correct	Adjust spark plug gap/Send to dealer
	Carburetor not correctly adjusted	Adjust Carburetor/Send to dealer
Motor overheating	Oil level too low	Refill motor oil
	Air cooling system restricted	Send to dealer/adjust air cooler grille and cooling ribs
	Air filter dirty	Clean air filter
	Carburetor not correctly adjusted	Adjust Carburetor/Send to dealer
Motor often stops during turnover	Throttle lever not set to choke when motor is cold	Set throttle lever to choke
	Spark plug gap not correct	Send carburetor to dealer for adjustment
	Air filter dirty	Clean air filter
Motor has lost power	Air filter soiled	Clean air filter
	Compression too low	Send to dealer for adjustment
Motor will not stop	Motor stop lever not correctly adjusted	See Honda Owner's Manual/Send to Dealer
Perpetual squeaking when brushes switched on	Switch lever not completely pressed down	Press switch lever completely down
	Control cable not correctly adjusted	Re-adjust brush control cable
Brushes do not turn, or stop moving under load	Switch lever not completely pressed down	Press switch lever completely down
	Control cable not correctly adjusted	Re-adjust brush control cable
	Toothed belts defective	Send to dealer
Machine will not move forward	Movement control cable not correctly adjusted	Re-adjust control cable
	Tension on toothed belt between motor and gearbox too low	Send to dealer
Machine leaves unbrushed central strip	Discharge direction forward with worn brushes	Turn the discharge direction to the side
	Brushes worn	Replace brushes
Bad brushing results	Brushes wrongly mounted	Mount brushes correctly, observe working direction
	Brush pressure too high	Readjust support wheel, reduce brush pressure
	Brushes not genuine SweepEx parts	Use only SweepEx brushes
	Brushes not suitable for application	Contact Customer Care to determine correct brush kit
Bad brushing results with Debris Collector Box	Debris Collector box not fitted correctly, sealing lip above brush cover	Mount swept material container correctly.

Notes



