

MP Series

Triplex Ceramic Plunger Pump Operating Instructions/ Repair and Service Manual

Pump Models:

MP4120

MP4124

MP4135

MP4130

MP4130HK

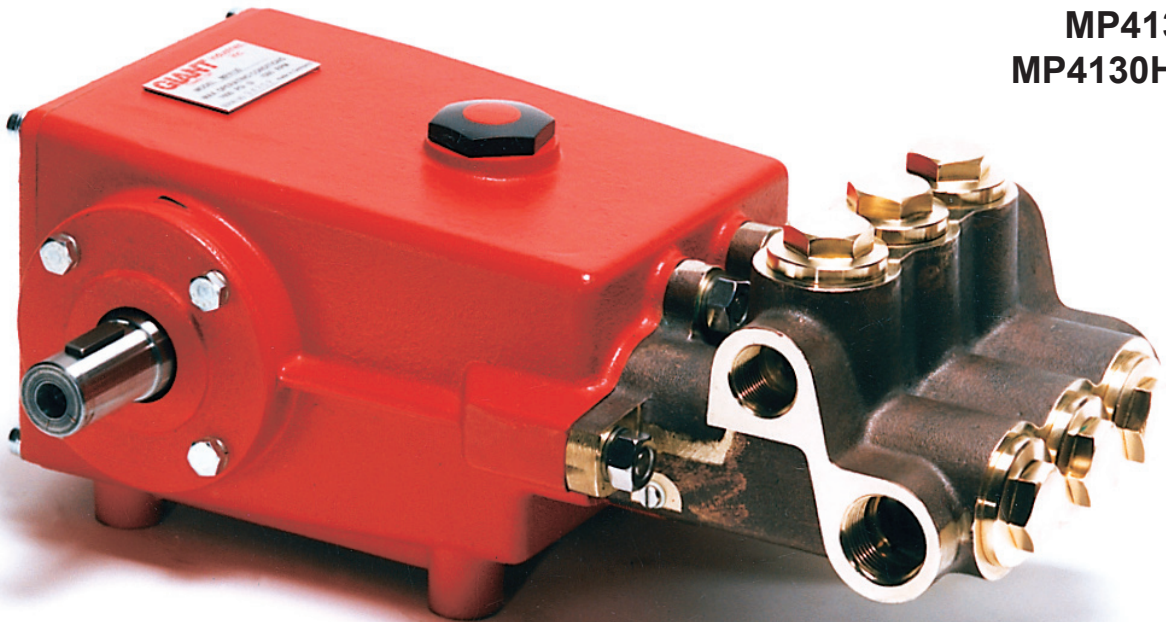

The logo for GIANT, featuring the word "GIANT" in a bold, black, sans-serif font. The letters are stylized with a 3D effect, appearing to be made of stacked blocks or have a layered appearance.

Updated 6/12

Contents:

Installation Instructions:	page 2
Pump Specifications:	page 3
Exploded View:	page 4
Parts List / Repair Kits:	page 5
Trouble Shooting:	page 6
Repair Instructions:	page 7-11
Torque Specifications:	page 11
Dimensions:	page 11
Warranty Information:	back page

INSTALLATION INSTRUCTIONS

Installation of the Giant Industries, Inc., pump is not a complicated procedure, but there are some basic steps common to all pumps. The following information is to be considered as a general outline for installation. If you have unique requirements, please contact Giant Industries, Inc. or your local distributor for assistance.

1. The pump should be installed flat on a base to a maximum of a 15 degree angle of inclination to ensure optimum lubrication.
2. The inlet to the pump should be sized for the flow rate of the pump with no unnecessary restrictions that can cause cavitation. Teflon tape should be used to seal all joints. If pumps are to be operated at temperatures in excess of 160° F, it is important to insure a positive head to the pump to prevent cavitation. See chart below.

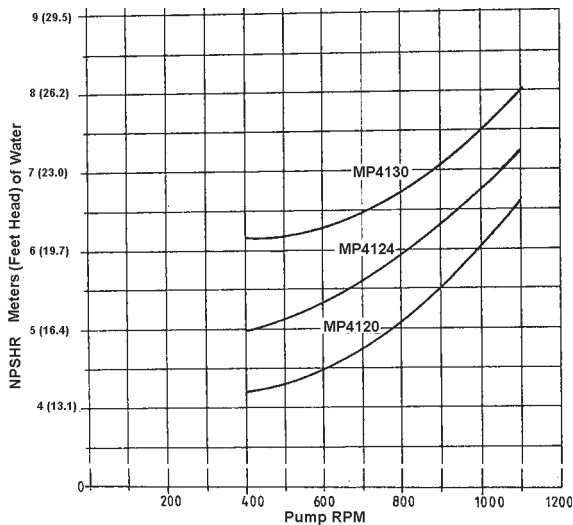

Finally, remember that high pressure operation in a pump system has many advantages. But, if it is used carelessly and without regard to its potential hazard, it can cause serious injury.

IMPORTANT OPERATING CONDITIONS

Failure to comply with any of these conditions invalidates the warranty.

1. Prior to initial operation, add oil to the crankcase so that oil level is between the two lines on the oil dipstick. **DO NOT OVERFILL.**

**Use SAE 85W - 140 Industrial Gear Oil
Giant's p/n 01154**

Crankcase oil should be changed after the first 50 hours of operation, then at regular intervals of 500 hours or less depending on operating conditions.

3. The discharge plumbing from the pump should be properly sized to the flow rate to prevent line pressure loss to the work area. It is essential to provide a safety bypass valve between the pump and the work area to protect the pump from pressure spikes in the event of a blockage or the use of a shut-off gun.

4. Use of a dampener is necessary to minimize pulsation at drive elements, plumbing connections, and other system areas. The use of a dampener with Giant Industries, Inc. pumps is optional, although recommended by Giant Industries, Inc. to further reduce system pulsation. Dampeners can also reduce the severity of pressure spikes that occur in systems using a shut-off gun. A dampener must be positioned downstream from the unloader.

5. Crankshaft rotation on Giant Industries, Inc. pumps should be made in the direction designated by the arrows on the pump crankcase. Reverse rotation may be safely achieved by following a few guidelines available upon request from Giant Industries, Inc. Required horsepower for system operation can be obtained from the charts on page 3.

6. Before beginning operation of your pumping system, remember: Check that the crankcase and seal areas have been properly lubricated per recommended schedules. Do not run the pump dry for extended periods of time. Cavitation will result in severe damage. Always remember to check that all plumbing valves are open and that pumped media can flow freely to the inlet of the pump.

MP SERIES -- PUMP SPECIFICATIONS

U.S. Measurements

	Max. Flow	Max. Pressure	Max. Speed	Power Req'd.	Max. Temperature	Plunger Diameter	NPSH Required
Model	GPM	PSI	RPM	HP	F	in	Ft-Head
MP4120	8.9	3625	1450	23.1	160	0.787	24.6
MP4124	12.8	2610	1450	24	160	0.945	27.9
MP4135	13.5	1885	1100	18.2	160	1.1	29.5
MP4130	15.4	1600*	1100	17.6	160	1.2	29.5
MP4130HK	15.4	1600	1100	17.6	195	1.2	N/A

* Intermittent rating of 2000 PSI

Metric Measurements

	Max. Flow	Max. Pressure	Max. Speed	Power Req'd.	Max. Temperature	Plunger Diameter	NPSH Required
Model	L/min	Bar	RPM	kW	C	mm	mWs
MP4120	33.8	250	1450	17.2	70	20	7.5
MP4124	48.6	180	1450	17.9	70	24	8.5
MP4135	51.2	130	1100	13.6	70	28	9
MP4130	58.2	110*	1100	13.1	70	30	9
MP4130HK	58.2	110	1100	13.1	90	30	N/A

* Intermittent rating of 140 Bar

Consult the factory for special requirements that must be met if the pump is to operate beyond one or more of the limits specified above.

Horsepower Ratings:

We recommend a 1.15 service factor be specified when selecting an electric motor as the power source.
 To compute electric motor horsepower required, use the following formula: $HP = (GPM \times PSI) / 1450$.
 The formula to determine the horsepower required for a gas engine is: $HP = (GPM \times PSI) / 1150$.
 The formula to determine the horsepower required for a diesel engine is: $HP = (GPM \times PSI) / 1250$.

For the Application of a Hydraulic Motor:

To Determine the Torque of a Hydraulic Motor -- $(GPM \times PSI \times 36.77) / RPM = \text{Torque (in-lbs)}$

Calculating RPM / GPM of Pump:

A pump must be connected to an electric motor or gas or diesel engine with the correct ratio of pulleys and belts to attain the required speed and GPM. The use of a Variable Frequency Drive (VFD) may also be used to control the RPM of a properly sized electric motor when variable flows are required.

$$(\text{Max. Pump RPM} / \text{Rated Pump GPM}) \times \text{Required Pump GPM} = \text{Required Pump RPM}$$

To calculate a pulley diameter one (1) pulley diameter and the required pump RPM must be known:

$$(\text{Pump RPM} \times \text{Pump Pulley Diameter}) / \text{Motor RPM} = \text{Motor Pulley Diameter}$$

$$(\text{Motor RPM} \times \text{Motor Pulley Diameter}) / \text{Pump RPM} = \text{Pump Pulley Diameter}$$

Common Specifications:

Inlet Pressure.....145 PSI (10 Bar)
 Crankshaft Diameter.....1.10" (28mm)
 Crankcase Oil Capacity.....32 fl. oz. (1.0 L)
 Inlet Ports.....(2) 1" NPT
 Discharge Ports.....(2) 3/4" NPT
 Stroke.....1.02" (26mm)
 Weight.....66 lbs (30kg)
 Shaft Rotation.....Top of Pulley Toward Fluid End

Materials Used for MP Pumps:

Manifold Aluminum Bronze
 Plungers Solid Ceramic Oxide
 Valves High Grade Stainless Steel
 Seals..... Nitrile with Fabric Reinforcing
 Gear End Spheroidal Cast Iron

Exploded View - MP Series

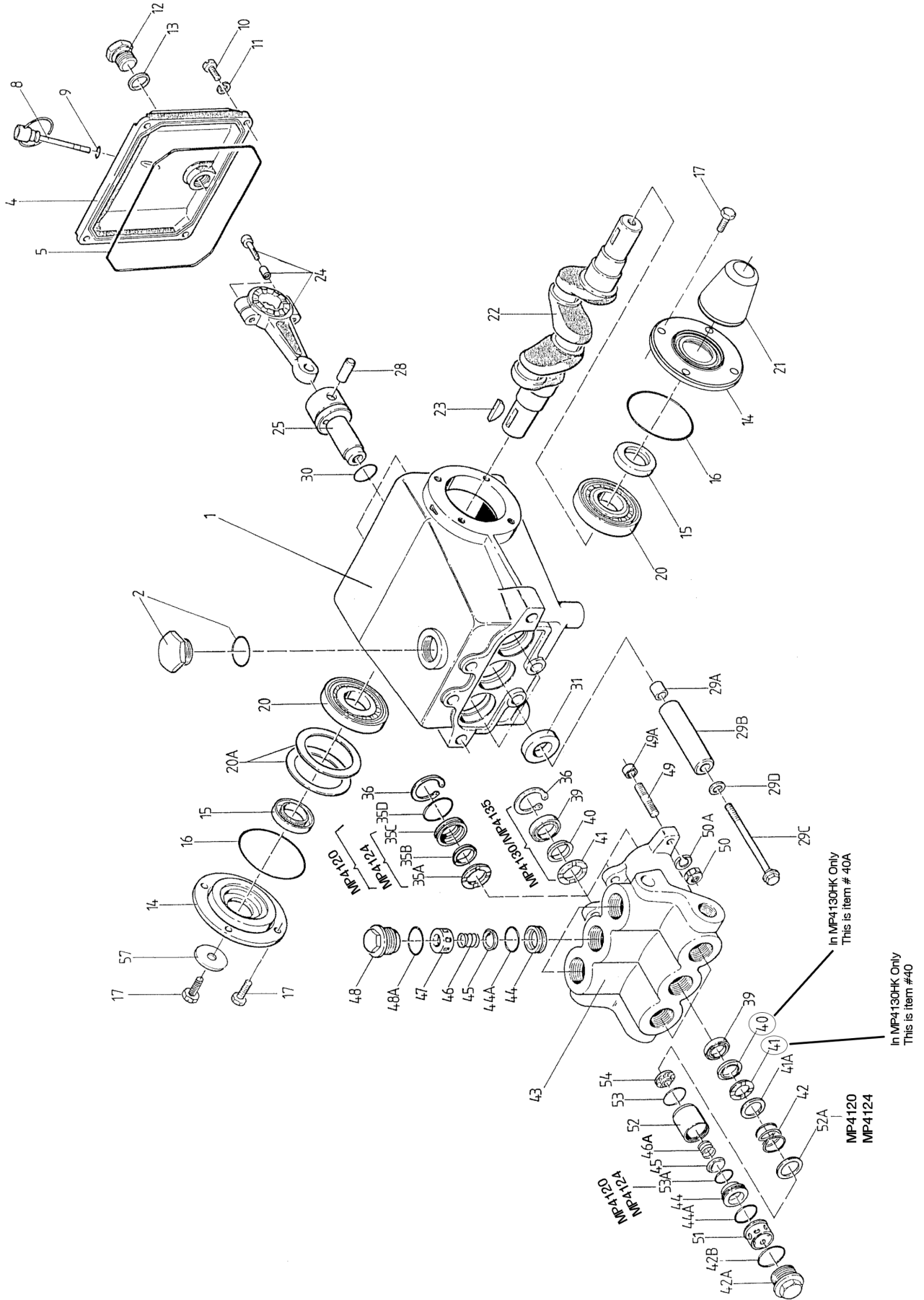

MP SERIES PARTS LIST AND REPAIR KITS

ITEM	PART #	DESCRIPTION	QTY.	ITEM	PART#	DESCRIPTION	QTY.
1	06100	Crankcase	1	40	06083	V-Sleeve (MP4124W)	3
2	13000	Oil Filler Cap Assembly	1	40	07272	V-Sleeve (MP4130W)	6
4	07243	Cover, Crankcase	1	40	05687	V-Sleeve (MP4135W)	6
5	07244	O-Ring, Crankcase Cover	1	40	06137	V-Sleeve (MP4130HK)	6
8	01008	Oil Dip Stick	1	40A	07272	V-Sleeve (MP4130HK)	3
9	01009	O-Ring, Dip Stick	1	41	07270	Support Ring (MP4120W)	3
10	01010	Screw, Crankcase Cover	4	41	06084	Support Ring (MP4124W)	3
11	01011-0400	Spring Washer	4	41	07273	Support Ring (MP4130W)	6
12	07109	Oil Drain Plug	1	41	06652	Support Ring (MP4135W)	6
13	07182	Gasket, Oil Drain Plug	1	41A	07329	Spacer (MP4120W, MP4124W)	3
14	07245	Bearing Cover	2	41A	07274	Intermediate Ring (MP4130W, MP4135W)	3
15	07247	Seal, Crankshaft	2	42	07275	Tension Spring (MP4120W/MP4124W)	3
16	07627	O-Ring, Bearing Cover	2	42	07353	Tension Spring (MP4130W, MP4135W)	3
17	07114	Hex Screw, Bearing Cover	9	42A	06102	Tension Plug (MP4120W/MP4124W)	3
20	07248	Roller Bearing, Tapered	2	42A	06103	Tension Plug (MP4130W, MP4135W)	3
20A	07249	Shim	2	42B	07332	O-Ring (MP4120W/MP4124W)	3
20B	06962	Fitting Disc	2	42B	07354	O-Ring, Tension Plug (MP4130W, MP4135W)	3
21	07250	Shaft Protector	1	43	06104	Manifold Head (MP4120W/MP4124W)	1
22	07251	Crankshaft	1	43	06105	Manifold Head (MP4130W, MP4135W)	1
23	07252	Key	1	44	07280	Valve Seat	6
24	07253	Connecting Rod	3	44A	07281	O-Ring, Valve Seat	6
25	07596	Crosshead Complete	3	45	07282	Valve Plate	6
28	07255	Crosshead Pin	3	46	07283	Discharge Valve Spring	3
29A	07256	Centering Sleeve	3	46A	06959	Inlet Valve Spring	3
29B	07262	Ceramic Plunger, 20mm (MP4120W)	3	47	07284	Spring Retainer, Discharge	3
29B	13046	Ceramic Plunger, 24mm (MP4124W)	3	48	06108	Plug, S.S. (MP4120W, MP4124W)	3
29B	07261	Ceramic Plunger, 30mm (MP4130W, MP4130HK)	3	48	07356	Plug, Brass (MP4130W, MP4135W)	3
29B	13005	Ceramic Plunger, 28mm (MP4135W)	3	48A	07332	O-Ring, Plug	3
29C	13007	Bolt, Sold only w/#07258	3	49	06109	Stud, Manifold	6
29D	07258	Seal Washer	3	49A	07319	Shim, Stud	2
30	06136	Flinger	3	50	07158	Nut, Manifold Stud	6
31	07260	Crankcase Oil Seal	3	50A	07159	Spring Washer	6
35A	07263	Rear Support Ring (MP4120W)	3	51	06110	Spacer	3
35A	06079	Rear Support Ring (MP4124W)	3	52	06111	Valve Housing (MP4120W/MP4124W)	3
35B	06064	Rear V-Sleeve (MP4120W)	3	52	06112	Valve Housing (MP4130W)	3
35B	06080	Rear V-Sleeve (MP4124W)	3	52A	07329	Spacer Ring (MP4120W)	3
35C	07265	Rear Pressure Ring (MP4120W)	3	53	12057	O-Ring (MP4120W/MP4124W)	3
35C	06081	Rear Pressure Ring (MP4124W)	3	53	07332	O-Ring (MP4130W)	3
35D	07266	Rear O-Ring (MP4120W)	3	53A	12027	O-ring (MP4120W)	3
36	07267	Snap Ring	3	54	06115	Spring Retainer, Inlet	3
39	07268	Pressure Ring (MP4120W)	3	57	13020	Disc for Crankshaft	1
39	06082	Pressure Ring (MP4124W)	3				
39	07271	Pressure Ring (MP4130W)	6				
39	13013	Pressure Ring (MP4135W)	6				
40	07322	V-Sleeve (MP4120W)	3				

Plunger Packing Kits

MP4120W # 09044

Item	Part #	Description	Qty
40	07322	V-Sleeve	3
35B	06064	Rear V-Sleeve	3

MP4124W # 09300

Item	Part #	Description	Qty
40	06083	V-Sleeve	3
35B	06080	Rear V-Sleeve	3

MP4130W # 09042

Item	Part #	Description	Qty
40	07272	V-Sleeve	6

MP4135W # 09665

Item	Part #	Description	Qty
40	05687	V-Sleeve	6

MP4130HK # 09664

Item	Part #	Description	Qty
40	06137	V-Sleeve, High Temp	6
40A	07272	V-Sleeve	3

Inlet Valve Assembly Kit

09062

Item	Part #	Description	Qty
42B	07354	O-Ring Tension Plug	3
42B	07332	O-Ring Tension Plug	3
44	07280	Valve Seat	3
44A	07281	O-Ring, Valve-Seat	3
45	07282	Valve Plate	3
46A	06959	Valve Spring	3
53	12057	O-Ring	3
53A	12027	O-Ring	3
54	06115	Spring Retainer	3

Discharge Valve Assembly Kit # 09043

Item	Part #	Description	Qty
42B	07332	O-Ring, Tension Plug	3
44	07280	Valve Seat	3
44A	07281	O-Ring	3
45	07282	Valve Plate	3
46	07283	Valve Spring	3
47	07284	Spring Retainer	3

PUMP SYSTEM MALFUNCTION

<u>MALFUNCTION</u>	<u>CAUSE</u>	<u>REMEDY</u>
The Pressure and/or the Delivery Drops	Worn packing seals	Replace packing seals
	Broken valve spring	Replace spring
	Belt slippage	Tighten or Replace belt
	Worn or Damaged nozzle	Replace nozzle
	Fouled discharge valve	Clean valve assembly
	Fouled inlet strainer	Clean strainer
	Worn or Damaged hose	Repair/Replace hose
	Worn or Plugged relief valve on pump	Clean, Reset, and Replace worn parts
	Cavitation	Check suction lines on inlet of pump for restrictions
	Unloader	Check for proper operation
Water in crankcase	High humidity	Reduce oil change interval
	Worn seals	Replace seals
Noisy Operation	Worn bearings	Replace bearings, Refill crankcase oil with recommended lubricant
	Cavitation	Check inlet lines for restrictions and/or proper sizing
Rough/Pulsating Operation with Pressure Drop	Worn packing	Replace packing
	Inlet restriction	Check system for stoppage, air leaks, correctly sized inlet plumbing to pump
	Accumulator pressure	Recharge/Replace accumulator
	Unloader	Check for proper operation
Pressure Drop at Gun	Cavitation	Check inlet lines for restrictions and/or proper size
	Restricted discharge plumbing	Re-size discharge plumbing to flow rate of pump
Excessive Leakage	Worn plungers	Replace plungers
	Worn packing/seals	Adjust or Replace packing seals
	Excessive vacuum	Reduce suction vacuum
	Cracked plungers	Replace plungers
High Crankcase Temperature	Inlet pressure too high	Reduce inlet pressure
	Wrong Grade of oil	Giant oil is recommended
	Improper amount of oil in crankcase	Adjust oil level to proper amount

REPAIR INSTRUCTION - MP SERIES

Disassembly sequence of the GIANT MP Series Pumps

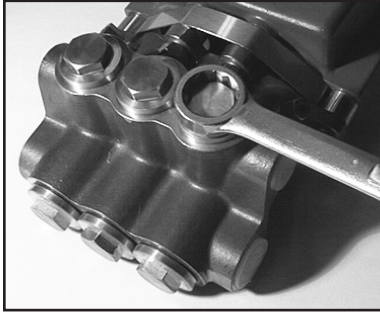

1. With a 27mm wrench, remove the three discharge plugs (#48) and three inlet plugs (#42A) from the manifold (#43).



2. Inspect the plug o-rings (#48A and #42B) and replace as necessary.

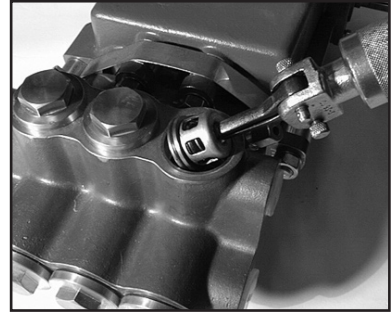

3. From the discharge port remove the spring retainer (#47) spring (#46) and the valve plate (#45). Using the valve puller (Available from Snap-On Tools) remove the valve seat (#44)

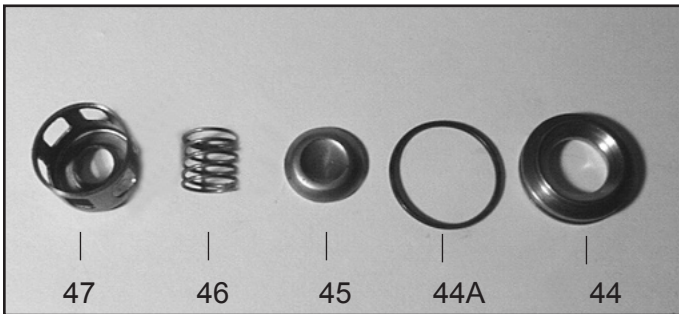

4. Inspect all parts, especially the seating surface of the valve plate (#45), and replace as necessary.

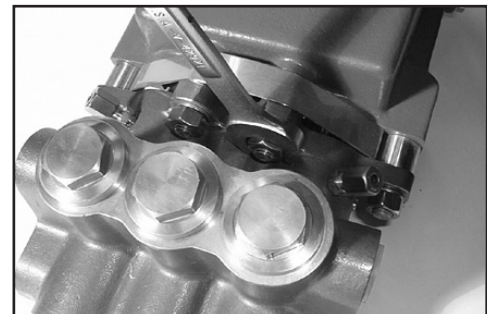

5. Remove the six manifold stud nuts (#50) with a 19mm wrench. Remove the spring washers (#50A). Tap the back of the manifold with a rubber mallet to dislodge and slide it off the studs (#49). The spacer (#51) can now be removed by prying gently outward with a screwdriver through the front of the inlet port.

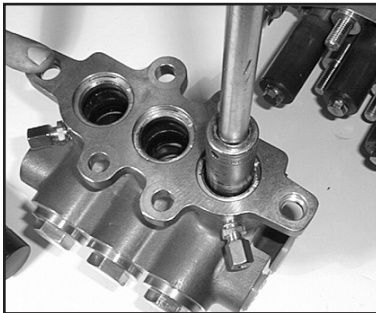

6. To remove the inlet valve assembly, insert a 13mm socket with extension through the rear of the inlet manifold (#43) port and tap it firmly with a hammer. This will force the tension spring (#46A), valve housing (#52) and the remainder of the inlet valve assembly out through the front of the inlet port.

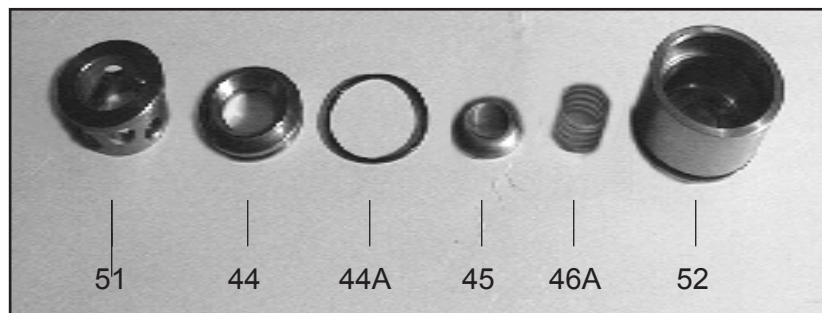

7. Pull the inlet valve assembly apart for inspection. Any resistance may be overcome by placing the valve housing (#52) in a brass jawed vise and carefully tapping the back of the valve plate (#45) with a screwdriver. Inspect the valve seats (#44), spring (#46A), o-ring (#44A) and o-ring (#53A for MP4120W/MP4124W) for wear and replace them as necessary.

REPAIR INSTRUCTION - MP SERIES

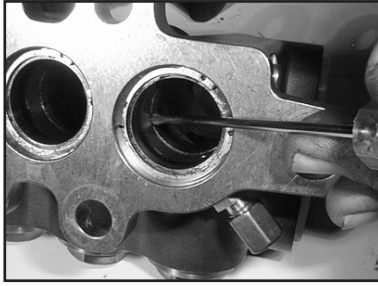

8. From the front of the manifold (#43), remove the packing assembly (#41A, 41, 40, and 39). Use a small slide hammer puller if necessary, or insert a wooden dowel through the back of the manifold and tap the assembly out from the back to the front.

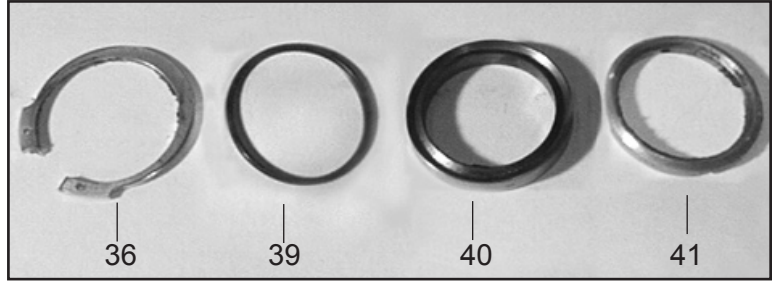

9. Turn the manifold (#43) over and remove the rear v-sleeve snap ring (#36). For MP4120W/MP4124W, remove the rear o-ring (#35D). Remove the rear pressure ring (#35C-MP4120W/MP4124W & #39-MP4130W/MP4135W), rear v-sleeve (#35B-MP4120W/MP4124W & #40-MP4130W/MP4135W) and rear support ring (#35A-MP4120W/MP4124W & #41-MP4130W/MP4135W) These parts should slide out with little resistance. If necessary, a screwdriver may be used to pry outward. Replace all rubber parts and inspect the metal parts for wear.

10. **Note: The following procedure is only necessary if a stud bolt (#49) has been damaged and must be replaced.** To remove the manifold studs (#49), place a stud nut (#50), lock washer (#50A), and second nut on each stud. Tighten the nuts against each other. Hold the front nut with one wrench, and remove the stud bolt by turning the rear nut counterclockwise with another wrench. To reassemble, turn the front stud bolt nut clockwise.

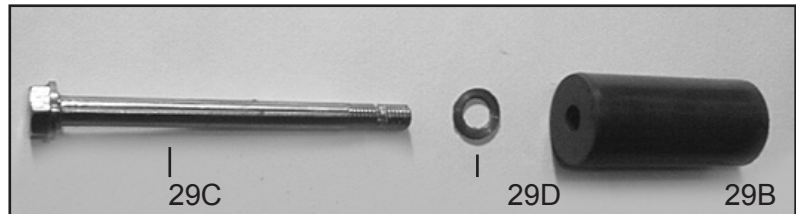

11. Inspect ceramic plunger pipe (29B). Clean any dirt or grime. If the surface of the pipe is rough, scored or pitted, replace plunger pipe. To remove the ceramic plunger pipe, turn the plunger bolt (#29C) counterclockwise with a 13mm socket. Use a steady torque to prevent ceramic plunger pipe damage. Loosen and remove the plunger bolt assembly (#29C and #29D) and replace the seal washer (#29D).

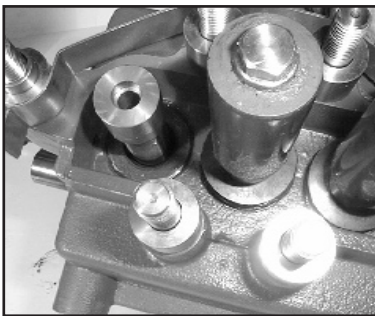

12. Inspect the crankcase oil seals (#31) for evidence of leaking. If there is oil on the crankcase (#1) at the sight of the oil seals, they must be replaced. The oil seals are replaced after removing the crosshead/plunger assembly (#25) as described on page 9.

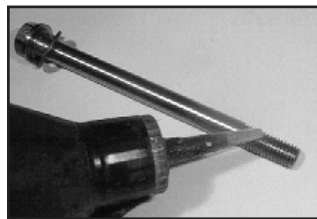

13. Clean the bolt threads (#29C), apply locktite, and remount.

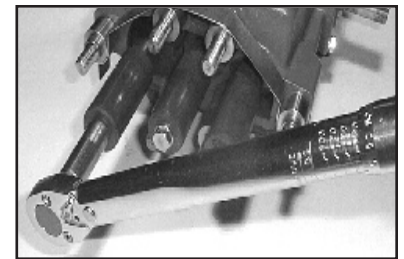

14. Torque the ceramic plunger bolt assembly to 300 inch-pounds (34 Nm). If originally removed, reinstall the stud bolts (#49).

REPAIR INSTRUCTIONS - MP SERIES

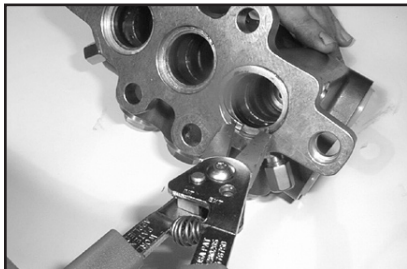

15. Replace the rear support ring (#35A for MP4120W/MP4124W and #41 for MP4130W/MP4135W). Replace the rear v-sleeve (#35B for MP4120W/MP4124W and #40 for MP4130W/MP4135W) and rear pressure ring (#35C for MP4120W/MP4124W and #39 for MP4130W/MP4135W) making sure that the grooved side is facing the discharge end of the manifold (#43). For MP4120W/MP4124W, replace the rear o-ring (#35D) into the back of the manifold (#43). Replace the snap ring (#36).

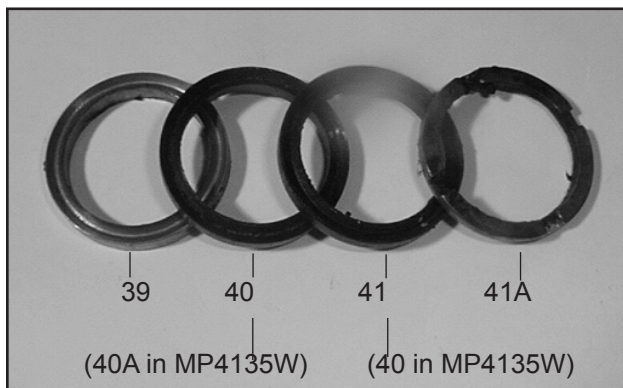

16. Reinstall the pressure ring (#39), v-sleeve (#40 / #40A for MP4135W), support ring (#41 / #40 for MP4135W) and intermediate ring (#41A) into each plunger bore. Re-install the tension spring (#42). For MP4120W/MP4124W only replace the spacer ring (#52A).

17. Reassemble the inlet valve assembly in the reverse order of step #6. Make certain all the components are press fit together and that the spring retainer (#54) is slightly counter sunk in the valve housing (#52). Grease the o-ring (#53) and replace it on to the valve housing. Reinstall the entire inlet valve assembly into the manifold (#43). Replace the tension plugs (#42A) and tighten.



18. Reassemble the discharge valve assembly by placing the valve plate (#45), spring (#46), and spring retainer (#47) on top of the valve seat (#44). Press fit together. Place the entire discharge assembly into discharge port making certain the assembly is properly seated. Replace discharge plug (#48) and tighten securely.
19. Again lubricate the plungers (29B) and slide the manifold (#43) gently and evenly over the plungers. Press the manifold firmly into place against the crankcase (#1). Replace the spring washer (#50A) and tighten the manifold stud nuts (#50) to 700 inch-pounds (79 Nm).

REPAIR INSTRUCTIONS - MP SERIES

Gear End Disassembly

20. Remove the manifold and plunger assemblies as described earlier. Make sure the oil is drained from the pump before removing the crankcase cover (#4). Remove all screws (#10). Inspect the crankcase cover o-ring (#5) for damage and replace it as necessary.
21. Remove the connecting rod screws and washers with a 6mm allen wrench. Remove the back halves of each connecting rod (#24) . Push the connecting rods down as far as possible into the crankcase (#1) housing. Note that the connecting rod halves are numbered (or colored) and that the numbers (or colors) must be matched for reassembly.
22. Remove the crankshaft bearing cover screws (#17) with a 13mm wrench. Remove the key (#23) from the crankshaft (#22).
23. Remove the bearing cover (#14) and any shims (#20A) if any. **Remember to replace shims on the same side of the crankcase (#1) during the reassembly.**
24. Steady the pump rear assembly and, using a rubber mallet, tap the crankshaft (#22) from one side. The far side bearing race will be removed and the near side race will remain in the crankcase. The roller bearings (#20) will remain on the crankshaft. When both ends are free, the crankshaft can be removed by hand.
25. To remove the remaining bearing race, place a dowel against the inside edge of the race and tap it out with a rubber mallet. This is done only if the race wear surface has been damaged.
26. Inspect the bearing race removed with the crankshaft (#22) and replace if wear surface is damaged.
27. **Note: The following procedure is only necessary if the inspection shows evidence of heavy wear.** Inspect the crankshaft (#22) and bearings (#20) for wear. To remove the roller bearings from the crankshaft, use a three inch push puller with a pulley attachment. To remount the bearings, tap the bearings down the well-lubricated crankshaft with the Giant Bearing Tool. Be sure that the bearing is firmly seated.
28. Remove the connecting rod (#24) with the attached crosshead/plunger assembly (#25) from the crankcase (#1) by pulling it straight out. The oil seals (#31) may now be removed by tapping them out through the front of the crankcase. Be careful not to damage the snap ring.
29. Inspect the surfaces of the crosshead/plunger assembly (#25) and connecting rods (#24) for heavy scoring or galling due to poor lubrication. Check for play at the joint between connecting rod crosshead/plunger assembly.
30. To remove the crosshead pin (#28) from the crosshead/plunger assembly (#25), the assembly should be positioned in such a manner to prevent damage to the crosshead when driving the pin out. The crosshead pin can be driven out by tapping on the tapered side of the pin.

Reassembly Sequence

- Note:** Always take time to lubricate all metal and nonmetal parts with a light film of oil before reassembly. This step will help ensure a proper fit, at the same time it will protect the pump non-metal parts (elastomers) from cutting and scoring.
31. Take the crosshead/plunger rod assembly and insert the connecting rod (#24) into the crosshead/plunger assembly (#25). Drive the tapered end of the crosshead pin (#28) into the beveled side of the crosshead and through the connecting rod completing the assembly.
- Note:** The crosshead pin should not extend beyond either side of the crosshead in order to prevent damage to the crosshead bore of the crankcase.
32. Inspect the crankcase crosshead guides for any possible damage.
 33. Replace the connecting rod (#24), crosshead/plunger rod assembly (#25) into the crankcase (#1).
 34. If removed previously, replace the far side bearing race into the crankcase. Tap with a rubber mallet until the edges are flush with the crankcase surface.
 35. Remove the old crankshaft seal (#15) from the bearing cover (#14). Lubricate the edges of the new seal and install using the standard Giant Bearing Tool. Remove the bearing tool and tap around the perimeter of the seal with a rubber mallet to firmly seat the seal. Position the far bearing cover on the crankcase (#1) and insert the cover bolts (#17). Tighten the cover evenly to the crankcase, setting the bearing into position. Torque the cover bolts to 125 inch-pounds (14 Nm).

REPAIR INSTRUCTIONS - MP SERIES

Reassembly Sequence

36. Insert the crankshaft (#22) with the mounted bearings (#20) through the near side of the crankcase (#1). Make certain that the numbers (or colors) or the crankshaft correspond to the numbers (or colors) on the connecting rods (#24). Reinstall the near side bearing race by inserting it into the crankcase. Supporting the crankshaft with one hand, tap the race with a rubber mallet until the edge is flush with the crankcase.
37. Replace any shims (#20A, 20B) and position the bearing cover (#14) as before. Tighten the bearing cover bolts (#17) evenly to position the bearing race. Torque the bolts to 125 inch-pounds. Once the crankshaft reassembly is complete, oil the crankshaft races freely before replacing the connecting rod (#24) end caps.
38. Reassemble the connecting rods (#24), matching the numbered (or colored) halves. Torque the connecting rod bolts (#24A) to 250 inch-pounds (28 Nm).
39. To replace the oil seal (#31) apply Loctite to the outside edges of the seal and install from the front of the crankcase (#1). The side of the seal with the spring must face the oil. Make sure that the face of the seal is flush with the crankcase.
40. Clean the back edge of the crankcase and replace the crankcase cover (#4). be careful not to pinch the crankcase cover o-ring (#5).
41. Fill the crankcase with 32 fluid ounces of Giant oil or the equivalent SAE 85W-140 Industrial Gear oil and check the oil level with the dip stick (#8). The proper level is center of the two lines. Reinstall the Giant MP Series pump into your system.

MP SERIES TORQUE SPECIFICATIONS

<u>Position</u>	<u>Item#</u>	<u>Description</u>	<u>Torque Amount - in.-lbs. (Nm)</u>
17	07114	Hex Screw, Bearing Cover	125 (14)
24	07253	Hex Screw, Connecting Rod	250 (28)
29C	13007	Bolt, Plunger	300 (34)
50	07158	Nut, Manifold Stud	700 (79)

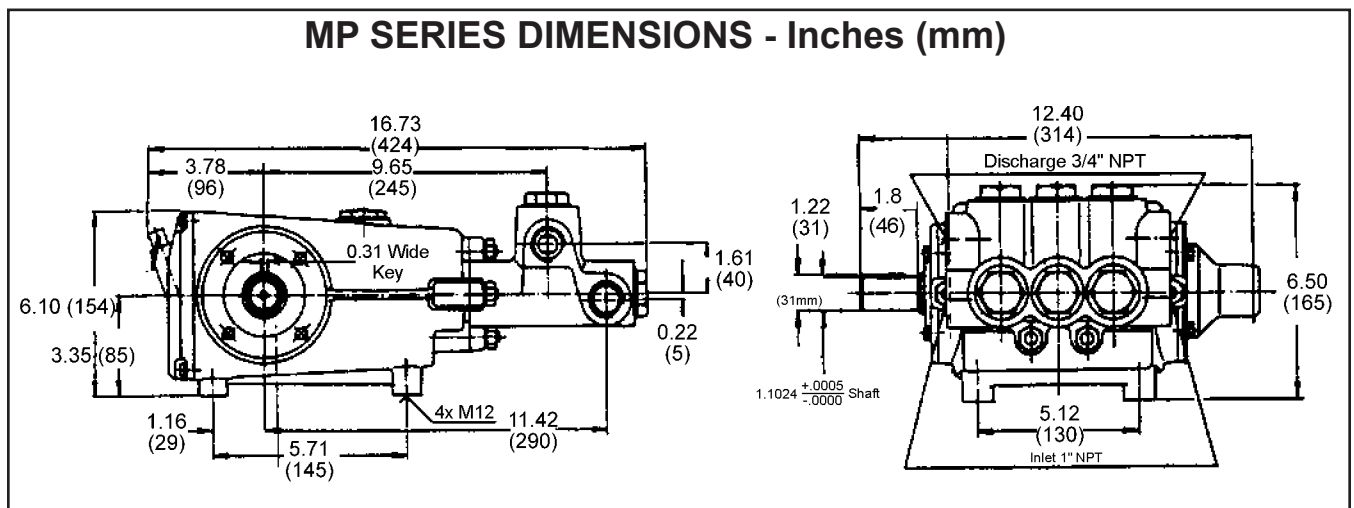

**NOTE: Contact Giant Industries for
Service School Information.
Phone: (419)-531-4600**

GIANT INDUSTRIES LIMITED WARRANTY

Giant Industries, Inc. pumps and accessories are warranted by the manufacturer to be free from defects in workmanship and material as follows:

1. For portable pressure washers and self-service car wash applications, the discharge manifolds are guaranteed for the life of the pump. Our other pump parts, used in portable pressure washers and in car wash applications, are warranted for five years from the date of shipment for all pumps used in NON-SALINE, clean water applications.
2. One (1) year from the date of shipment for all other Giant industrial and consumer pumps.
3. Six (6) months from the date of shipment for all rebuilt pumps.
4. Ninety (90) days from the date of shipment for all Giant accessories.

This warranty is limited to repair or replacement of pumps and accessories of which the manufacturer's evaluation shows were defective at the time of shipment by the manufacturer. The following items are NOT covered or will void the warranty:

1. Defects caused by negligence or fault of the buyer or third party.
2. Normal wear and tear to standard wear parts.
3. Use of repair parts other than those manufactured or authorized by Giant.
4. Improper use of the product as a component part.
5. Changes or modifications made by the customer or third party.
6. The operation of pumps and or accessories exceeding the specifications set forth in the Operations Manuals provided by Giant Industries, Inc.

Liability under this warranty is on all non-wear parts and limited to the replacement or repair of those products returned freight prepaid to Giant Industries which are deemed to be defective due to workmanship or failure of material. A Returned Goods Authorization (R.G.A.) number and completed warranty evaluation form is required prior to the return to Giant Industries of all products under warranty consideration. Call (419)-531-4600 or fax (419)-531-6836 to obtain an R.G.A. number.

Repair or replacement of defective products as provided is the sole and exclusive remedy provided hereunder and the MANUFACTURER SHALL NOT BE LIABLE FOR FURTHER LOSS, DAMAGES, OR EXPENSES, INCLUDING INCIDENTAL AND CONSEQUENTIAL DAMAGES DIRECTLY OR INDIRECTLY ARISING FROM THE SALE OR USE OF THIS PRODUCT.

THE LIMITED WARRANTY SET FORTH HEREIN IS IN LIEU OF ALL OTHER WARRANTIES OR REPRESENTATION, EXPRESS OR IMPLIED, INCLUDING WITHOUT LIMITATION ANY WARRANTIES OR MERCHANTABILITY OR FITNESS FOR A PARTICULAR PURPOSE AND ALL SUCH WARRANTIES ARE HEREBY DISCLAIMED AND EXCLUDED BY THE MANUFACTURER.

