

Models LP301A, LP301A-4000, LP600 and LP600-4000

Triplex Ceramic
Plunger Pump
Operating Instructions/
Manual

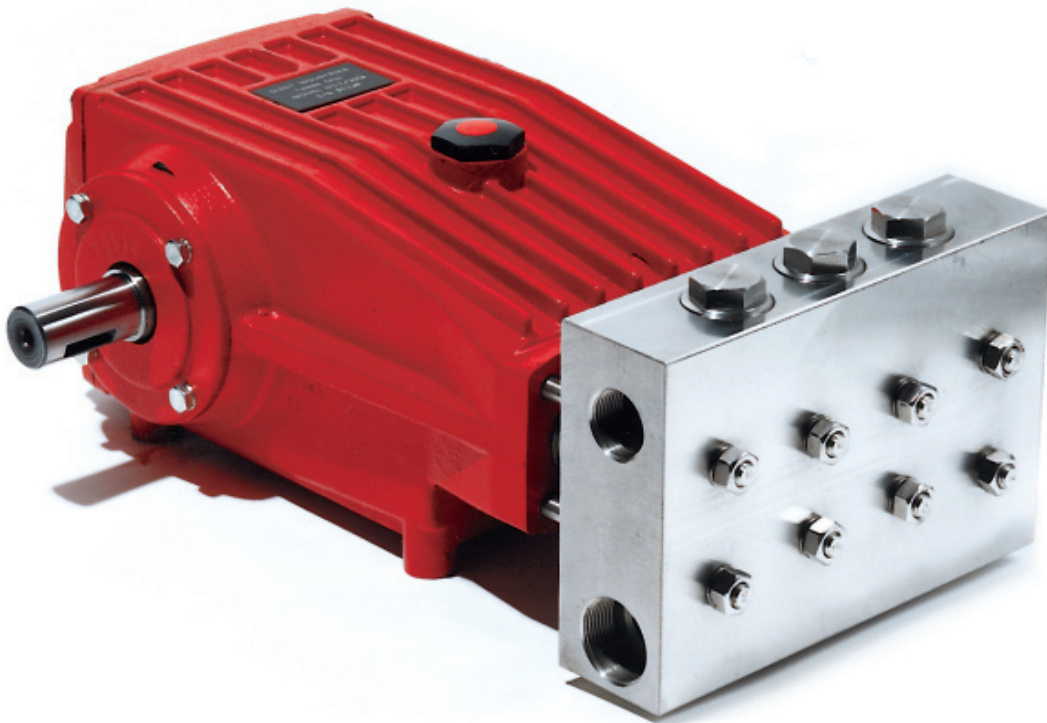

Contents:	
Installation Instructions:	page 2
LP301A/LP600 Specifications:	page 3
Exploded View:	page 4
Parts List:	page 5
Repair Kits:	page 6
Repair Instructions:	page 7-10
Pump Mounting Selection Guide:	page 10
Torque Specifications:	page 10
Trouble Shooting/Preventative Maintenance Check-List & Recommended Spare Parts List:	page 11
Dimensions:	back page
Warranty Information:	back page

Updated 11/13

INSTALLATION INSTRUCTIONS

Installation of the Giant Industries, Inc., pump is not a complicated procedure, but there are some basic steps common to all pumps. The following information is to be considered as a general outline for installation. If you have unique requirements, please contact Giant Industries, Inc. or your local distributor for assistance.

1. The pump should be installed flat on a base to a maximum of a 15 degree angle of inclination to ensure optimum lubrication.
2. The inlet to the pump should be sized for the flow rate of the pump with no unnecessary restrictions that can cause cavitation. Teflon tape should be used to seal all joints. If pumps are to be operated at temperatures in excess of 140° F, it is important to insure a positive head to the pump to prevent cavitation.
3. The discharge plumbing from the pump should be properly sized to the flow rate to prevent line pressure loss to the work area. It is essential to provide a safety bypass valve between the pump and the work area to protect the pump from pressure spikes in the event of a blockage or the use of a shut-off gun.

4. Use of a dampener is necessary to minimize pulsation at drive elements, plumbing, connections, and other system areas. The use of a dampener with Giant Industries, Inc. pumps is optional, although recommended by Giant Industries, Inc. to further reduce system pulsation. Dampeners can also reduce the severity of pressure spikes that occur in systems using a shut-off gun. A dampener must be positioned downstream from the unloader.
5. Crankshaft rotation on Giant Industries, Inc. pumps should be made in the direction designated by the arrows on the pump crankcase. Reverse rotation may be safely achieved by following a few guidelines available upon request from Giant Industries, Inc. Required horsepower for system operation can be obtained from the charts on pages 3 and 6.

6. Before beginning operation of your pumping system, remember: Check that the crankcase and seal areas have been properly lubricated per recommended schedules. Do not run the pump dry for extended periods of time. Cavitation will result in severe damage. Always remember to check that all plumbing valves are open and that pumped media can flow freely to the inlet of the pump.

Finally, remember that high pressure operation in a pump system has many advantages. But, if it is used carelessly and without regard to its potential hazard, it can cause serious injury.

IMPORTANT OPERATING CONDITIONS

Failure to comply with any of these conditions invalidates the warranty.

1. Prior to initial operation, add oil to the crankcase so that oil level is between the two lines on the oil dipstick. **DO NOT OVERFILL.**

Use SAE 85-140 industrial gear oil

Crankcase oil should be changed after the first 50 hours of operation, then at regular intervals of 500 hours or less depending on operating conditions.

2. Pump operation must not exceed rated pressure, volume, or RPM. A pressure relief device must be installed in the discharge of the system.

3. Acids, alkalines, or abrasive fluids cannot be pumped unless approval in writing is obtained before operation from Giant Industries, Inc.

4. Run the pump dry approximately 10 seconds to drain the water before exposure to freezing temperatures.

NOTE: Contact Giant Industries for Service School Information. Phone: (419)-531-4600

Model LP301A/LP301A-4000 Specifications

	<u>U.S.</u>	<u>Metric</u>
Ratings (continuous).....	14.2 GPM @ 4000 PSI @ 1000 RPM.....	53.6 LPM
Ratings (intermittent).....	18 GPM @ 4000 PSI @ 1268 RPM.....	68.1 LPM
Inlet Pressure	-4.35 to 145 PSI	-0.3 to 10 Bar
Plunger Diameter.....	0.95".....	24 mm
Stroke	1.65".....	42 mm
Crankcase Oil Capacity	118 fl.oz.....	3.5 Liters
Temperature of Pumped Fluids	140 °F.....	60 °C
Inlet Port		1-1/4" BSP
Discharge Port.....		1" BSP
Crankshaft Mounting		Either Side
Shaft Rotation.....		Top of Pulley Towards Fluid End
Weight	119 lbs.....	54 kg
Crankshaft Diameter.....		35 mm

Model LP600/LP600-4000 Specifications

	<u>U.S.</u>	<u>Metric</u>
Volume.....	Up to 9.8 GPM.....	37 LPM
Discharge Pressure	5800 PSI.....	400 Bar
Inlet Pressure	-4.35 to 145 PSI	0.3 to 10 Bar
Speed		1000 RPM
Plunger Diameter.....	0.79"	20 mm
Stroke	1.65"	42 mm
Crankcase Oil Capacity	118 fl.oz.....	3.5 liters
Temperature of Pumped Fluids	140 °F.....	60 °C
Inlet Port		1-1/4" BSP
Discharge Port.....		1" BSP
Crankshaft Mounting		Either Side
Shaft Rotation.....		Top of Pulley Towards Fluid End
Weight	119 lbs.....	54 kg
Crankshaft Diameter.....		35 mm

* Intermittent duty for pump speeds in excess of 805 RPM

PULLEY INFORMATION

Pulley selection and pump speed are based on a 1725 RPM motor and "B" section belts. When selecting desired GPM, allow for a ±5% tolerance on pumps output due to variations in pulleys, belts and motors among manufacturers.

1. Select GPM required, then select appropriate motor and pump pulley from the same line.
2. The desired pressure is achieved by selecting the correct nozzle size that corresponds with the pump GPM.

HORSEPOWER INFORMATION

We recommend that a 1.15 service factor be specified when selecting an electric motor as the power source. To compute specific pump horsepower requirements, use the following formula:

$$HP = (GPM \times PSI) / 1450$$

LP301A PULLEY SELECTION AND HORSEPOWER REQUIREMENTS					
RPM	GPM	2500 PSI	3000 PSI	3500 PSI	4000 PSI
500	7.05	12.2	14.6	17.0	19.4
640	9.02	15.6	18.7	21.8	24.9
750	10.57	18.2	21.9	25.5	29.2
805	11.35	19.6	23.5	27.4	31.3
865	12.2	21.0	25.2	29.4	33.7
940	13.25	22.8	27.4	32.0	36.6
1000	14.2	24.5	29.4	34.3	39.2
1268	18.0*	31.0	37.2	43.4	49.7*

LP600 PULLEY SELECTION AND HORSEPOWER REQUIREMENTS					
GPM	RPM	3000 PSI	4000 PSI	5000 PSI	5800 PSI
4.85	500	10.1	13.5	16.8	19.4
6.2	640	12.9	17.2	21.5	24.8
7.28	750	15.2	20.2	25.3	29.1
7.8	805	16.3	21.6	27.1	31.2
8.4	865	17.5	23.3	29.1	33.6
9.1	940	18.9	25.2	31.6	36.4
9.7	1000	20.2	26.9	33.7	38.8

* Intermittent duty only

Exploded View

LP301A/LP301A-4000/LP600/LP600-4000

Important! The stainless steel valve plugs (48) can seize when being screwed out of the casing. To release tension beforehand, strike the plugs 1-2 times with a steel hammer on the top before screwing them out. Coat threads with antiseize (e.g. Fel-Pro Nickel Anti-Seize 51119)

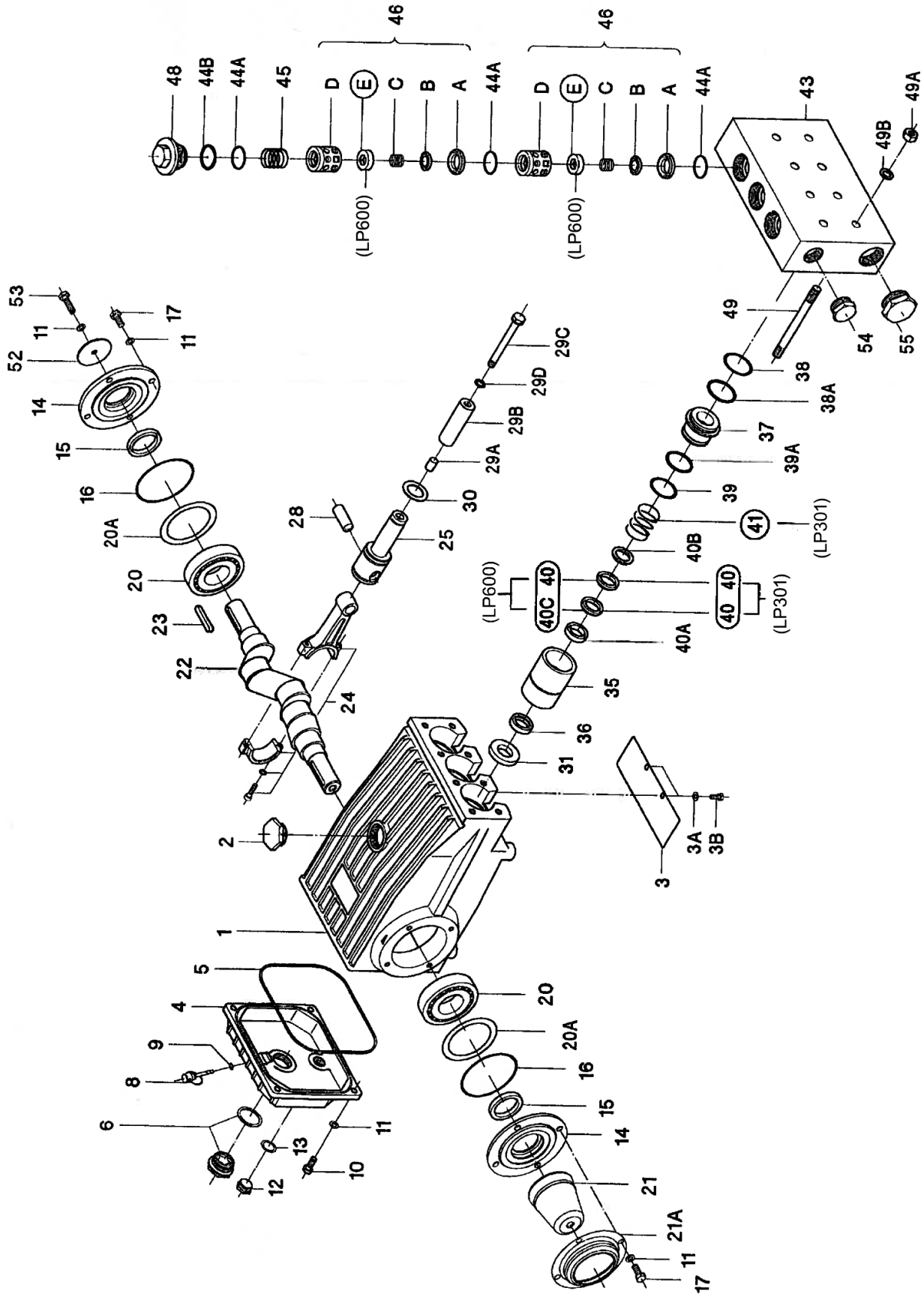

Parts List

LP301A/LP301A-4000/LP600/LP600-4000

ITEM	PART	DESCRIPTION	QTY	ITEM	PART	DESCRIPTION	QTY
1	07759	Crankcase	1	38	07140	O-Ring, Seal Case	3
2	13000	Oil Filler Plug Assy.	1	38A	13241	Support Ring for 38	3
3	05940	Cover Plate	1	39	13012	O-Ring (LP600/LP600-4000)	3
3A	07223-0100	Spring Ring	2	39	12055	O-Ring (LP301A/LP301A-4000)	3
3B	05051	Hexagon Screw	2	39A	13036	Support Ring for 39 (LP600/LP600-4000)	3
4	06085	Crankcase Cover	1	39A	07693	Support Ring for 39 (LP301A/LP301A-4000)	3
5	07104	O-ring, Crankcase Cover	1	40	07322	V-Sleeve (LP600/LP600-4000)	3
6	05943	Oil Sight Glass w/Gasket	1	40	06083	V-Sleeve (LP301A/LP301A-4000)	6
8	06086	Oil Dipstick Assy.	1	40A	07268	Pressure Ring (LP600)	3
9	01009	O-Ring, (For Dipstick)	1	40A	07268-0100	Pressure Ring, 316 S.S. (LP600-4000)	3
10	01010	Cylinder Screw (LP600/LP301A)	4	40A	13366	Pressure Ring (LP301A)	3
10	01010-0100	Cylinder Screw, 316 S.S. (LP600-4000/LP301A-4000)	4	40A	13366-0100	Pressure Ring, 316 S.S. (LP301A-4000)	3
11	01011-0400	Spring Ring (LP600/LP301A)	5	40B	07270	Support Ring for 40 (LP600)	3
11	01011-0100	Spring Ring, 316 S.S. (LP600-4000/LP301A-4000)	5	40B	07270-0100	Support Ring for 40, 316 S.S. (LP600-4000)	3
12	07109	Plug, G1/2" (LP600/LP301A)	1	40B	13367	Guide Ring for 40 (LP301A)	3
12	07109-0400	Plug, G1/2", 316 S.S. (LP600-4000/LP301A-4000)	1	40B	13438	Guide Ring for 40, 316 S.S. (LP301A-4000)	3
13	07182	Gasket	1	40C	05963	Sleeve (LP600/LP600-4000)	3
14	07111	Bearing Cover	2	41	07338	Pressure Spring (LP301A/LP301A-4000 Only)	3
15	07112	Radial Shaft Seal	2	43	13040	Valve Casing	1
16	07113	O-Ring for Bearing Cover	2	44A	07150	O-Ring	9
17	07114	Hexagon Screw (LP600/LP301A)	8	44B	06266	Support Ring for O-Ring	3
17	07114-0100	Hexagon Screw, 316 S.S. (LP600-4000/LP301A-4000)	8	45	06078	Compression Spring	3
20	07116	Taper Roller Bearing	2	46	08286	Valve Assy., Complete (LP600/LP600-4000)	6
20A	07117	Fitting Disc	1-3	46	07060	Valve Assy., Complete (LP301A/LP301A-4000)	6
20B	13001	Fitting Disc	1-3	46A	07064	Valve Seat (LP301A/LP301A-4000)	6
21	05376	Shaft Protector	1	46A	07064-0100	Valve Seat (LP600/LP600-4000)	6
21A	05377	Shaft Guard Holder	1	46B	13130	Valve Plate (LP600/LP600-4000)	6
22	13242	Crankshaft	1	46B	07063	Valve Plate (LP301A/LP301A-4000)	6
23	13243	Key	1	46C	07062-0100	Valve Spring	6
24	13340	Connecting Rod Assy.	3	46D	07066	Spacer Pipe (LP301A/LP301A-4000)	6
24A	13277	Inner Hex Screw	6	46D	05472	Spacer Pipe (LP600/LP600-4000)	6
24B	13278	Spring Washer	6	46E	05473	Valve Spring Guide (LP600/LP600-4000)	6
25	13341	Crosshead Assy.	3	48	06077	Plug	3
28	13232	Crosshead Pin	3	49	07157	Stud bolt	8
29A	07125	Centering Sleeve	3	49A	07158	Hexagon Nut	8
29B	07126	Plunger Pipe (LP600/LP600-4000)	3	49B	07159	Disc	8
29B	07127	Plunger Pipe (LP301A/LP301A-4000)	3	50	12250	Plug, G-1/2", S.S. (LP301A/LP301A-4000 Only)	1
29C	13031	Tensioning Screw	3	50A	06807	Steel Ring	1
29D	07755	Copper Ring (LP600/LP301A)	3	52	13020	Disc for Crankshaft	1
29D	07161-0100	Crush Washer (LP600-4000/LP301A-4000)	3	53	06607	Hexagon Screw	1
30	07779	Oil Scraper	3	54	13044*	Plug, G 1"	2
31	07133	Oil Seal	3	55	13151*	Plug, G 1-1/4"	2
35	13235	Seal Sleeve (LP600/LP600-4000)	3				
35	13364	Seal Sleeve (LP301A/LP301A-4000)	3				
36	13237	Leakage Seal (LP600/LP600-4000)	3				
36	13238	Leakage Seal (LP301A/LP301A-4000)	3				
37	13239	Seal Case (LP600/LP600-4000)	3				
37	13240	Seal Case (LP301A/LP301A-4000)	3				

*BSP to NPT Adapters/Seals (sold separately)
 Inlet Port = 13377 (Adapter) / 13376 (Seal)
 Discharge Port = 13373+ (Adapter) / 13372 (Seal)

* rated up to 3000 PSI. For higher pressure adapters, contact Giant.

Repair Kits

LP301A/LP301A-4000/LP600/LP600-4000

Plunger Packing Kits

LP301A - # 09459

For pumps manufactured on or after 4/96

<u>Item</u>	<u>Part #</u>	<u>Description</u>	<u>Qty.</u>
36	13238	Leakage Seal	3
38	07140	O-Ring	3
38A	13241	Support Ring	3
39	12055	O-Ring	3
39A	07693	Support Ring	3
40	06083	V-Sleeve	6
40A	13366	Pressure Ring	3

LP301A-4000 - # 09459-4000

<u>Item</u>	<u>Part #</u>	<u>Description</u>	<u>Qty.</u>
36	13238	Leakage Seal	3
38	07140	O-Ring	3
38A	13241	Support Ring	3
39	12055	O-Ring	3
39A	07693	Support Ring	3
40	06083	V-Sleeve	6
40A	13366-0100	Pressure Ring	3

LP600 - # 09197

<u>Item</u>	<u>Part #</u>	<u>Description</u>	<u>Qty.</u>
36	13237	Leakage Seal	3
38	07140	O-Ring	3
38A	13241	Support Ring	3
39	13012	O-Ring	3
39A	13036	Support Ring	3
40	07322	V-Sleeve	3
40A	07268	Pressure Ring	3
40C	05963	Sleeve	3

LP600-4000 - # 09197-4000

<u>Item</u>	<u>Part #</u>	<u>Description</u>	<u>Qty.</u>
36	13237	Leakage Seal	3
38	07140	O-Ring	3
38A	13241	Support Ring	3
39	13012	O-Ring	3
39A	13036	Support Ring	3
40	07322	V-Sleeve	3
40A	07268-0100	Pressure Ring	3
40C	05963	Sleeve	3

Valve Kits

LP301A/LP301A-4000 - # 09196

<u>Item</u>	<u>Part #</u>	<u>Description</u>	<u>Qty.</u>
44A	07150	O-Ring	6
44B	06266	Support Ring	3
46A	07064	Valve Seat	3
46B	07063	Valve Plate	3
46C	07062-0100	Valve Spring	3

LP301A/LP301A-4000 - # 09196A

<u>Item</u>	<u>Part #</u>	<u>Description</u>	<u>Qty.</u>
44A	07150	O-Ring	9
44B	06266	Support Ring	3
46A	07064	Valve Seat	6
46B	07063	Valve Plate	6
46C	07062-0100	Valve Spring	6

LP600/LP600-4000 - # 09195

<u>Item</u>	<u>Part #</u>	<u>Description</u>	<u>Qty.</u>
44A	07150	O-Ring	6
44B	06266	Support Ring	3
46A	07064	Valve Seat	3
46B	13130	Valve Plate	3
46C	07062-0100	Valve Spring	3

LP600/LP600-4000 - # 09195A

<u>Item</u>	<u>Part #</u>	<u>Description</u>	<u>Qty.</u>
44A	07150	O-Ring	9
44B	06266	Support Ring	3
46A	07064-0100	Valve Seat	6
46B	13130	Valve Plate	6
46C	07062-0100	Valve Spring	6

Oil Seal Kit - # 09577

<u>Item</u>	<u>Part #</u>	<u>Description</u>	<u>Qty.</u>
31	07133	Oil Seal	3

REPAIR INSTRUCTIONS - LP301A/LP301A-4000/LP600/LP600-4000

NOTE: Always take time to lubricate all metal and non-metal parts with a light film of oil before reassembling. This step will help ensure proper fit, at the same time protecting the pump non-metal parts (elastomers) from cutting and scoring.

TO CHECK VALVES

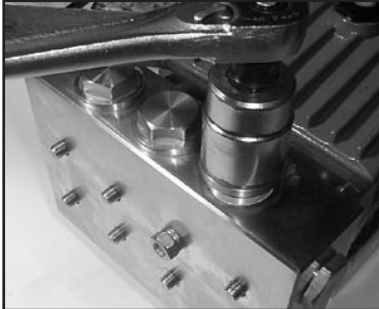

- 1) Loosen and remove tension plugs (48) with a 36mm socket wrench.



- 2) Remove the support ring (44B), O-ring (44A) and tension spring (45).



- 3) Take out discharge valve assemblies (46) by pulling them upwards out of the valve casing (43) with a snap-ring tongs or any other pull-off device. Then remove inlet valves in the same way.

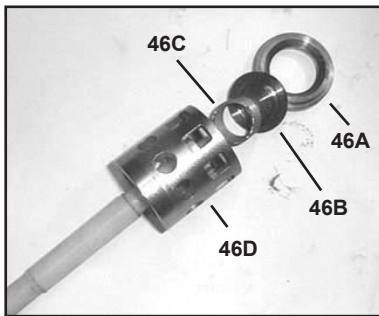

- 4) Loosen valve seats (46A) and valve spring (46C) from spacer pipe (46D) by lightly hitting the valve plate (46B) with a plastic stick. LP600/LP600-4000 pumps have an additional valve spring guide (46E). Check sealing surface and replace worn parts. Reassemble with new O-rings (44A) if possible and oil them before installing.

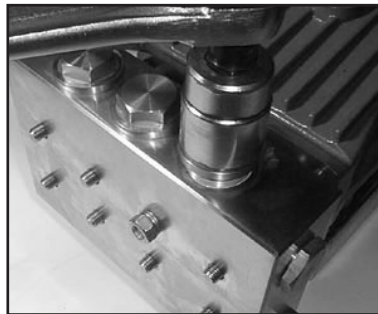

- 5) Tighten up tension plugs (48) to 107 ft.-lbs. (125 NM)

REPAIR INSTRUCTIONS - LP301A/LP301A-4000/LP600/LP600-4000

NOTE: Always take time to lubricate all metal and non-metal parts with a light film of oil before reassembling. This step will help ensure proper fit, at the same time protecting the pump non-metal parts (elastomers) from cutting and scoring.

TO CHECK SEALS AND PLUNGER PIPE

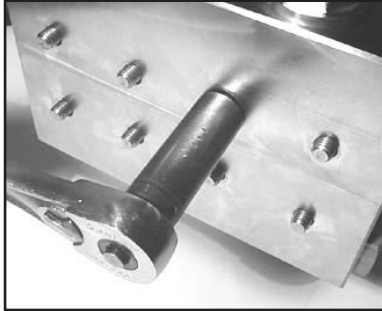

6) Loosen the 8 nuts (49A) with a 19mm socket and pull off valve casing (43) to the front.



7) Remove the seal sleeve (35) from the manifold and /or crankcase.

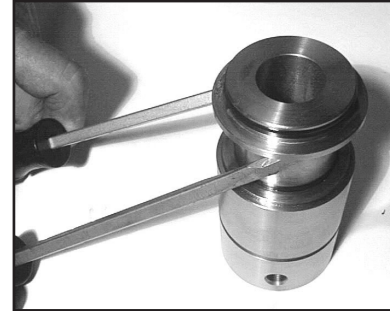

8) Remove seal case (37) from seal sleeve (35).

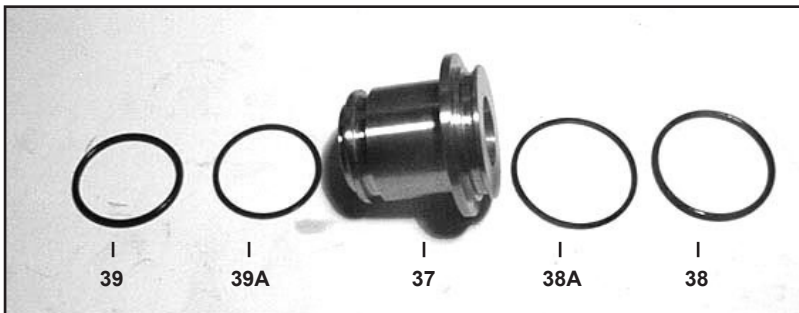

9) Check O-rings (39 & 38) and support rings (39A & 38A) on seal case (37).



10) Remove leakage seal (36) from the seal sleeve. If worn or damaged replace with new seal.

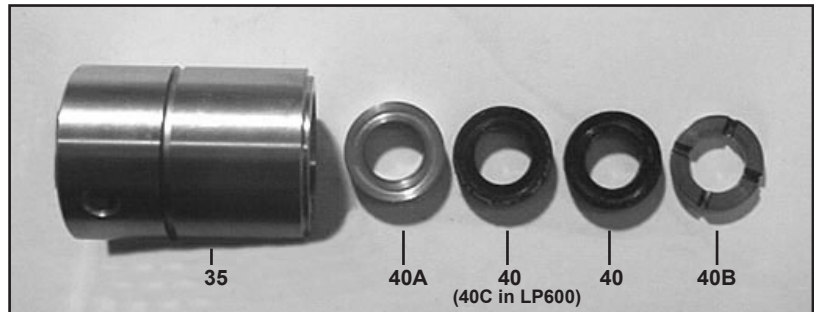

11) Remove the pressure ring (40A), v-sleeves (40), sleeve (40C in LP600 only), and support ring (40B), from the seal sleeve. For LP301A and LP301A-4000 pumps, remove the pressure spring (41). Examine seals carefully and replace if worn. Clean surfaces of seal sleeves (35) which come in contact with the crankcase (1) and sealing surfaces of valve casing (43).

REPAIR INSTRUCTIONS - LP301A/LP301A-4000/LP600/LP600-4000

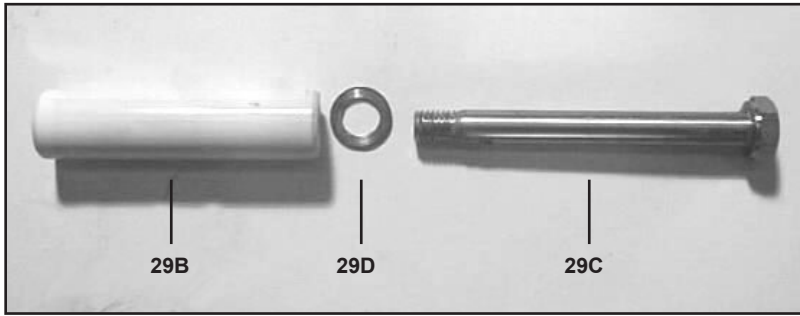

12) Check plunger surface (29B). If plunger pipe is worn out, loosen tension screws (29C) with a 15mm socket and pull off plunger pipe to the front. Clean front surface of plunger (29B) thoroughly. Apply a small drop of locktite to tension screw. Put a **new** crush washer (29D) onto tension screw. Put a thin coat of glue (Loctite) on the ring (or ceramic plunger side) and tighten screw to 265 in.-lbs. (30 NM).

13) Replace complete seal sleeve (35)/seal case (37) assembly into crankcase (1). Make sure that the weep hole points downward. **Note: To replace the oil seals (31), you will need to disassemble the gear end (see instructions below).**

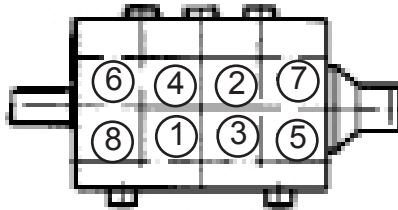
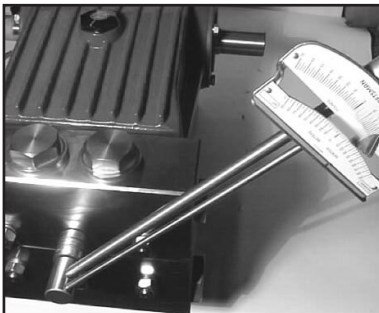

14) Place entire manifold/seal sleeve assembly over the studs and push firmly until seated against the crankcase.

15) Tighten hex nuts (49A) in a crosswise pattern (shown above) to 59 ft.-lbs.

REPAIR INSTRUCTIONS - LP301A/LP301A-4000/LP600/LP600-4000

TO DISMANTLE GEAR END

After removing valve casing (43) and plunger pipe (29B), drain the oil. Remove the gear cover (4) and both bearing covers (14). Loosen connecting rod screws (24A) and push the front of the connecting rod (24) forward as far as possible into the crosshead guide.

IMPORTANT! Connecting rods (24) are marked for identification. Do not twist connecting rod halves. Connecting rod is to be reinstalled in the same position on shaft journals.

Turning the crankshaft (22) slightly, hit it out carefully to the side with a rubber hammer.

IMPORTANT! Do not bend the connecting rod (24) shanks. Check crankshaft (22) and connecting rod (24) surfaces, radial shaft seals (15) and taper roller bearings (20).

To remove the oil seals (31) use a wooden rod and sharply hit down on the oil seals from the crankcase (1). Note: when replacing the oil seals, apply a small amount of locktight to the outside edges of each oil seal before re-inserting them into the crankcase.

To Reassemble

Using a soft tool, press in the outer bearing ring until the outer edge lines up with the outer edge of the bearing hole. Remove bearing cover (14) together with radial shaft seal (15) and o-ring (16). Fit crankshaft (22) through bearing hole on the opposite side. Press in outer bearing and tighten it inwards with the bearing cover, keeping the crankshaft in vertical position and turning slowly so that the taper rollers of the bearings touch the edge of the outer bearing ring. Adjust axial bearing clearance to at least 0.1mm and maximum 0.15mm by placing fitting discs (20A and 20B) under the bearing cover.

IMPORTANT! After assembly has been completed, the crankshaft should turn easily with very little clearance. Tighten connecting rod screws (24A) to 310 in.-lbs. Re-assemble the fluid end (see instructions above).

LP301A/LP301A-4000/LP600/LP600-4000 TORQUE SPECIFICATIONS			
<u>Position</u>	<u>Item#</u>	<u>Description</u>	<u>Torque Amount</u>
6	05943	Oil Sight Glass w/Gasket	354 in.-lbs. (40 NM)
10	01010/01010-0100	Cylinder Screw	221 in.-lbs. (25 NM)
12	07109	Plug, 1/2" BSP	354 in.-lbs. (40 NM)
17	07114/07114-0100	Hexagon Screw	221 in.-lbs. (25 NM)
24A	13277 (LP301A)	Inner Hex Screw, Connecting Rod	310 in.-lbs. (35 NM)
24A	13277 (LP600)	Inner Hex Screw, Connecting Rod	265 in.-lbs. (30 NM)
29C	13031	Tension Screw, Plunger	265 in.-lbs. (30 NM)
48	06077	Plug, Discharge	107 ft.-lbs. (145 NM)
49A	07158	Hexagon Nut, Stud Bolts	59 ft.-lbs. (80 NM)

Pump Mounting Selection Guide

Bushings

06496 - 35 mm H Bushing

Pulley & Sheaves

07165 - 12.75" Cast Iron - 4 gr.
AB Section

Rails

07357 - Plated Steel Channel Rails
(L=11.75"x W=1.88"x H=3.00")

Pump System Malfunction

<u>MALFUNCTION</u>	<u>CAUSE</u>	<u>REMEDY</u>
The Pressure and/or the Delivery Drops	Worn packing seals Broken valve spring Belt slippage Worn or Damaged nozzle Fouled discharge valve Fouled inlet strainer Worn or Damaged hose Worn or Plugged relief valve on pump Cavitation Unloader	Replace packing seals Replace spring Tighten or Replace belt Replace nozzle Clean valve assembly Clean strainer Repair/Replace hose Clean, Reset, and Replace worn parts Check suction lines on inlet of pump for restrictions Check for proper operation
Water in crankcase	High humidity Worn seals	Reduce oil change interval Replace seals
Noisy Operation	Worn bearings Cavitation	Replace bearings, Refill crankcase oil with recommended lubricant Check inlet lines for restrictions and/or proper sizing
Rough/Pulsating Operation with Pressure Drop	Worn packing Inlet restriction Accumulator pressure Unloader Cavitation	Replace packing Check system for stoppage, air leaks, correctly sized inlet plumbing to pump Recharge/Replace accumulator Check for proper operation Check inlet lines for restrictions and/or proper size
Pressure Drop at Gun	Restricted discharge plumbing	Re-size discharge plumbing to flow rate of pump
Excessive Leakage	Worn plungers Worn packing/seals Excessive vacuum Cracked plungers Inlet pressure too high	Replace plungers Adjust or Replace packing seals Reduce suction vacuum Replace plungers Reduce inlet pressure
High Crankcase Temperature	Wrong Grade of oil Improper amount of oil in crankcase	Giant oil is recommended Adjust oil level to proper amount

Preventative Maintenance Check List & Recommended Spare Parts List						
Check	Daily	Weekly	50 hrs	Every 500 hrs	Every 1500 hrs	Every 3000 hrs
Oil Level/Quality	X					
Oil Leaks	X					
Water Leaks	X					
Belts, Pulley		X				
Plumbing		X				
Recommended Spare Parts						
Oil Change (1 Gallon) p/n 01154			X	X		
Oil Seal Kit (1 kit/pump) (see page 6 for kit list)					X	
Seal Spare Parts (1 kit/pump) (see page 6 for kit list)					X	
Valve Spare Parts (1 kit/pump) (see page 6 for kit list)						X

Dimensions (mm) - LP301A/LP301A-4000/LP600/LP600-4000

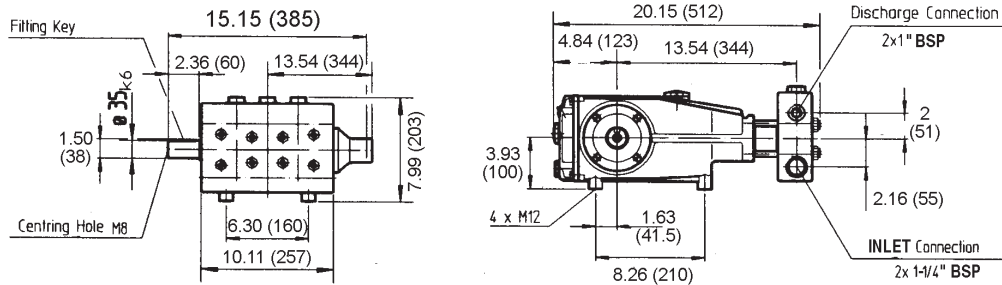

GIANT INDUSTRIES LIMITED WARRANTY

Giant Industries, Inc. pumps and accessories are warranted by the manufacturer to be free from defects in workmanship and material as follows:

1. For portable pressure washers and car wash applications, the discharge manifolds will never fail, period. If they ever fail, we will replace them free of charge. Our other pump parts, used in portable pressure washers and in car wash applications, are warranted for five years from the date of shipment for all pumps used in NON-SALINE, clean water applications.
2. One (1) year from the date of shipment for all other Giant industrial and consumer pumps.
3. Six (6) months from the date of shipment for all rebuilt pumps.
4. Ninety (90) days from the date of shipment for all Giant accessories.

This warranty is limited to repair or replacement of pumps and accessories of which the manufacturer's evaluation shows were defective at the time of shipment by the manufacturer. The following items are NOT covered or will void the warranty:

1. Defects caused by negligence or fault of the buyer or third party.
2. Normal wear and tear to standard wear parts.
3. Use of repair parts other than those manufactured or authorized by Giant.
4. Improper use of the product as a component part.
5. Changes or modifications made by the customer or third party.
6. The operation of pumps and or accessories exceeding the specifications set forth in the Operations Manuals provided by Giant Industries, Inc.

Liability under this warranty is on all non-wear parts and limited to the replacement or repair of those products returned freight prepaid to Giant Industries which are deemed to be defective due to workmanship or failure of material. A Returned Goods Authorization (R.G.A.) number and completed warranty evaluation form is required prior to the return to Giant Industries of all products under warranty consideration. Call (419)-531-4600 or fax (419)-531-6836 to obtain an R.G.A. number.

Repair or replacement of defective products as provided is the sole and exclusive remedy provided hereunder and the MANUFACTURER SHALL NOT BE LIABLE FOR FURTHER LOSS, DAMAGES, OR EXPENSES, INCLUDING INCIDENTAL AND CONSEQUENTIAL DAMAGES DIRECTLY OR INDIRECTLY ARISING FROM THE SALE OR USE OF THIS PRODUCT.

THE LIMITED WARRANTY SET FORTH HEREIN IS IN LIEU OF ALL OTHER WARRANTIES OR REPRESENTATION, EXPRESS OR IMPLIED, INCLUDING WITHOUT LIMITATION ANY WARRANTIES OR MERCHANTABILITY OR FITNESS FOR A PARTICULAR PURPOSE AND ALL SUCH WARRANTIES ARE HEREBY DISCLAIMED AND EXCLUDED BY THE MANUFACTURER.

GIANT

Performance Under Pressure

GIANT INDUSTRIES, INC., 900 N. Westwood Ave., P.O. Box 3187, Toledo, Ohio 43607
PHONE (419) 531-4600, FAX (419) 531-6836, www.giantpumps.com
© Copyright 2013 Giant Industries, Inc.