

Part #	Description	2012/2013 Sug. Retail
CPS165-BQN	Sprayer Turbo Body	25.00
CPF250-BE	Floater Nozzle Body	36.50
CPF250-HV	Floater Nozzle Body—High Vol	38.20
CPF256T	Turbo Tip Washer	.68
CPF256THV	Turbo Tip Washer, High Volume	.72
CPF281T-L	Turbo Poly Selector, Low Volume	15.80
CPF281HVF	Turbo Poly Selector, High Volume	15.96
CPS166	Clip for Sprayer Turbo	1.90
CPS281T	Sprayer Turbo Selector Stand. Vol.	11.80
CPS281T-L	Sprayer Turbo Selector—Low Vol	11.80
CPS281T-H	Sprayer Turbo Selector—High Vol	11.80
CPF285T	Turbo Tip Wheel	15.80
CPF285HVT	Turbo Tip Wheel, High Volume	15.96
CPS285T	Sprayer Turbo Tip Wheel	11.80
CPF286E	Teflon Seal—E-Version	1.36
CPF286HV	Teflon Seal—High Volume	1.40
CPS286	Sprayer Turbo Teflon Seal	1.60
CPF289	Teflon Washer	.60
CP318-8	#8 O-Ring Viton [®]	.55
CP318-10	#10 O-Ring, Viton [®]	.56
CP318-11	#11 O-Ring, Viton [®]	.57
CP318-13	#13 O-Ring, Viton [®]	.60
CP318-14	#14 O-Ring, Viton [®]	.60
CP363	Gasket, 3/4" EPDM	1.26
CP364	Gasket, 1/2" EPDM	1.26

Part #	Description	2012/2013 Sug. Retail
CP365	Gasket, 3/16" EPDM	2.00
CP376	Detent Spring, Stainless Steel	.68
CP377	Detent Ball, 5/32", 316SS	.77
CP387	Stainless Steel Locking Nut	.90
CP388	Stainless Steel Washer	.35
CPF270-5	Floater Turbo Tip—5 (Special Order)	39.00
CPF270T-7.5	Floater Turbo Tip—7.5	34.80
CPF270T-10	Floater Turbo Tip-10 (Special Order)	39.00
CPF270T-12	Floater Turbo Tip—12	35.80
CPF270T-15	Floater Turbo Tip—15 (Special Order)	39.00
CPF270T-18	Floater Turbo Tip—18	35.80
CPF270T-30	Floater Turbo Tip-30 (Special Order)	39.00
CPF270T-35	Floater Turbo Tip—35	36.00
CPF270T-60	Floater Turbo Tip-60 (Special Order)	39.00
CPF270T-60HV	Floater Turbo Tip-60HV	45.00
CPS275T-2	Poly Sprayer Turbo Tip—2	6.50
CPS275T-3	Poly Sprayer Turbo Tip—3	6.50
CPS275T-4	Poly Sprayer Turbo Tip—4	6.50
CPS275T-6	Poly Sprayer Turbo Tip—6	6.50
CPS275T-7.5	Poly Sprayer Turbo Tip—7.5	6.50
CPS275T-10	Poly Sprayer Turbo Tip—10	6.50
CPS275T-15P	Poly Sprayer Turbo Tip-15	6.50
CPS275T-25P	Poly Sprayer Turbo Tip—25	6.50
CPS275T-33P	Poly sprayer Turbo Tip—33	6.50
CPS275T-3SS	Poly Sprayer Turbo Triple-Stream Accessory Tip	10.00

Prices effective 11/01/12 and are subject to change without notice.

Note: CP has a limited parts inventory for discontinued nozzles. If the part needed is not listed here, call CP toll free 1 866 303-0600.

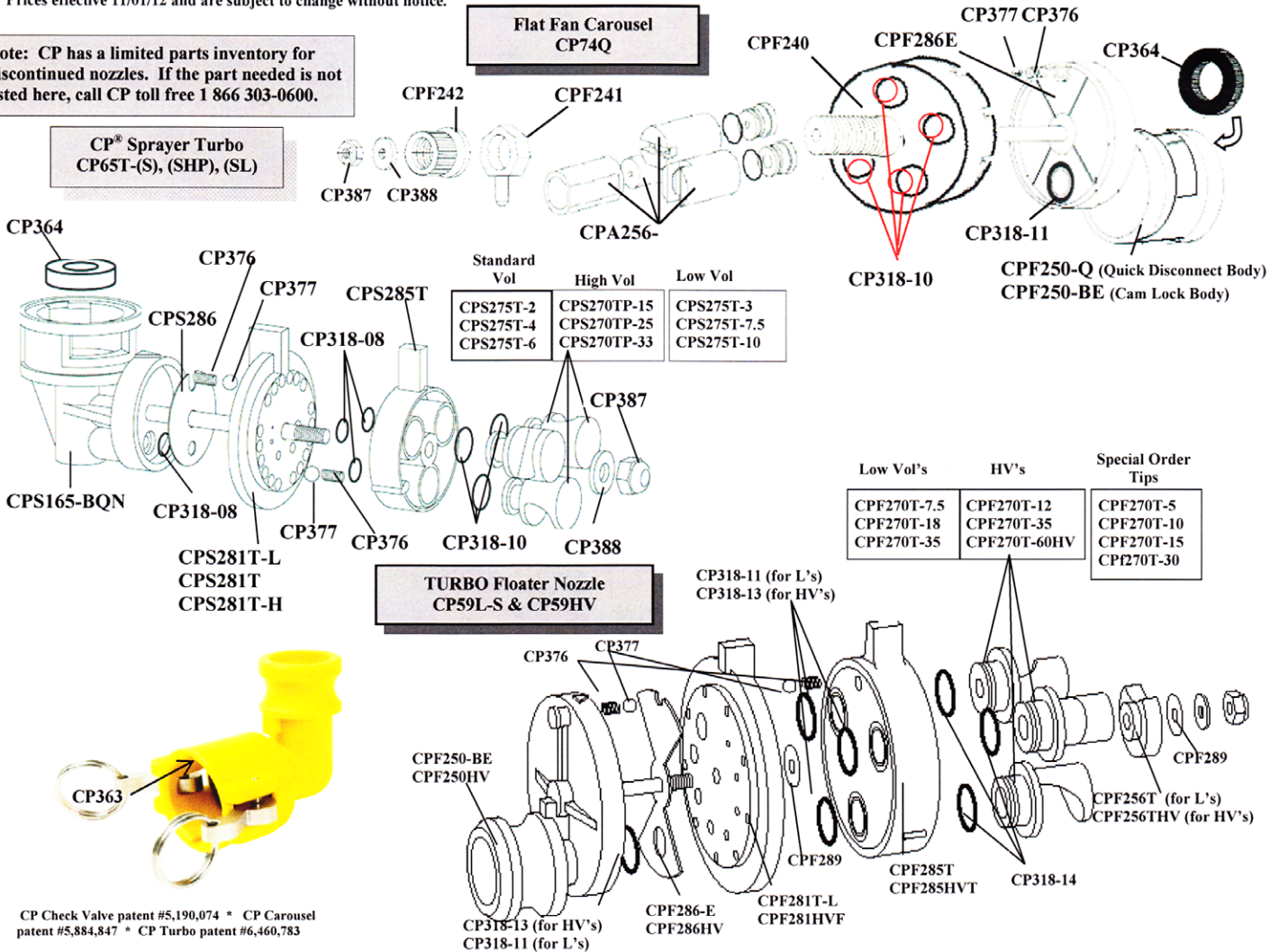

CP® Check Valve and Combo Parts
(Illustrations not to scale)

CP Split Eye Check Valve
CP112SE 3/4, CP112SE1

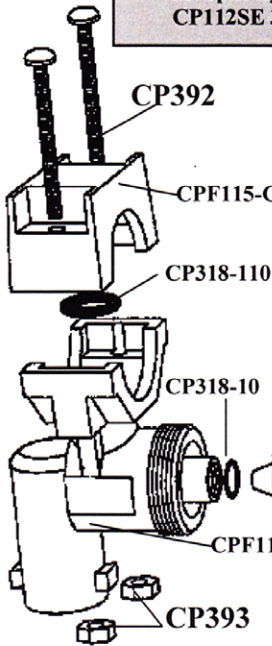

Assembled Split Eye Poppet
CP212-A

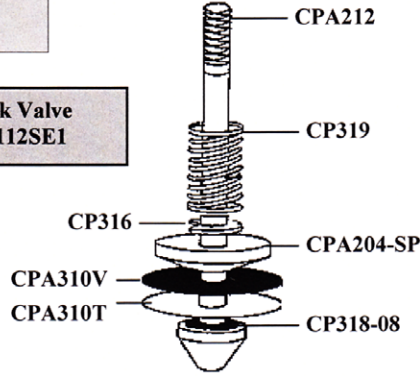

CP212-A Assembled Aerial Poppet

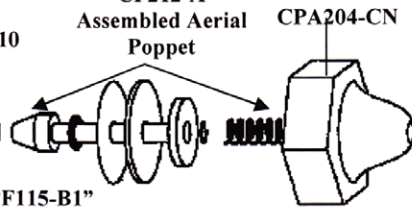

Assembled Ground Poppet
CP212-F

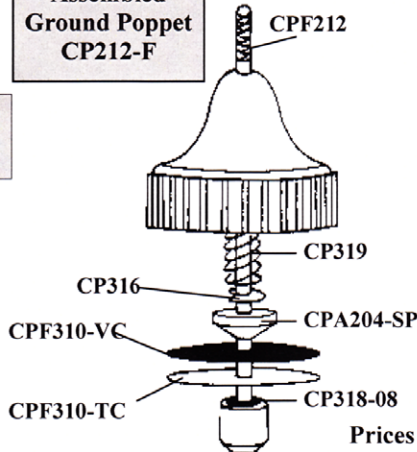

CP® Floater Check Valve
CP110-C & CP110-P

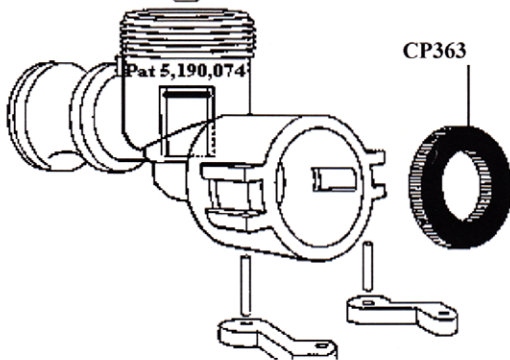
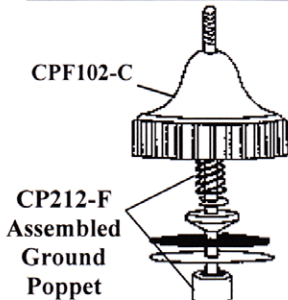

Part #	Description	2012/2013 Sug. Ret.
CPF102-B	Combo Body	82.80
CPF102HV	High Volume Turbo Combo Body	82.80
CPF102-C	Check Valve/Combo Cap	10.20
CPA204-CN	Nylon Split Eyelet Check Valve Cap	9.80
CPA204-SP	Poly Seal Plate	3.50
CPF212	Ground Poppet Stem ONLY	23.00
CPA212	Aerial Poppet Stem ONLY	23.00
CP212-A	Assembled Split Eye Poppet	25.40
CP212-F	Assembled Ground Poppet	27.40
CPF256T	Turbo Tip Washer	.68
CPF256THV	High Volume Turbo Tip Washer	.72
CPF270T-5	Floater Turbo Tip-5 (Special Order)	39.00
CPF270T-7.5	Floater Turbo Tip-7.5	34.80
CPF270T-10	Floater Turbo Tip-10 (Special Order)	39.00
CPF270T-12	Floater Turbo Tip-12	35.80
CPF270T-15	Floater Turbo Tip-15 (Special Order)	39.00
CPF270T-18	Floater Turbo Tip-18	35.80
CPF270T-30	Floater Turbo Tip-30 (Special Order)	39.00
CPF270T-35	Floater Turbo Tip-35	36.00
CPF270T-60	Floater Turbo Tip-60 (Special Order)	39.00
CPF270T-60HV	Floater Turbo Tip-60HV	45.00
CPF281T-L	Turbo Poly Selector, Low Volume	15.80
CPF281HVC	Turbo Poly Selector, High Volume	15.96
CPF285T	Turbo Tip Wheel	15.80
CPF285HVT	Turbo Tip Wheel, High Volume	15.96
CPF286E	Teflon Seal, E-Version	1.36
CPF286HV	Teflon Seal, High Volume	1.40
CPF289	Teflon Washer	.60
CPA310-T	Split Eyelet Teflon Seal	.74
CPA310-V	Split Eyelet Viton® Seal	1.30
CPF310-TC	Combo Teflon Diaphragm	1.20
CPF310-VC	Combo Viton® Diaphragm	1.36
CP316	Stainless Steel E-Ring	.55
CP318-08	#8 O-Ring, Viton®	.55
CP318-10	#10 O-Ring, Viton®	.56
CP318-11	#11 O-Ring, Viton®	.57
CP318-13	#13 O-Ring, Viton®	.60
CP318-14	#14 O-Ring, Viton®	.60
CP318-110	#110 O-Ring, Viton®	.52
CP319	Combo Stainless Steel Spring	.57
CPF320	Split Eyelet Spring	.56
CP363	Gasket, 3/4" EPDM	1.26
CP376	Detent Spring, Stainless Steel	.68
CP377	Detent Ball, Stainless Steel	.77
CP387	Stainless Steel Locking Nut	.90
CP388	Stainless Steel Washer	.35
CP390	#6 Pan Nut with Lock Washer	.28
CP391	#6 Pan Screw	.31
CP392	#8 Pan Screw	.31
CP393	#8 Pan Nut with Lock Washer	.33

Prices effective 11/01/12 and are subject to change without notice.

CP® Turbo Combo Nozzle
CP109L-S & CP109HV

- CPF270T-5
- CPF270T-10
- CPF270T-15
- CPF270T-30
- CPF270T-7.5
- CPF270T-18
- CPF270T-35
- CPF270T-12
- CPF270T-30
- CPF270T-60HV

Special Order Tips

Low Vol

High Vol

