

CONTINENTAL NH3 PRODUCTS

INSTALLATION, OPERATION, REPAIR AND MANTINANCE INSTRUCTIONS

PRODUCT SERIES: A-SF-3000BD

ATTENTION: Please follow all of the instruction in this manual carefully and read the entire manual completely, failure to do so may cause the product to function improperly or fail causing serious injury or death.



ANHYDROUS AMMONIA IS AN INHALATION HAZARD AND WILL CAUSE SERIES INJURY OR DEATH. PLEASE USE EXTREME CAUTION WHEN HANDLING IT OR PERFORMING ANY MAINTENANCE ON EQUIPMENT USED FOR ANHYDROUS AMMONIA.

ATTENTION: Before performing any installation, repair or maintenance please follow the instructions below.

1. You must be certified to work with anhydrous ammonia. If you are not please seek out the appropriate agricultural department to attend a class to obtain the proper certification.
2. Wear appropriate safety goggles, gloves and breathing apparatuses.
3. Drain all tanks, hoses and piping of anhydrous ammonia COMPLETELY before removing, installing, performing maintenance or repairing any equipment.
4. Always remove device from service before performing any maintenance or repair
5. have sufficient water near by
6. Obey all local, state and federal laws regarding the handling of anhydrous ammonia
7. ALL WAYS USE THREAD SEALANT ON ALL THREADS

INSTALLATION & OPERATION

1. The A-SF-3000BD is a duel heat exchanger and is designed to be used with electronic or ground driven pump systems. For additional assistance refer to Raven or Dickey-john for installation instructions on how it is to be hooked up to there equipment. For tool bar mounting and installation with Continental NH3's equipment see next step and the following pages for instructions.
2. Use the provided U-bolts to attach the 4 mounting brackets, SF-101-H, to the A-SF-3000BD as shown in the photo below, and tighten the nuts firmly. For convince they may be place anywhere along the length of the super flow so long as sufficient support is provided to stabilize the unit.

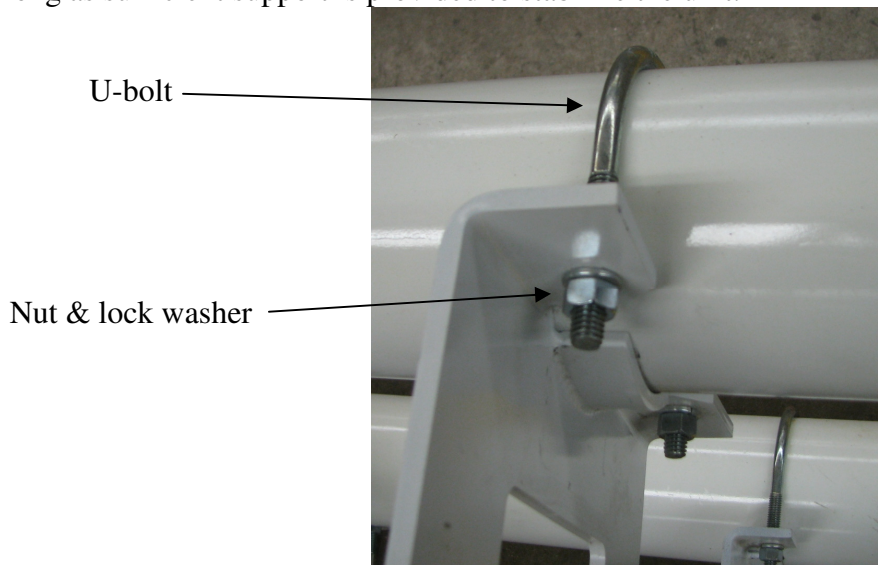

3. Place the unit onto the toolbar in a convenient but secure location and install the appropriate size U-bolts in the holes provided in the mounting bracket as shown in the photo below. You may also weld it to the tool bar if desired.

Predrilled holes for u-bolts

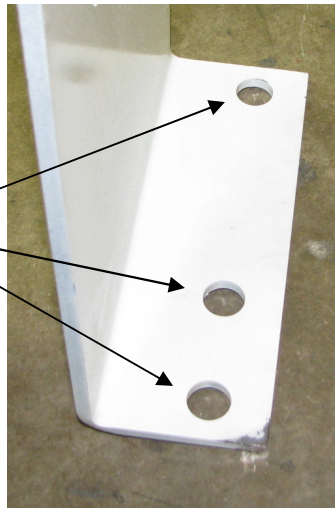

4. Please pay close attention to the inlets and outlet so when you install your supply hoses and controlling equipment they will pointing in the correct direction. See photo below.

Outlet

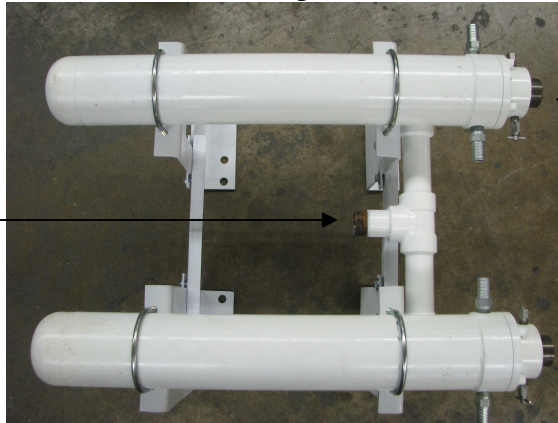

Inlets

5. Install all 4 of the 1/2" MPT X 3/4" hose, dump hose barb 7550 into the end of the SF-3000BD and tighten with appropriate wrench. Put thread sealant on the pipe threads prior to installation to prevent leaking. See photo below

Dump outlet hose barb 7550

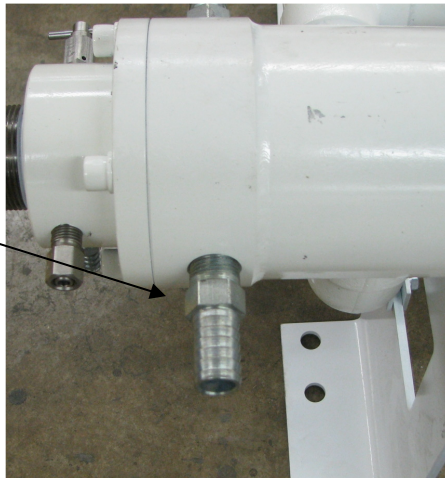

6. Weld all 4 of EQ-715 dump knives to the back of 4 applicator knives evenly spaced on the tool bar.
7. Attach appropriate length 3/4" nylon braided applicator hose from the 7550 hose barb to the EQ-715 and use worm gear clamps or equivalent to secure the hose the dump knife and hose barb.

8. Depending on your needs local requirements you will need to install a back check A-14BC for 1-1/4" lines or A-15BC for 1-1/2" supply lines as well as ball valves and Y-strainers to inlets of the heat exchanger. See photo below. The order in which to go is not critical but there are some considerations. If you put the ball valve directly on the heat exchanger you can shut them off and clean the y-strainer. This will help reduce the chance of ammonia burping back out of the heat exchanger.

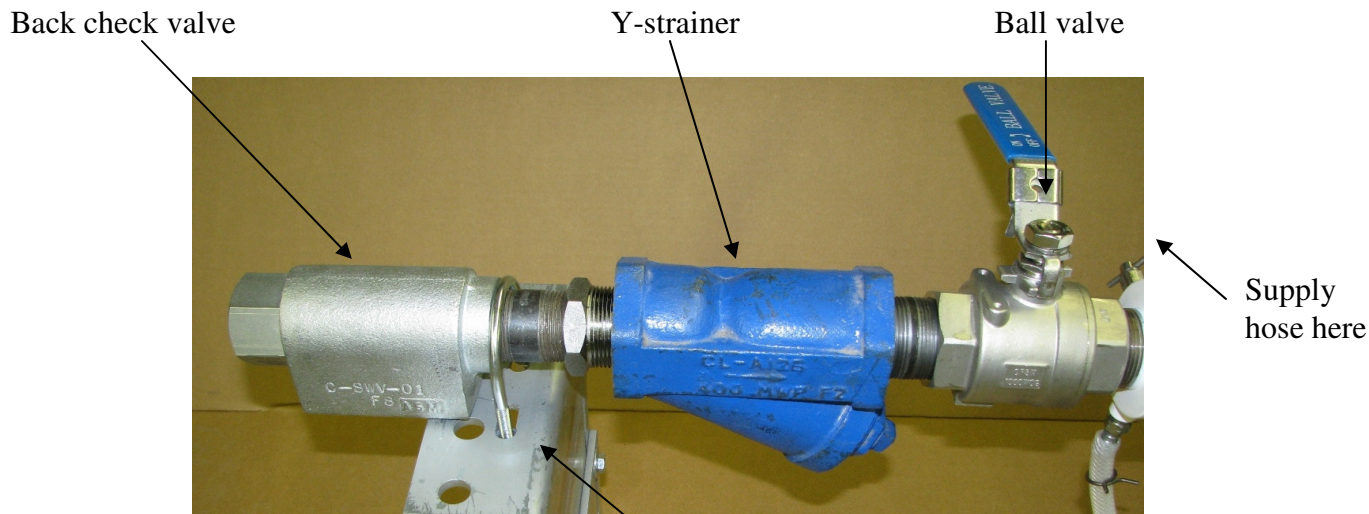

If additional support is desired purchase the A-CBKT. Not included in unit

NOTE: Depending on supply hose size you may need 1-1/4" or 1-1/2" nipples and bushings. The above picture is a representation of what it should look like. Please size the items correctly. If you have purchase a complete kit from Continental then it will come with the correct equipment and hardware.

NOTE: We when a back check is required we recommend supporting the above plumbing with a support bracket. Our part number is A-SF-CBKT, see illustration in step 14.

9. Install appropriate size anhydrous ammonia supply hose to heat exchanger unit as shown in step 8. Make sure to unions if necessary. Never use swivel adaptors, they are restrictive and on the supply side we never want to restrict flow.
10. Your next step will be to install the flow meter and controlling equipment on the outlet port of the super flow as illustrated in step 4. If you have another manufacturer equipment please refer to their installation instruction add install it as directed by them and skip to step # 13. If you are installing Continental's meter and controlling equipment proceed to the next step.
11. Install the flow meter MT-150-FLM, Control valve A-CVT-125-CT, shut off valve A-BVT-125-SO and accompanying nipples and bushings onto the outlet port of the super flow as shown in the photo below.

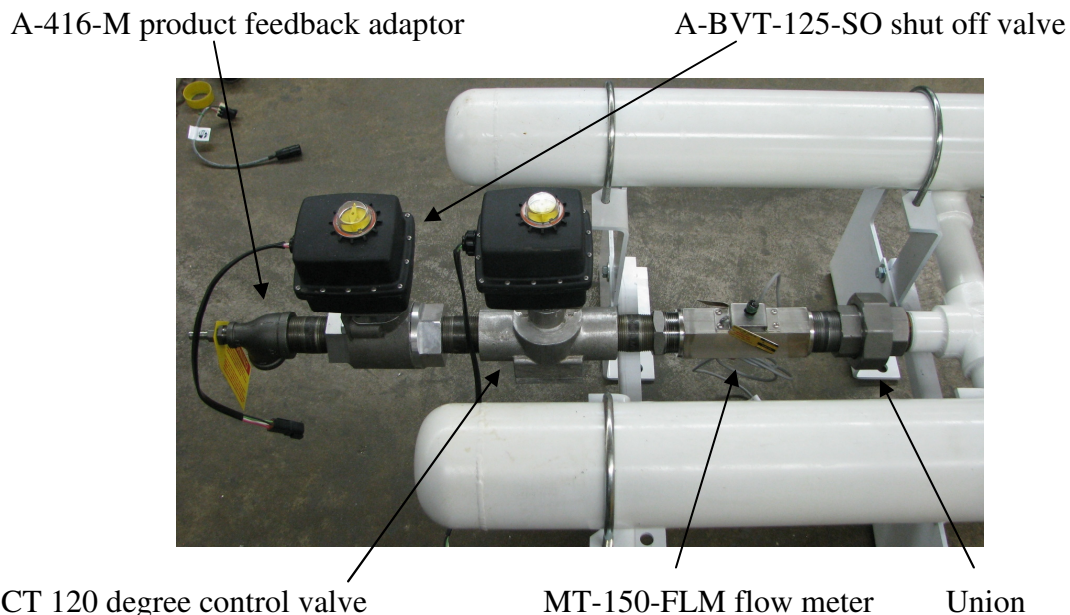

A-CVT-125-CT 120 degree control valve

MT-150-FLM flow meter

Union

12. For single shut off systems follow this step, for multiple shut off systems or boom style sectional shutoffs, please skip to step # 14. Install the feedback adaptor A-416-M onto the outlet port of the shut off valve A-BVT-125-SO **EXACTLY** as shown in the photo below. It must be install in this direction, if installed in the opposite direction then unit will not work properly. You do not have to use the A-416-M, you can use any tee you desire but it must be install in the direction shown in the photo below.

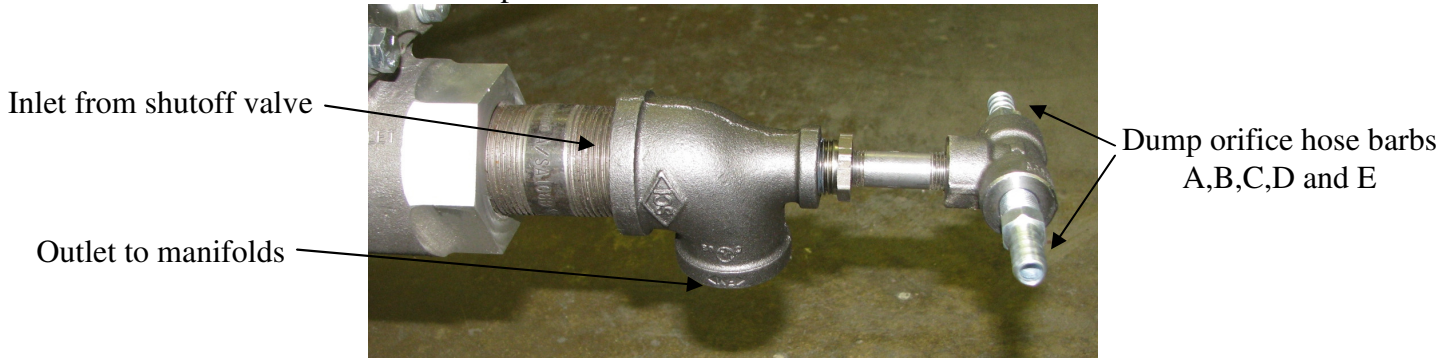

13. For multiple shut off systems or boom style shut off systems you must install a back check in the system to prevent the dump lines from venting. Follow step 13 and install the product feedback adaptor A-416-M. Then install the back check A-14BC onto the outlet side of the product feedback adaptor as shown in the photo below. Make sure you install a hydrostatic relief valve in one of the 1/4" ports in the back check. This must be done to protect the hose's downstream of the back check from bursting. **ANSI K61.1 REQUIRES THAT A RELIEF VALVE BE INSTALLED IN ANY SECTION OF PIPE OR HOSE THAT CAN TRAP AMMOINIA TO PROTECT IT FROM BURSTING.**

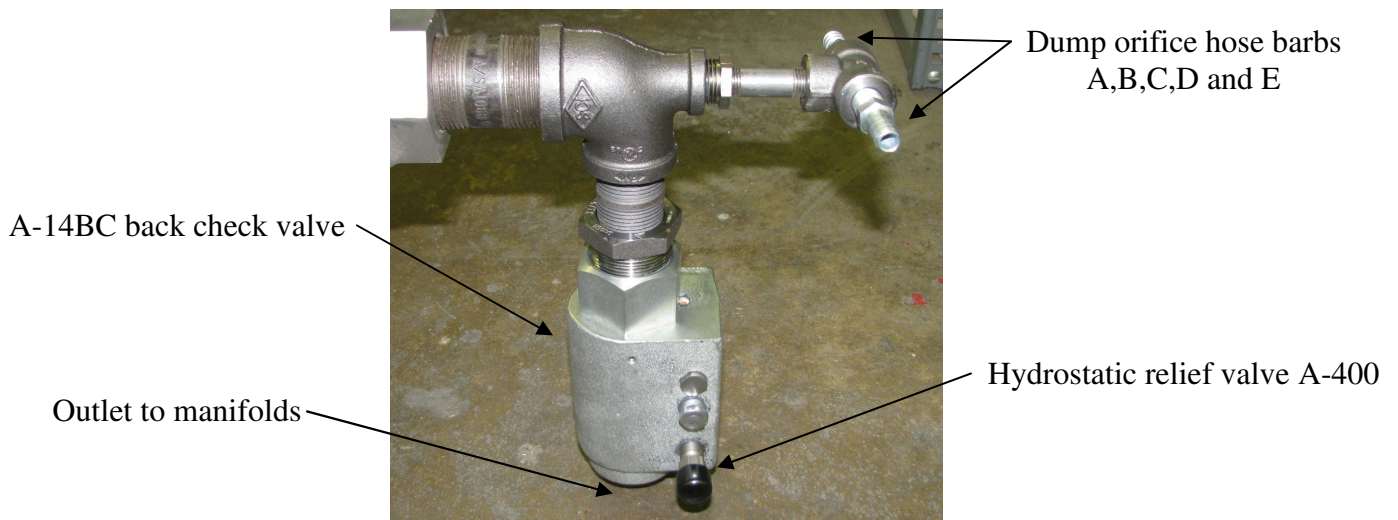

14. Adjust the outlet support bar so it supports the flow meter and controlling equipment as shown the photos below. If you need further support you use our adjustable C bracket support A-SF-CBKT. See picture below.

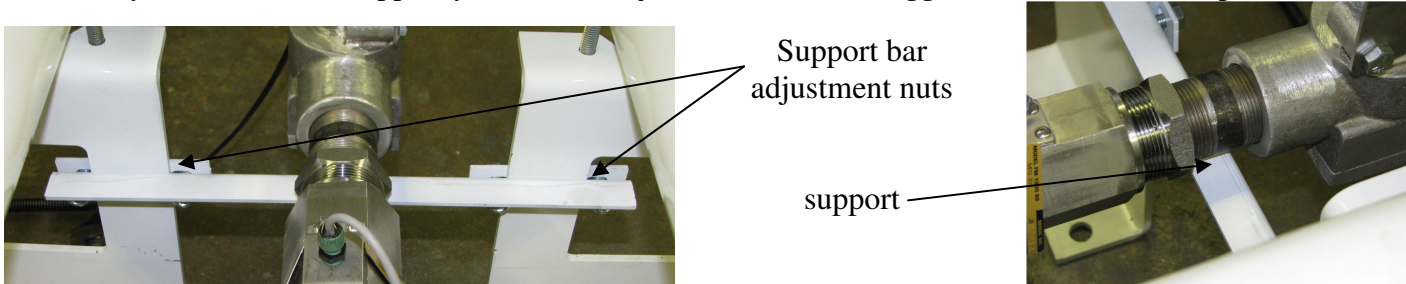

NOTE: future support brackets may look different than the above pictures.

15. Install the sectional or boom shut off valves A-BVT-1-SO on to the manifolds as desired. The locations of these valves are not critical. You can put them directly onto the manifolds or on the outlet side of the splitter or tee that goes to the manifolds.
16. The super flow is designed to use dump orifices to supply the heat exchanger with ammonia. **This is an option not a requirement.** If you are not concerned with the amount of ammonia going out the dump lines please install the letter “D” orifice hose into the tee as shown in the photos below.

Dump orifice hose barbs A, B, C, D and E are installed here

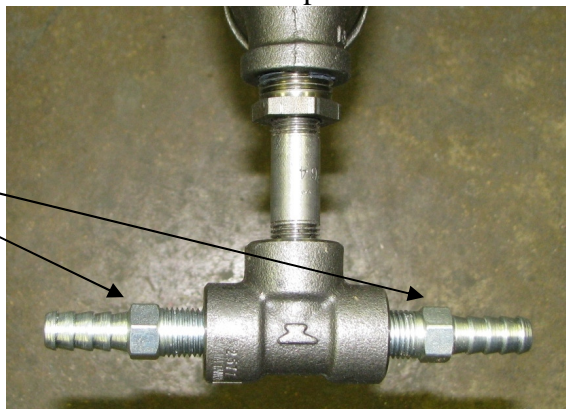

Note the stamp shown in the photo below.

Letter “D” stamped here

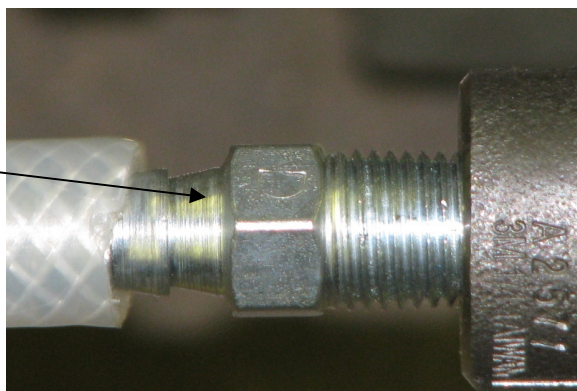

17. If you want to minimize the amount of ammonia going out the dump lines please follow the chart below to determine the dump orifice hose barb size to use and install it in the same manner as shown in step 18. The chart is based on GPM, gallons per minute. Use the formula below to determine your GPM then refer to the chart for the recommended dump orifice hose barb needed for your application.

Tool bar width in feet X speed X actual lbs N per acre X .1212 ÷ .82 ÷ 5.14 ÷ 60 = GPM

1-12 GPM	13-18 GPM	19-26 GPM	27-33 GPM	34 – UP GPM
A	B	C	D	E

NOTE: “E” orifice is only required for 1-1/2” supply hose plumbing. If you are running 1-1/4” supply hose do Not use “E”.

TIP: If you find that your rate doesn’t balance out try installing the next larger size orifice.

18. Attach the 3/8" applicator hose from the A-1132 hose barb located at the back of the SF-3000BD to the dump orifice hose bards located in the A-EQM-416 and secure it with the hose barb clips included with the unit as shown in the photos below.

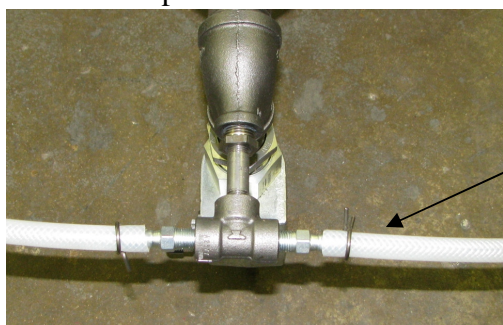

3/8" product feedback hose

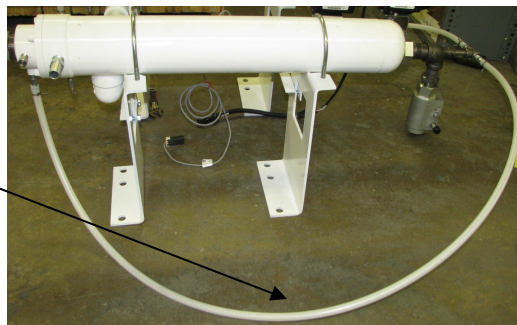

19. If functioning normal the A-SF-3000 should only dump ammonia out the dump knives when Applying ammonia down the field.

20. The "CAL" numbers used to control the electronics are as follows

	Raven	GS2	Tremble
1. MT-150-FM Flow meter			
2. A-CVT-125-CT standard Control valve	2223	2223	2223
Note: This is a standard control valve for 2 valve system			
3. A-BVT-125-CT Fast valve	0743	0743	0743
Note: This is a fast valve for a single valve system.			
4. A-BVT-125-SO Shut off valve	not req.	not req.	not req.

MAINTENANCE

1. Check unit regularly for leaks and wear.
2. Clean unit annually if possible and store it out of the weather. This will prolong the life of the heat exchanger as well as any other equipment you may have.
3. If leaking from a weld seam remove from service immediately and send it us for repair.
4. If leaking from a pipe thread connection try tightening the connection with a wrench, if this fails replace the unit or part that is leaking.
5. If leaking from the upper and lower body, or from the dump knives when not running install a repair kit or replace unit immediately..

REPAIR

1. Remove unit from service by following the above ATTENTIONS AND CAUTIONS.
2. Open bleeder both bleeder valves located at the bottom of the A-SF-3000 to help drain the system.
3. Remove 4 Allen screws 09-375-125 located at the bottom or end of the SF-3000 and pull the upper body off of the lower body and replace the 2 upper o-rings SF-B133 and the 1 lower o-ring SF-B235. Coat the o-rings with some grease to prevent them from being cut when you reassemble the too pieces.
4. Reassemble the upper and the lower body and screw the 4 Allen screws back into the SF-3000 and tighten firmly with Allen wrench.
5. Reinstall unit back into service by following the installation instruction above.

QUESTIONS CALL 800-537-5642



DUMP TUBE INSTALLATION INSTRUCTIONS

1. Tack weld the 2 EQ-715 dump knives on to 2 applicator knives. Make sure they are spaced evenly across your tool bar. NOTE: make sure the outlet of the knife faces the rear of the tool bar. If installed backwards the outlet of the knife will act as a scoop and plug up with dirt.
2. Install the 2 7550 dump outlet hose barbs into the super flow as shown on the diagram. Be sure to use pipe sealant on the male threads.
3. Cut the appropriate length of hose to run from the 7550 dump hose barb to the EQ-715 dump knife. Equal length of hose is not necessary however you must use hose clamps to each end of the hose to prevent it from coming off.

NOTE: Never tee the two lines together or tee the lines into your applicator hose. This will cause a reduction in the super flows capacity.

If you have any questions please call us at 800-537-5642.

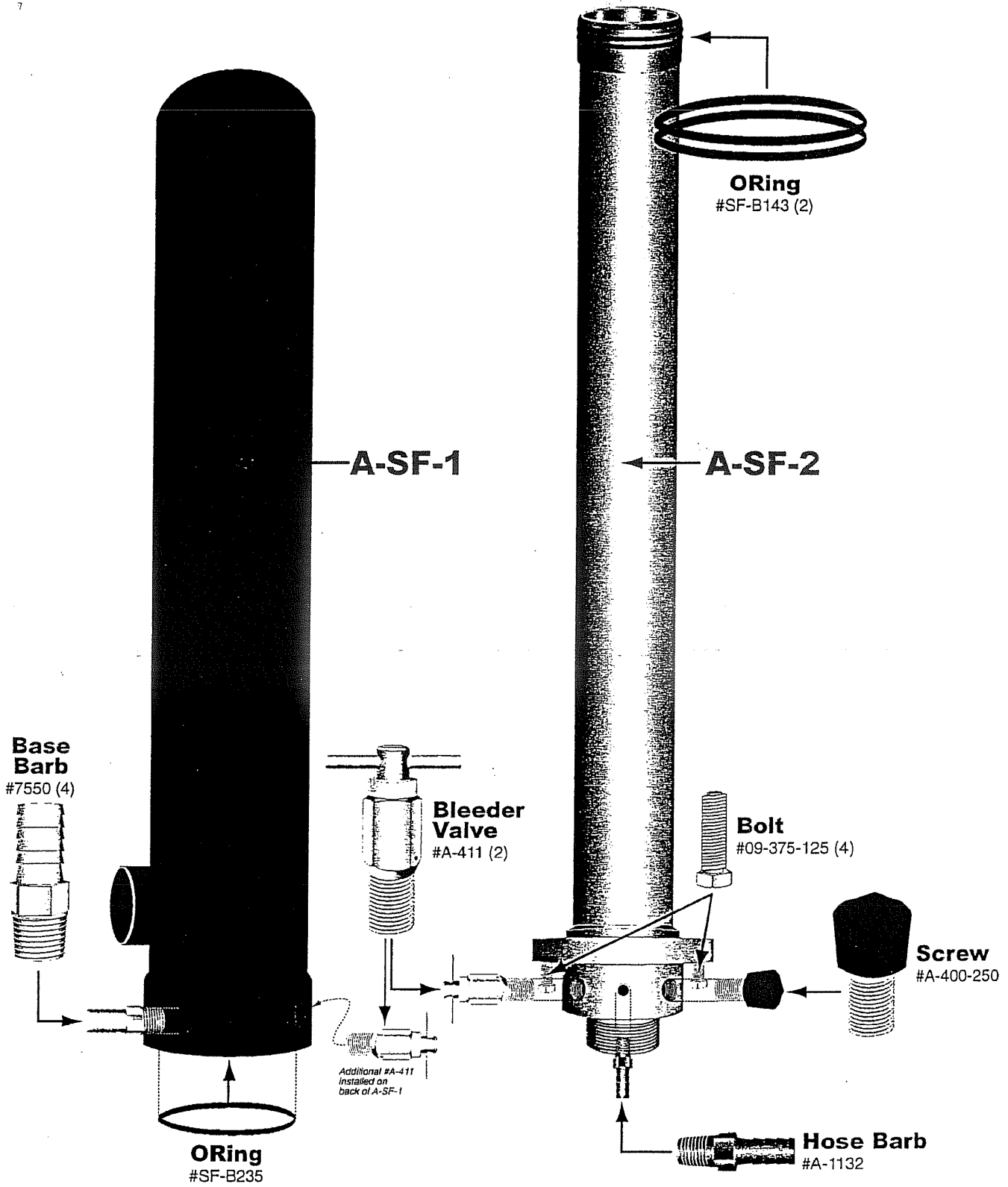

FIGURE 2