

INSTALLATION & OPERATION MANUAL



MODELS FM-40 & FM-40-1

USE OF FOAM MARKER

The foam marker is used to mark the working area with balls of foam. It eliminates the risk of overlapping and space gaps during the spraying process. The FM-40/FM-40-1 is designed to be very easy to install, operate and maintain. The foam marker operates independently from the PTO or other sprayer components.

COMPONENTS

The FM-40/FM40-1 has the following major components:

1. 4 gal. tank
2. 12 Vdc diaphragm air compressor
3. Right and left (on-off-on) switch box
4. Foam nozzle assembly
5. Power supply & compressor cable
6. Air-liquid tubing



OPTIONAL KITS

The Foam marker has one optional kit (not included in package):

- Extension drop

Note: Please call your distributor to order the optional kits.

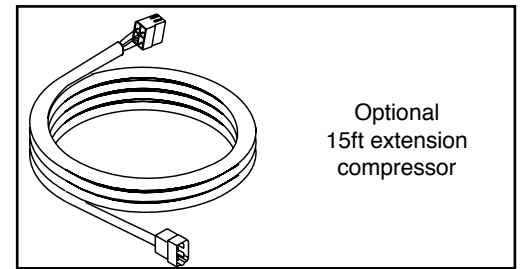

www.cds-johnblue.com

1-800-253-2583

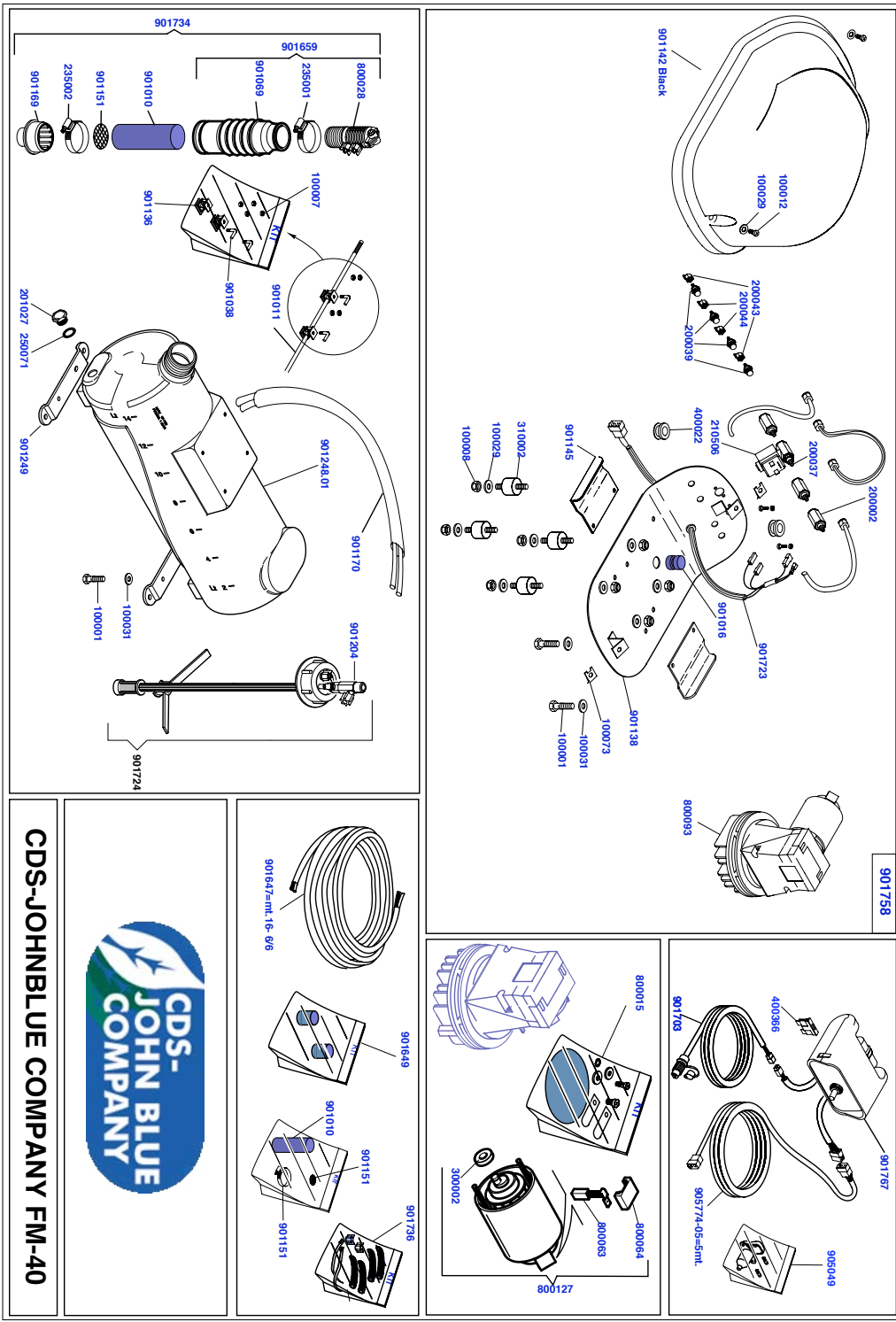

CDS-JOHNBLUE COMPANY FM-40

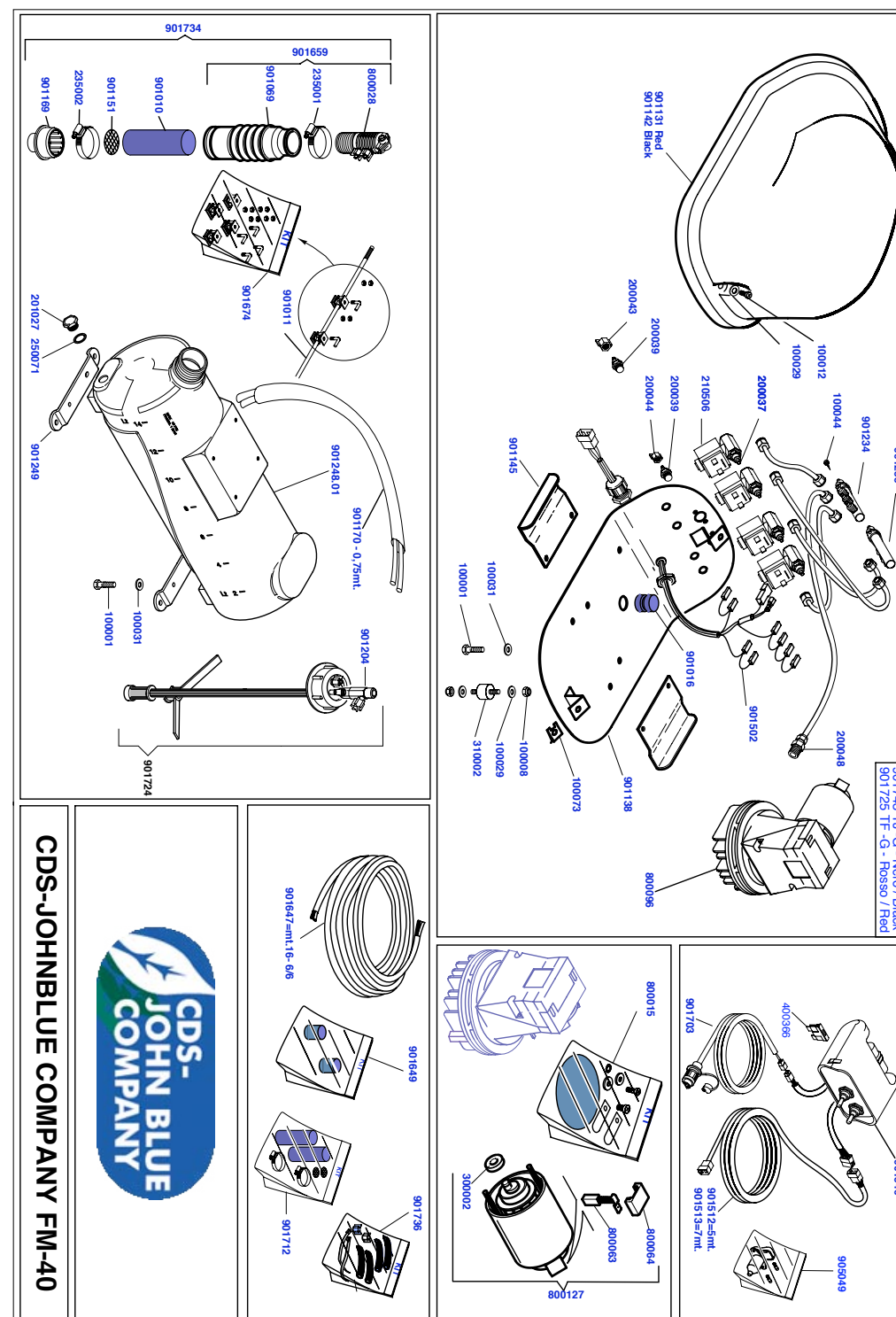

CDS-JOHNBLUE COMPANY FM-40



INSTALLATION PROCEDURES

IMPORTANT: Read all instructions before installing and operating the foam marker.

DIMENSION & WEIGHT

The weight of the FM-40 & FM-40-1 is 30 lbs. empty. Below you will find the overall dimensions.

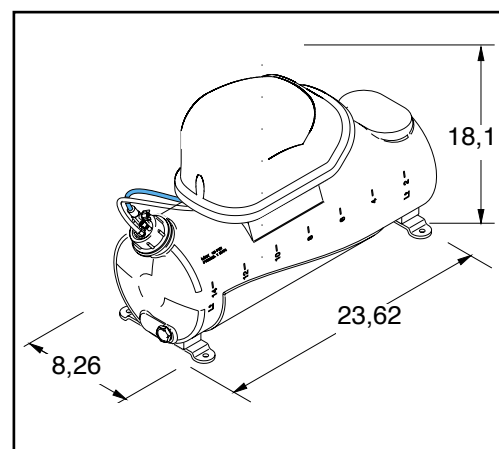

GENERAL INSTALLATION INSTRUCTIONS

The Foam Marker can be easily installed horizontally on the sprayer. However as a general rule it is important to choose a location for the compressor that shields it from exposure to chemicals during spraying operations.

The two foam drop nozzles must be fixed at the ends of the boom so that foam can fall at the edge of the end spray nozzle signaling the sprayed area.

Hoses for the air-liquid circuit must be clamped to the boom structure out of way of moving parts. Also, ensure hoses will not kink if and when booms are folded.

INSTALLATION OF SWITCH BOX AND POWER SUPPLY

- Determine the best location for the selector switch box in the tractor cab.
- Determine the best routing for the power cable. Make sure it is away from operator's movement area, away from moving parts and away from sharp objects.
- Using 3 bolts 1/4" (not included) and the provided slots, mount the switch box at the desired location.

- Mount the power supply disconnect within 6 feet, from selector switch box. First crimp one supplied pin contact to one red and one black 10 gauge wire (not included) and connect them to the proper socket. Next mount the power supply disconnect, by using the template supplied in the bag with the power supply socket, to drill a 1" hole in the center and two 1/4" bolt holes in the sides. Feed the two wires through the 1" drilled hole. Use 10-24 screws to bolt the disconnect. Finally, connect the other end of the red wire to the "+" side and the other end of the black wire to the "-" side of the 12 Volt battery.

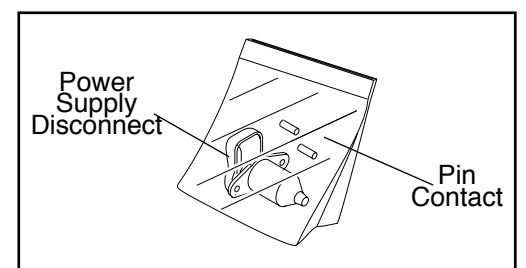
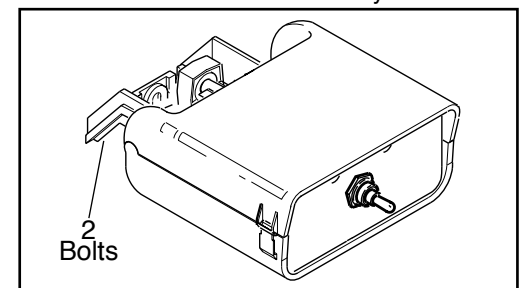

DO NOT CONNECT THE POWER CABLE INTO THE DISCONNECT UNTIL ALL WIRING IS COMPLETED.

INSTALLATION OF COMPRESSOR AND TANK

Mount the foam marker on a sturdy part of the sprayer structure. 4 bolts hole (11/32") are drilled on the tank brackets for fixture. Brackets are factory mounted on the tank. Please note bolts are not included.

AIR-LIQUID CONNECTION OF CAP

Air-liquid connection to the cap of the tank is factory mounted. However if they are not, connect the clear tube (air outlet) from the compressor to the white wing nut of the cap. Next connect the blue tube (liquid outlet) from the compressor to the blue wing nut of the of the cap.

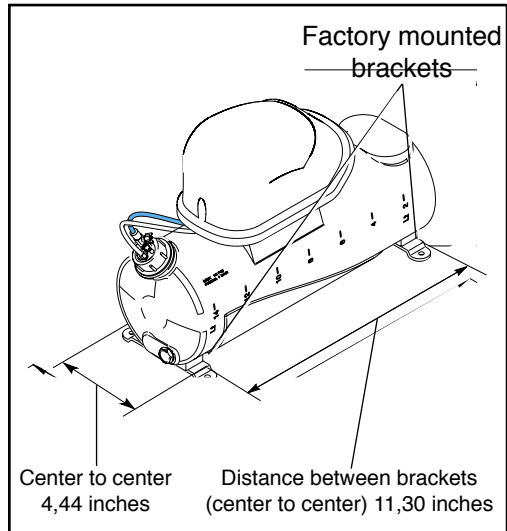
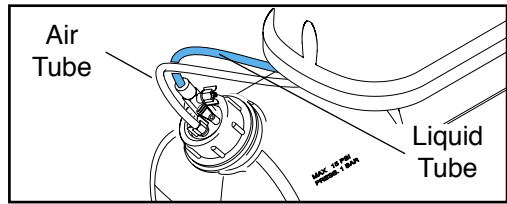

INSTALLATION OF FOAM NOZZLE ASSEMBLY

OPTION 1: use complete kit - 901674

- Drill two 1/4 inch holes on each side of

the boom (approx 5 inch apart)

- Insert two nuts (provided in the kit) in each foam nozzle support (one in the top slot and one in the bottom slot).

- Place each foam support on top of the drilled hole.

- Bolt each foam nozzle support using M6 bolts (the length of the bolt depends of the thickness of the boom. M6 Bolts are not provided).

- Slide first the rod in the two foam nozzle support, then in the foam mixer.

- Hand tight the foam nozzle supports with the "L" shaped bolt.

- Using a screw driver, thighten the rod in the foam mixer.

OPTION 2: Use clamps for fixture

For a fast and reliable fixture, one can use clamps to fix the foam nozzle support. Several different clamps might work. However, the following ones have been tested.

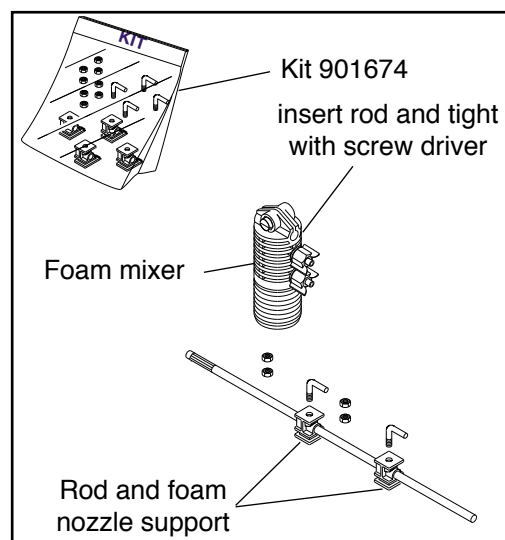

3

Teejet Vari-Spacing Clamps:

- QJ111 for round booms
- QJ11SQ for square booms

Delavan Quick Change Boom clamps:

- serie 50800-1 to 50800-5

CONNECTION OF POWER CABLE AND COMPRESSOR CABLE

With the compressor cable connect one end to the switch box and the other end to the compressor. The compressor cable is 23 ft. long. With the power cable connect one end to the switch box and the other end to the disconnect socket. The power cable is 6.5 ft. long.

DISTANCE FORM THE COMPRESSOR TO THE BOOM.

Being careful not to cut the tubing, cut the over sleeve back approximately 2" to expose the blue and clear tubing. Next, remove the blue wing nut from the foam nozzle connector and slip it on the blue tube with the thread facing away from the blue tube. Slide the blue tube all the way over the small tube on the foam nozzle. Slide the wing nut back to the thread and hand tighten. Follow the same steps for the clear tube and white tube nut. Finally install the opposite ends of the air-liquid tubes to the compressor.

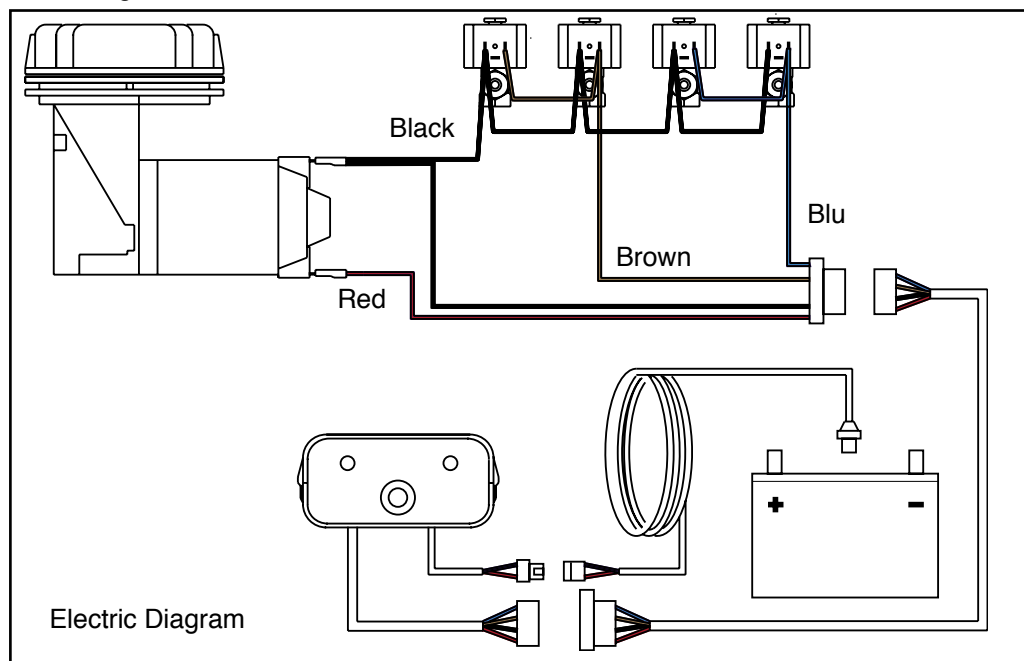

INSTALLATION OF AIR-LIQUID TUBING

Before installing the air-liquid tubing on the boom, make sure to take the proper measurements by unrolling the tubing side by side the boom.

DO NOT FORGET TO CONSIDER THE

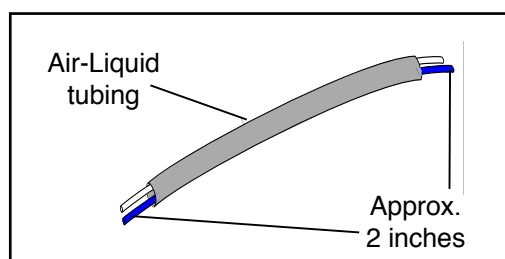

4

OPERATION

SWITCH BOX

The switch box is used to start the compressor and to select the side the foam will be made. To operate simply select "ON" left or "ON" right to direct the foam to the left or right side of the boom. Selecting "OFF" will not drop foam at all

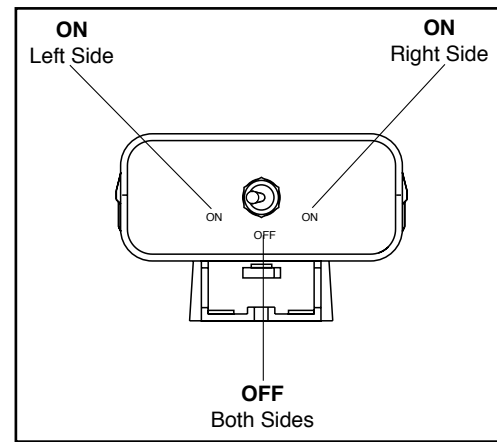

MIXING SOAP IN TANK & CONTROLLING THE FLOW

CAUTION: CONTENTS IN TANK MAY BE UNDER PRESSURE. WHEN REMOVING CAP FROM TANK, UNSCREW CAP SLOWLY TO RELIEVE PRESSURE OR USE THE INSTALLED RELEASE VALVE.

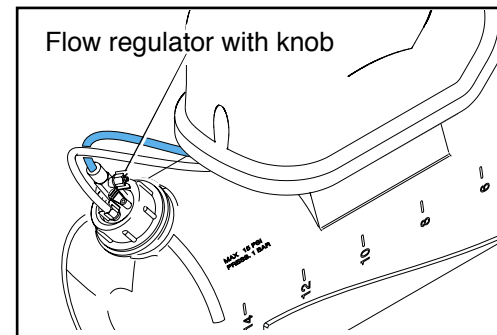

Remove cap from tank. Fill the tank with the desired amount of water first, and then

add soap to avoid making foam in the tank. Replace cap on the tank and tighten hand tight. When preparing soap mixture, one must first desire life span of the foam ball. Temperature, sun light, relative humidity, hardness of water, soap concentration and wind condition are some of the variables which effect the foam ball life span.

On the cap, there is a flow regulator to control the output of the foam liquid. By turning the knob clockwise, the foam ball output will be less frequent. By turning the knob counter clockwise, the foam ball output will be more frequent.

MAINTENANCE INSTRUCTIONS

CAUTION: BEFORE PERFORMING ANY MAINTENANCE, MAKE SURE THAT THE LIQUID SUPPLY LINE FROM THE TANK HAS HAD THE PRESSURE BLED FROM THE SYSTEM. TO DO THIS, UNSCREW TANK CAP ONE TURN OR UNTIL AIR IS HEARD LEAKING OUT AROUND CAP OR USE THE PRESSURE RELEASE VALVE.

PRECAUTIONARY STEPS

Flush the system with clean water after each use, especially when hard water has been used. Do not apply lubricating oils, grease or other petroleum products to the compressor motor assembly.

WINTERIZING

Follow the steps written below for proper winterizing:

Step 1: Relieve pressure from tank.

Step 2: Disconnect air and liquid tubing from tank.

Step 3: Connect air and liquid tubing

5

together with supplied tubing coupler.

Step 4: Disassemble foam nozzle to replace foam sponges (big and small).

Step 5: Empty tank off all soap to avoid freezing.

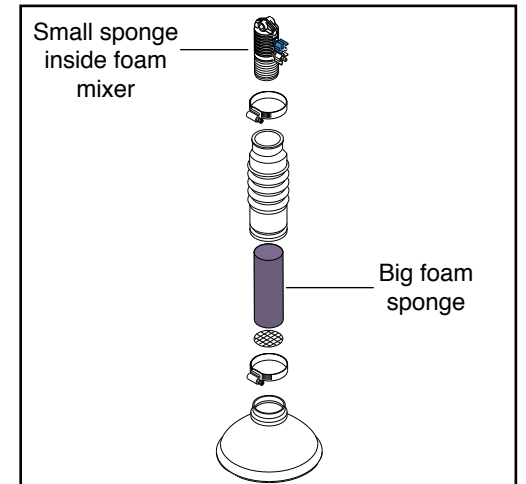
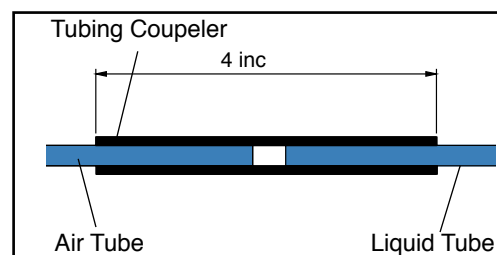

TROUBLESHOOTING

The following table summarizes different troublesome conditions.

CONDITION	POSSIBLE CAUSES	SOLUTIONS
1. Compressor will not turn on	A. Corroded connections B. Disconnected C. Improperly wired D. Blown fuse	A. Inspect and clean B. Check wiring C. Check wiring diagram D. Replace fuse
2. Foam does not come out from nozzle	A. No concentrate in tank B. Tank cap loose C. Compressor filter clogged D. Strainer in tank clogged	A. Add concentrate in tank B. Tighten cap C. Clean or replace filter D. Clean or replace strainer
3. Foam ball does not form completely	A. Soap concentrate to low B. Restrictor not in place C. Water to hard	A. Dump and remix higher B. See foam nozzle assembly in parts break down C. Use water softener with concentrate
4. Compressor does not start when switching side	A. Check valve broken on tank cap B. Switch broken	A. Try cleaning cap check valve by blowing air. If problem persists change cap B. Change switch
5. Foam marker is off but air or liquid are still coming out	A. Valves are dirty B. Valves are broken	A. Blow air in the valves B. Replace broken valves

6