

RoadMaster™



REFERENCE MANUAL

Pulse Width Modulated (PWM) Version



MICRO-TRAK®
SYSTEMS, INC.

ROADMASTER™

PWM Version

REFERENCE MANUAL

The ROADMASTER™ is an electronic control system that can help you operate more cost-effectively by providing the information you need to maintain proper application rates of liquid de-icer and anti-icing chemicals.

The ROADMASTER™ has been designed for easy installation and operation. However, since each installation will vary depending on your equipment, please take time to familiarize yourself with this manual and the actual components before beginning. Following the procedures described in this manual will ensure proper performance and help avoid problems or questions once you are on the road.

This manual is written for the PWM version ROADMASTER™. Please read the manual carefully and follow the instructions as they apply to your usage.

If you do encounter a problem that cannot be corrected by reviewing this manual, consult Micro-Trak Systems, Inc. for assistance.



MICRO-TRAK®
SYSTEMS, INC.

P. O. Box 99 • 111 East Leray Avenue
Eagle Lake, MN 56024-0099
800-328-9613 • 507-257-3600 • Fax: 507-257-3001
www.micro-trak.com • trakmail@micro-trak.com

Copyright © 2017 Micro-Trak Systems Inc.

Micro-Trak® Warranty

Micro-Trak (herein "Seller") warrants to the original purchaser (herein "Buyer") that, if any product or part of the product (herein "part") proves to be defective in material or workmanship, upon inspection and examination by Seller, within one (1) year from the original date-of-purchase, and is returned to Seller with dated proof-of-purchase, transportation prepaid, within thirty (30) days after such defect is discovered, Seller will, at their option and sole discretion, either repair or replace said part, except that the warranty for expendable parts, including but not limited to, light bulbs and batteries shall be thirty (30) days from the original date-of-purchase. Said warranty is valid only when the part has been installed, operated and maintained in strict accordance with the procedures outlined in the manual. Any damage or failure to said part resulting from abuse, misuse, neglect, accidental or improper installation or maintenance, unauthorized modification, use with other products or attributable to acts of God, as determined solely by the Seller, will invalidate the warranty. Said part will not be considered defective if it substantially fulfills the performance specification. Buyer shall be responsible for all maintenance services, if any, all in strict accordance with the procedures outlined in the manual. The warranty does not include labor, installation, replacement parts or repairs, delivery of replacement parts or repairs or time and travel. Said warranty is nontransferable.

THE FOREGOING WARRANTY IS EXCLUSIVE AND IN LIEU OF ALL OTHER WARRANTIES OF MERCHANTABILITY, FITNESS FOR PURPOSE AND OF ANY OTHER TYPE, WHETHER EXPRESS OR IMPLIED. The Seller's liability, whether in contract, in tort, under any warranty, in negligence or otherwise, shall not exceed the return of the amount of the purchase price paid by the Buyer, and under no circumstance shall the Seller be liable for special, indirect or consequential damages. Seller neither assumes nor authorizes anyone to assume for it any other obligation or liability in connection with said part. No action, regardless of form, arising out of the transactions under this agreement may be brought by the Buyer more than one (1) year after the cause of action has occurred.

Seller agrees to extend the term of the foregoing warranty period should the Buyer return completed warranty registration information, with dated proof-of-purchase, to the Seller within one (1) year from the original date-of-purchase. All conditions and limitations of said foregoing warranty, except the term of said foregoing warranty, shall apply. Said term shall be extended to a total of three (3) years from the original date-of purchase on display consoles and network communication modules, as defined by Seller, and said term shall be extended to a total of two (2) years from the original date-of-purchase on all other parts, except that the warranty for expendable parts, including but not limited to, light bulbs and batteries shall be thirty (30) days from the original date-of-purchase, and except that the warranty for parts manufactured by someone other than the Seller, including but not limited to, shut-off and control valves, DGPS receivers, memory cards and drives, mapping software, flowmeters and pressure sensors shall be one (1) year from the original date-of-purchase.

Units under warranty should be sent prepaid, with dated proof-of-purchase, within 30 days of discovering defect, to the address below:

MAIL AND UPS:

**Micro-Trak Systems, Inc.
Attn: Service Department
111 East LeRay Avenue
Eagle Lake, MN 56024-0099**

Extended Warranty Option

It's simple! Just complete the registration for this product **ONLINE** at www.micro-trak.com and we'll extend your warranty for up to three years*, at no additional charge.

Registration information is for internal use only.

* Some limitations apply. See warranty statement for details.

At Micro-Trak Systems, we believe a product that delivers quality and performance at a low cost is what is needed to help today's operator and the operator of the future compete in the world market.

It is our goal to provide operators with a line of electronic equipment that will help build and maintain an efficient and profitable operation that can be passed on to future generations.

We thank you for your purchase and hope that we can be of service to you in the future.

Micro-Trak Systems, Inc.

Table of Contents

Warranty.....	3
Table of Contents	4-5
Component Parts and Assembly Hardware.....	6
ROADMASTER™ PWM System Diagram.....	7
ROADMASTER™ PWM Wiring Diagram.....	8
Installation.....	9-12
Mounting the Display Console.....	9
Attaching the Power and Run/Hold Control Switches	9
Electrical Installation	10
ROADMASTER™ PWM Section Connections	10
Speed Sensor Installation	11
Speed Sensor Options	11
Mounting and Plumbing Flowmeter	11
Installing Flow Sensor Cable	11
Installing PWM Valve.....	12
Installing Optional Tank Level Switch	12
Installing External Blast Switch.....	11
ROADMASTER™ PWM Console Functions.....	13
Calibration	14-17
Entering Calibration Values	14
Flow Cal, Min Flow, Adjust Rate, Target Rate, Width Cal, Speed Cal, Mode Sel	14-16
Radar or GPS Speed Sensor Calibration Table.....	16
Test Speed.....	15
Exiting Calibration.....	16
Default Calibration Values.....	16
Calibration Log Sheet	17
“Special” Calibration.....	18-22
Entering “Special” Cal Values	18
“Special Cal” Pages.....	18
Default “Special” Calibration Values.....	18
Page One	
Fill Tank Size, Tank Alarm Set Point, Blast Duration, Blast Target Rate, Units (English or Metric), Vehicle Number, Valve Speed	19
Page Two	
Alarm Minimum Speed, Start Time, Valve Start Percentage, Auto Delay Time, Set Year, Set Month, Set Date, Set Time.....	20
Page Three	
Manual Enable, Flow at Minimum PWM, Minimum PWM, Alarm Enable, PWM Frequency, Flow @ Maximum PWM, Maximum PWM, Closed/Open Loop.....	21-22
Operation.....	23-26
Console Power/System On/Off, Display, Run/Hold Switch, Auto/Man Button, Blast Button, “+” and “-” Buttons, Section Switches, Warning Device, Audible Alarm, Rotary Switch, Emergency Stop.....	23-24
Rotary Switch Positions	
Volume, Volume/Minute, Tank Level, Serial Port, Rate, Area, Distance, Mode, Speed.....	24-25
Resetting System Counters.....	26
Pre-Application System Checkout	27
Care and Maintenance of your RoadMaster PWM Console.....	27
ROADMASTER™ PWM Live Calibrate.....	28-32
Closed and Open Loop operation.....	28
Closed Loop Operation Only.....	29-30
Open Loop Operation Only	31-33

Table of Contents (cont)

Troubleshooting	34-36
Messages/Warnings.....	34
General	35
Console Appears Dead	35
Speed is Always Zero or Erratic	35
Area Count is Inaccurate.....	35
Distance Count is Inaccurate.....	35
No Readout of Gallons (liters) or Gallons per Minute (liters per minute)	35
Total Liquid Used is Inaccurate.....	35
Electrical Interference	35
Displayed Measurements do not Make Sense.....	35
Display Reads "99999"	35
Checking Individual Components.....	36
Console Inputs.....	36
Speed Input	36
Flow Input.....	36
Tank Switch Input	36
Run/Hold Input:.....	36
Harness	36
Magnetic Hall-Effect Speed and Flow Sensors	36
Astro II and Astro 5	36
Vansco Radar Speed Sensor	36
Electric Section Valves	35
Plumbing	36
Plumbing Guidelines	37
General	37
Pump Inlet.....	37
Flowmeter	37
Pump.....	37
Appendices	38-50
Appendix A: Optional Speed Sensor Mounting Installation.....	39-41
Appendix B: Calibrating if Using a Magnetic Speed Sensor.....	42
Appendix C: Fine Tuning Speed/Distance Calibration Value	43
Appendix D: Fine Tuning Flowmeter Calibration Value	44
Appendix E: Flowmeter Assembly.....	45
Appendix F: Radar "Y" Adapter Cables.....	46
Appendix G: Conversion Chart.....	47
Appendix H: Data List for Data Logging On-The-Go	48
Appendix I: Totals Data List for Downloading Accumulated Data.....	49
Appendix J: Replacement Parts List	50

Component Parts and Assembly Hardware

Before beginning installation, check the carton contents for the following items:



ROADMASTER™ PWM Console
P/N 17546

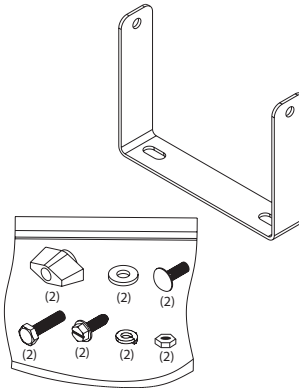

Console Mount Kit
P/N 13181

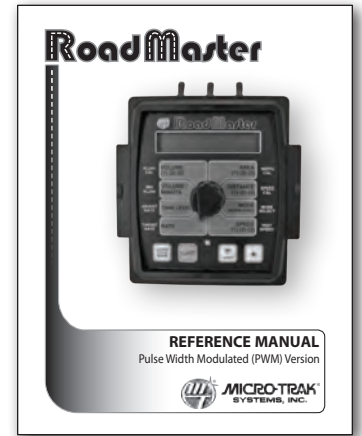

Reference Manual
P/N 17545

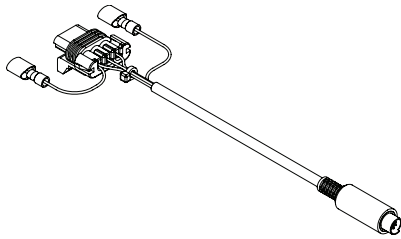

Cable, Remote Hold/Blast
P/N 17523

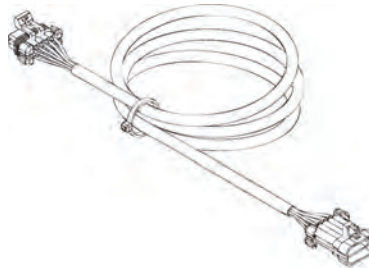

10' 10-pin M/P Extension Cable
P/N 14316

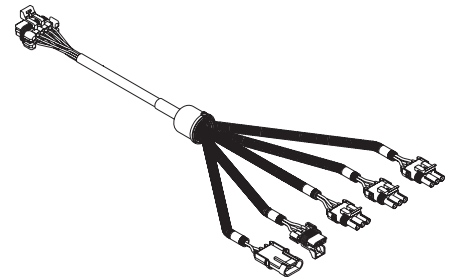

10' Branch Cable
P/N 14313

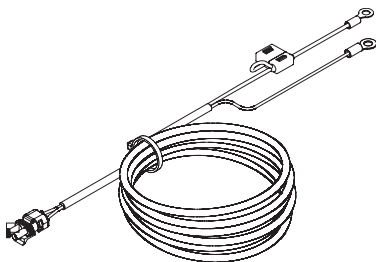

15' Battery Cable
P/N 14315

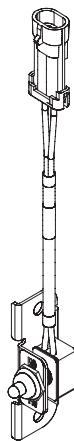

Power Switch
P/N 21779

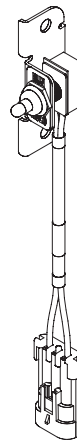

Run/Hold Switch
P/N 21778

ROADMASTER™ PWM System Diagram

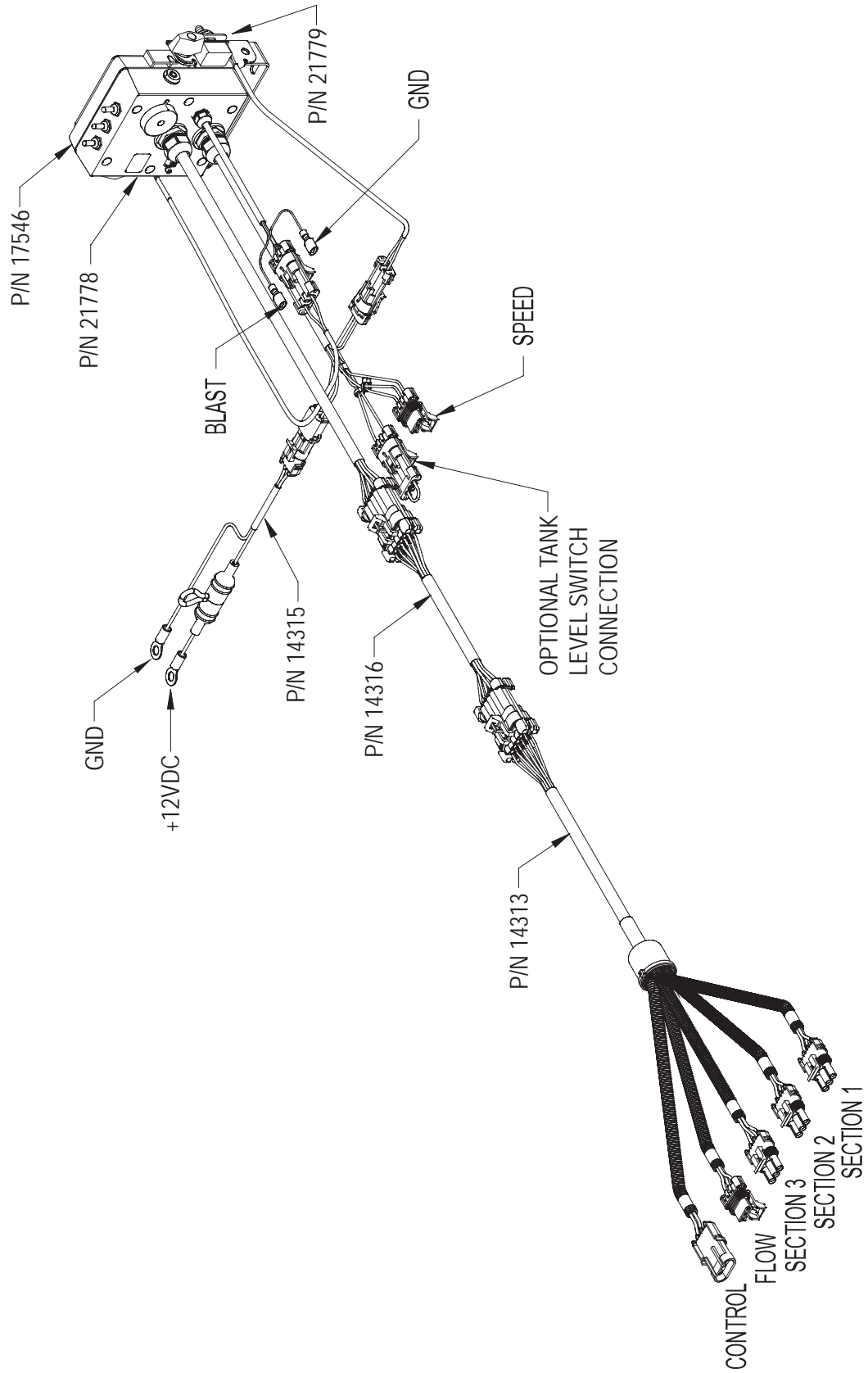

ROADMASTER™ PWM Wiring Diagram

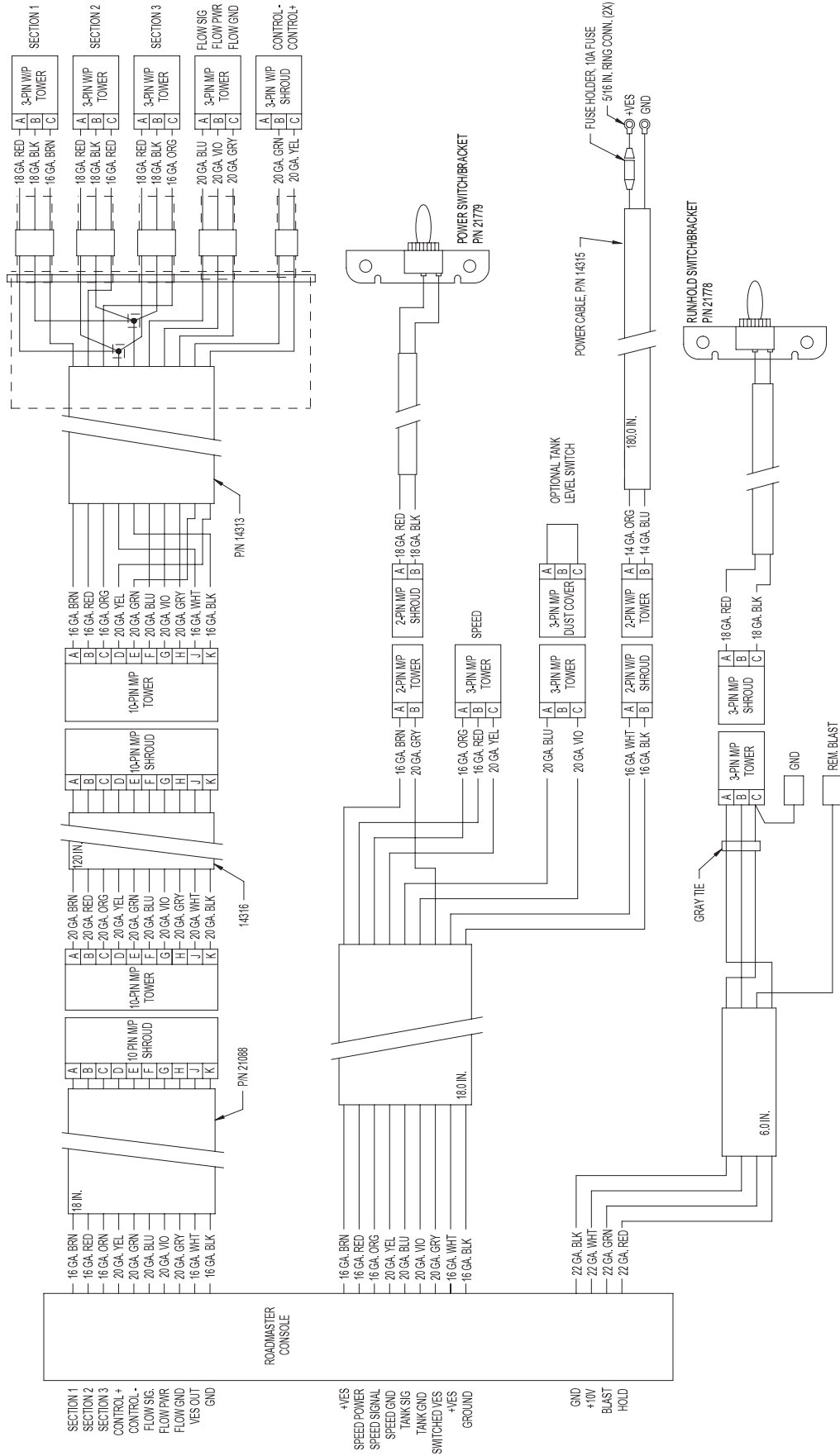

Installation

Mounting the Display Console

Select a mounting location which seems most workable, and best fits your needs. It should be convenient to reach and highly visible to the operator. **DO NOT INSTALL IN A POSITION THAT OBSTRUCTS THE VIEW OF THE ROAD OR WORK AREA.** Whenever possible, avoid locations that expose the console to direct sunlight, high temperature, strong chemicals or rain.

1. Place the mounting bracket in the selected location, mark holes, drill 1/4" (7mm) holes. Use self-tapping screws if not practical to use bolts - drill 3/16" (5mm).
2. Mount bracket with bolts, lock washers and nuts provided. See Illustration 1.
3. Place rubber washers on carriage bolts and insert the bolts through the bracket holes from the inside out.
4. Place console over carriage bolt heads.

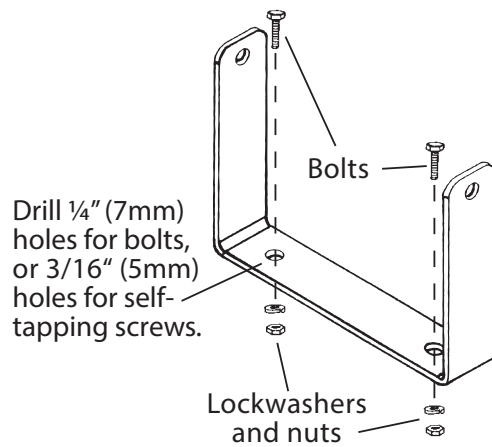

Illustration 1

Mounting the Switch Kits

See Illustration 2 - Run/Hold Switch shown.

1. Place the Run/Hold switch bracket over the carriage bolt on right side and hold against the console bracket.
2. Thread on the mounting knob onto the carriage bolt and tighten to secure the console and Run/Hold switch bracket in place.
3. Join the Run/Hold switch harness connector into the mating connector (gray tie) on the console harness.

NOTE: Continue by installing the Power Switch to opposite end of console bracket using steps described above. Then connect the Power Switch cable connector (2 pin) to the mating connector on the console harness.

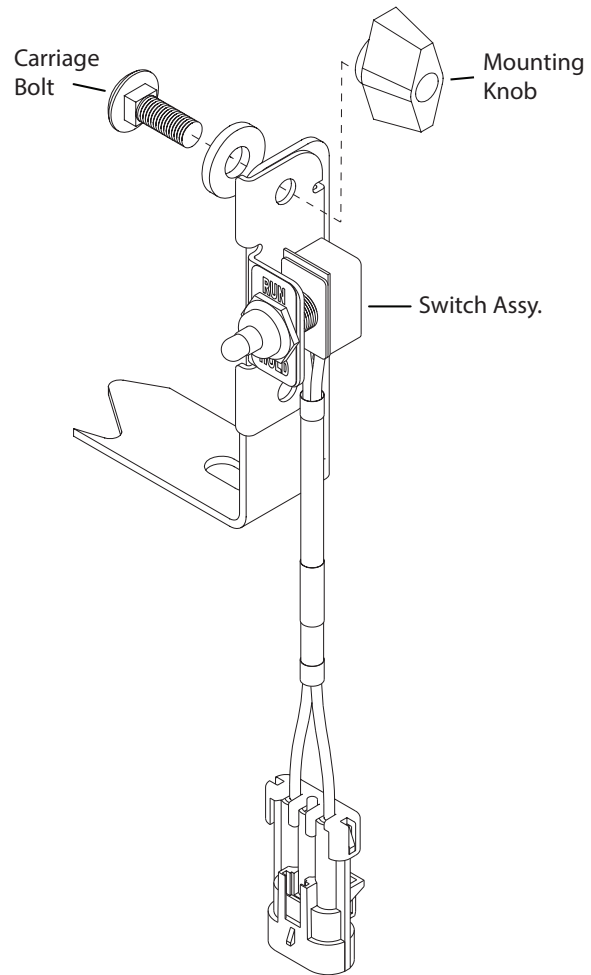

Illustration 2

Console Run/Hold Switch shown

Installation (cont)

Illustration 3

Electrical Installation

NOTE: ROADMASTER™ PWM must be connected to a 12-volt DC negative ground electrical system.

POWER/BATTERY CONNECTION:

Locate the power cable for the ROADMASTER PWM and route to the battery. When routing cable to console, avoid areas where the cable may be subjected to abrasion or excessive heat. Attach the BLUE wire (ground) to a screw or bolt on the equipment frame. *See Illustration 3.* Be sure there is a good metal-to-metal contact. Connect the ORANGE wire to the positive battery terminal.

Connect the power to the ROADMASTER™ PWM console by plugging the 2-pin W/P tower on the power cable into the 2-pin W/P shroud of the display console.

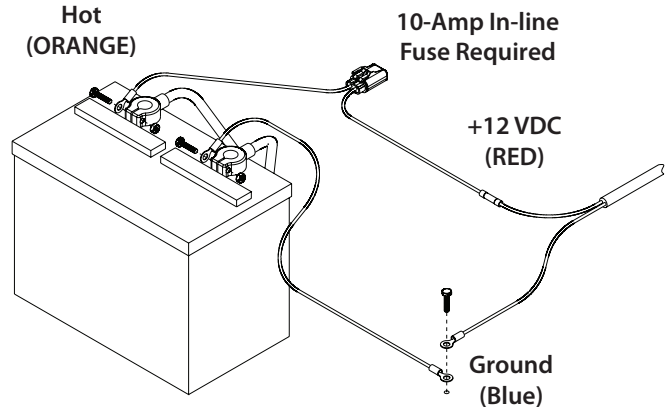

ROADMASTER PWM Section Connections

SECTION SHUT-OFF VALVES: Locate section valve connection. Join connectors to appropriate section valves.

NOTE: When using the system in LANE MODE, Section 2 defines the Lane Width. If only using one section valve, connect the Section 2 connector to it and use the Section 2 (center) switch on the console to control it.

Section connectors wiring detail



10' Flow/Control/Section Harness wiring P/N 14313

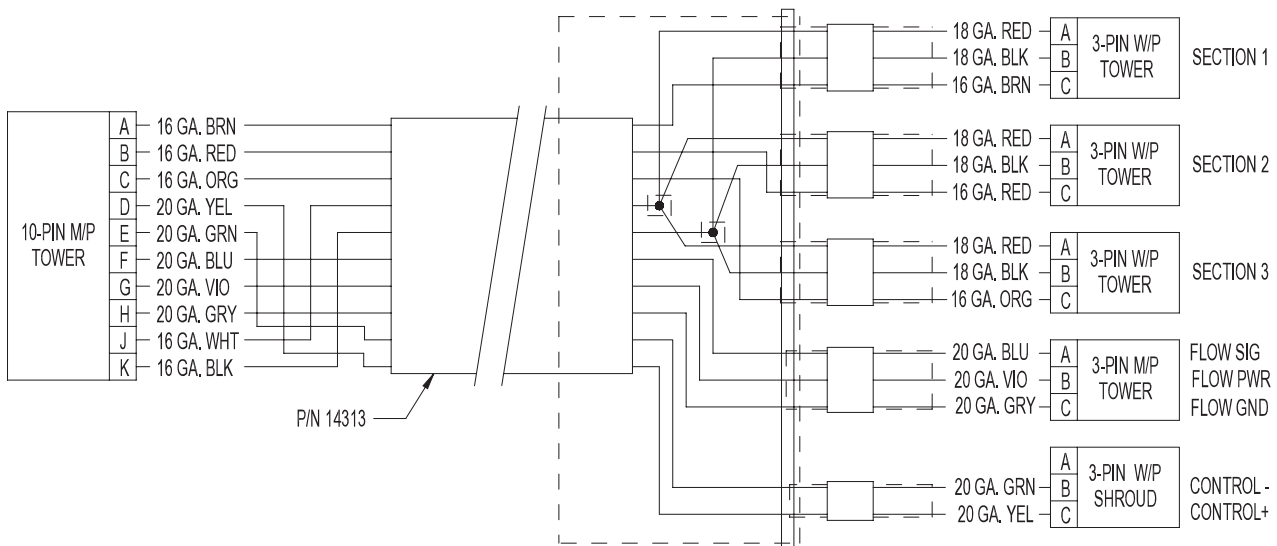

Installation (cont)

Speed Sensor Installation

Installation Note: The harness provides local connection for the speed sensor. For speed sensor installations on implements, add 3-pin extension cables as required.

Please Note: If you have purchased an Astro GPS Speed Sensor, a Vansco radar or other radar or GPS speed sensor, install the Astro, the Vansco or other radar as described in the instructions included with the unit. You may need an adapter cable to connect to radar or GPS Speed Sensor, see Appendix F.

NOTE: If using a Micro-Trak Magnetic Speed Sensor kit, See Appendix A.



SPEED SENSOR OPTIONS

In addition to the standard Hall-effect magnetic speed sensor, the ROADMASTER™ PWM may be interfaced with a variety of other speed sensing equipment. Several options are listed below.

ASTRO SERIES OR OTHER GPS SPEED SENSOR INTERFACES

The ROADMASTER™ PWM may also be used with most GPS speed sensors that output a pulsed signal, such as the Micro-Trak Astro 5, SkyTrak or Dickey-John GPS speed sensors. An adapter cable may be required.

VANSCO™ RADAR SPEED SENSOR

The Vansco radar speed sensor uses a microwave (radar) signal to deliver a reliable, accurate speed signal for electronic equipment. It features state-of-the-art electronic design/manufacturing, rugged aluminum housing and complete testing and certification.

RADAR INTERFACE

The ROADMASTER™ PWM may also be interfaced with most popular radar ground speed sensors. An adapter cable is required for proper interface.

SEE APPENDIX F FOR LIST OF ADAPTER CABLES FOR RADAR.

The flowmeter must be installed in the main line after any strainers, return lines, or valves. Securely mount flowmeter in an area away from intense vibration. A vertical installation with flow entering the bottom is preferred, especially at rates below 5 gallons per minute. Other orientations are sufficient providing the flowmeter remains full of fluid. To avoid erratic flow readings allow a minimum of 6" of straight tubing at the flowmeter input and output. If installation constraints don't allow this keep bends as gentle as possible. Micro-Trak flow meters are bidirectional (exception: green plastic turbine and mag flowmeters are one direction only). Flipping the flowmeter periodically (black nylon and stainless steel Micro-Trak manufactured models) to reverse the flow will greatly extend the life of the flowmeter by evening out bearing wear.

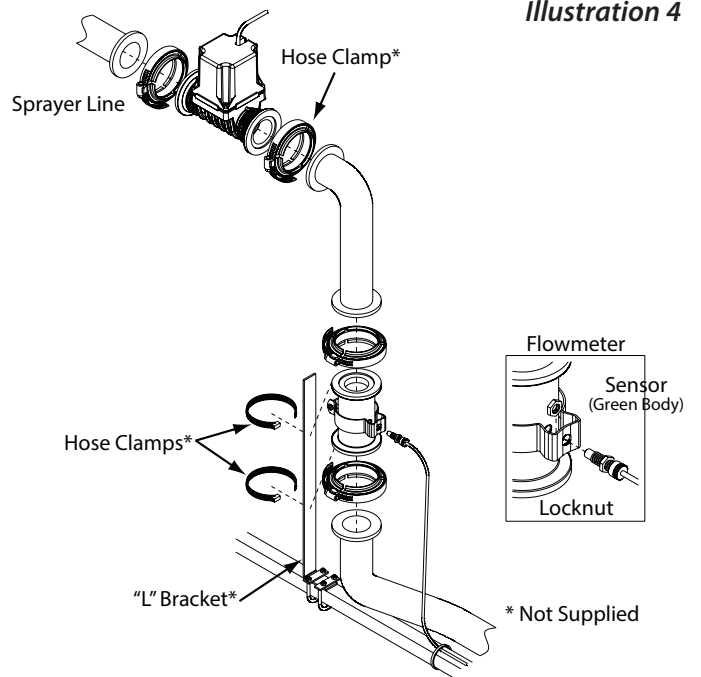

Installation (cont)

Speed Sensor Installation

With flowmeter in place, install the flow sensor cable.

The flow sensor cable has a GREEN sensor body and mates with the main harness cable, having a GREEN cable tie near the 3-pin M/P connector. Spin the jam nut on sensor threaded housing until it stops, insert threaded portion of sensor through bracket on flowmeter. Place second jam nut under bracket, hold and turn sensor into second nut. With sensor touching flowmeter body, tighten both jam nuts to lock sensor in place.

Route the flow sensor cable to meet the extension cable from the main harness flow connector marked with GREEN tie. Align connectors and press firmly together until locking tab clicks into place. Secure cable with ties provided. See *Illustration 5*.

NOTE: Sensors with GREEN bodies can be used for either SPEED or FLOW.

5' Hall-effect Flow Sensor Cable with Threaded Sensor Connector Green Body

Illustration 5

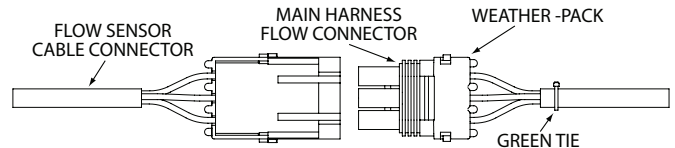
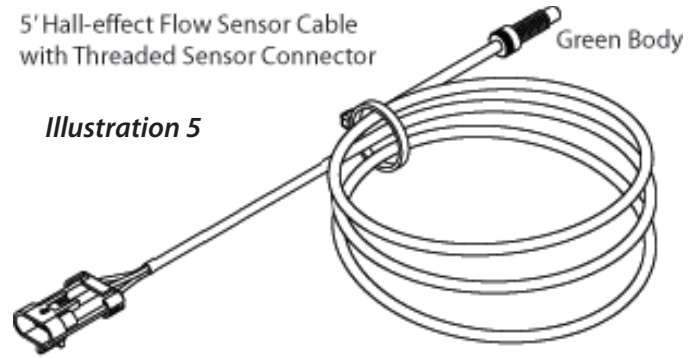

Connect flow sensor cable to GREEN-tie console cable.

NOTE: To maintain proper color codes, use the colored cable ties (GREEN) on the extension cable from the main harness flow connector.

Installing PWM Valve

Route the servo output to the PWM Valve, using 3-wire Weather Pack extension cables if necessary. Connect to the PWM Valve, observing polarity markings. An adapter or splices may be required.

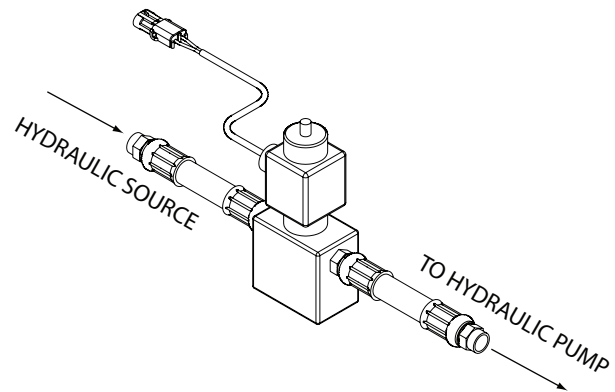

Installing Optional Tank Level Switch

A connection (See *Wiring Diagram on Page 8*) is provided for a "Tank Empty" switch. The switch must be a 2-wire, closed when tank is NOT empty and open when tank IS empty. Remove jumper and add 3-pin extension cables as required to reach the switch.

Installing External BLAST Switch

An optional external Momentary On BLAST switch can be connected to the two quick-connect terminals provided on the harness (See *Wiring Diagram on Page 8*). The remote BLAST switch allows the operator to control the BLAST function from a switch mounted on an armrest or other convenient location. An optional switch box that includes the BLAST switch and RUN/HOLD switch is available from Micro-Trak Systems, Inc.

ROADMASTER™ PWM Console Functions

The ROADMASTER™ PWM features a large, easy-to-read liquid crystal display, rotary dial and lighted panel for night use.

Rotary Switch Position Functions

KEYLOCK FUNCTION: When locked allows the user to view calibration values but prevents changes, allows Data Set 1 to be cleared but prevents clearing Data Sets 2 & 3 (Volume, Area, Distance, Average & Highest Velocity).

TANK ALARM: Can be initiated by either the optional Tank Level Switch or the Tank Counter (If Tank Alarm is set in "Special" Calibration).

REMOTE BLAST SWITCH - Optional: The Optional Remote Blast Switch can initiate the BLAST sequence in normal operation, the same as the console BLAST switch.

AUDIBLE ALARM: Alarm will sound for Rate errors over 10%, Tank Level below set point or Tank Empty (from Float input). The alarm can be temporarily shutoff by setting rotary switch to MODE (Alarm Reset) and pressing the RESET button. **Note: Setting ALARM ENABLE to OFF in "Special" Calibration will disable All Audible Alarms.**

VOLUME (1) (2) (3): Displays total gallons (liters) of liquid applied. May be reset. **SEE NOTE**

VOLUME/MINUTE: Displays total gallons (liters) of liquid applied per minute.

TANK LEVEL: Displays gallons (liters) of liquid remaining. If a FILL TANK SIZE has been set to a value in Calibration, pressing the "+" will make the Tank value jump to FILL TANK SIZE value. The value can be decreased but not increased above the FILL size. If the FILL TANK SIZE is set to Zero, Tank level can be adjusted to any value from 0 to 65,535 using the "+" or "-" (RESET) keys

RATE: Displays application rate.

WARNING LIGHT: Indicates over or under application of plus or minus 10% from the Target Rate or if the tank is low or minimum flow active. Also lit when in CAL. and Unlocked.



AREA (1) (2) (3): Keeps a running count of the total area worked. May be reset. **SEE NOTE**

DISTANCE (1) (2) (3): Displays distance traveled. May be reset. **SEE NOTE**

MODE: Displays selected mode. User selects between Lane, Ag, Dust and Turf Modes of operation. Allows Audible Alarm to be RESET by Pressing the RESET button.

SPEED (1) (2) (3): Displays ground speed in miles per hour (kilometers per hour) or Average & Highest velocity. May be reset. **SEE NOTE**

NOTE: VOLUME, AREA, DISTANCE & SPEED counters work in sets. If the

VOLUME counter 1 is reset, it also resets AREA counter 1, DISTANCE counter 1 and Average & Highest Speed counter 1. This will be the same for resetting any counters in the set.

Calibration Positions

FLOW CAL: Enter the calibration value assigned to your flowmeter (see flowmeter tag.)

MIN FLOW: Enter the minimum flow rate of the application system.

ADJUST RATE: Enter an amount of change for on-the-go adjustments to the target rate.

TARGET RATE: Enter the target application rate.

Calibration Positions

WIDTH CAL: Enter the working width.

SPEED CAL: Enter the speed calibration number in inches (cm) per pulse.

MODE SELECT: Allows the user to change the MODE Select between modes of operation. Lane, Ag, Dust and Turf.

TEST SPEED: Simulates ground speed for system checkout.

Soft Key Functions



Key which changes operation from automatic control to manual. (If Manual Control is enabled, see page 21).



Multi-functioned key:

- Used to enter & exit the calibration and "special" calibration modes.
- Used to initiate BLAST sequence in normal operations
- Overrides flowmeter input in case of an Emergency Stop.
- Toggles between SPEED CAL and Distance traveled while fine tuning the SPEED CAL factor or between FLOW CAL and Volume when fine tuning the Flow Cal factor. *See Appendices C & D.*



PROGRAM KEYS: In normal operating modes, used to increase/decrease application rate. With Rotary Switch in the SPEED position, RESET key is used to display Average and Maximum Speed. In Volume, Area, Distance or Speed, the "+" key selects counter set.

- RESET: When in Hold and not in CAL, clears the selected counter **set** when held for two seconds. When rotary switch is in the MODE position, Resets Audible Alarm.
- When in CAL, the "+" key increases and the "-" decreases the calibration value displayed.

Calibration

Entering Calibration Values

To enter or change any of the system’s calibration values, you must enter calibration.

NOTE: *UNITS (English or Metric) must be set in “Special Calibrate before any other CALIBRATE or “SPECIAL CALIBRATE values.*

TO ENTER CALIBRATION DO THE FOLLOWING

While in HOLD or with all non-zero section switches Off and no ground speed (stopped), holding the BLAST key for one(1) second will toggle CALIBRATE on. The CAL icon will turn on and any of the following eight Calibrate values can be viewed/changed.

If the Console is unlocked, the Warning LED will also turn on and any of the CALIBRATE values can be adjusted.

If the Console is locked, the Warning LED will not turn on and the CALIBRATE (except TEST SPEED) values can only be viewed and cannot be adjusted. TEST SPEED is active whether locked or unlocked.

Once in calibration mode, you may change any one, all, or none of the values, in any order but it is recommended to set MODE first.* To select a calibration position, simply turn the rotary selector to the desired position. Calibration positions are identified by the WHITE labeling on each side of the rotary selector. All values are entered and adjusted using the “+” and “-” buttons on the front panel.

To exit Calibrate and save changes, hold the “BLAST” key again for 1 second to exit calibration. “CAL” will disappear from the display and normal operations will start..

If you decide not to save the changes made, power-down the console without pressing BLAST. Any changes will be restored to the original values when power is restored.

*Test speed must be last.

FLOW CAL: This position is used to calibrate the flow meter for accurate liquid measurement. Enter **FLOW CAL** the factory calibration number stamped on the flowmeter tag (See Illustration 7) The Flow Cal number should not be changed during operation because a change in the Flow Cal number will also change some counter values.

NOTE: If using Open Loop control, the default setting should be left unchanged.

NOTE: Your ROADMASTER™ PWM flowmeter has been tested at the factory and assigned a “FLOW CAL” value to make it operate properly with the ROADMASTER™ PWM console. This number is stamped on a tag attached to the flowmeter. See Illustration 7. This is a starting point only. If your spray solution has a specific gravity or viscosity that is different than water, flowmeter calibration should be done for the specific solution. (Please refer to Fine-Tuning Flowmeter Calibration in Appendix D)

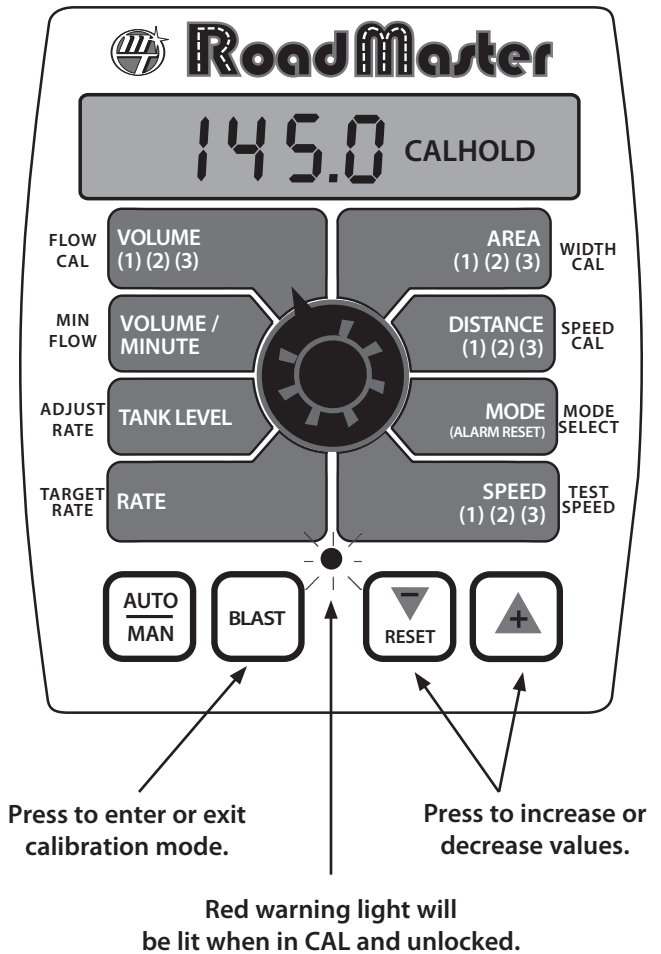
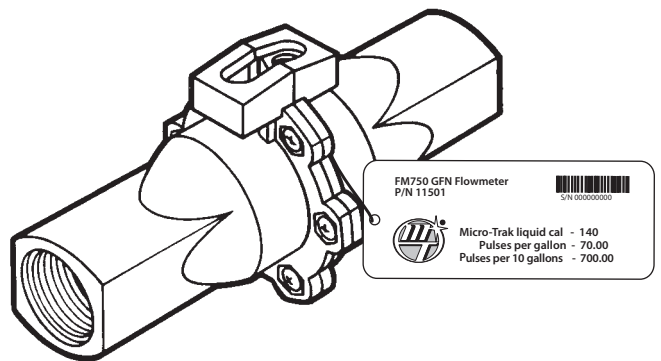

Illustration 7



Calibration (cont)

Entering Calibration Values (cont)

MIN FLOW: Displays the Minimum Volume/Minute from 0.0 to 6,553.5 assuming all non-zero width section switches are turned on. The purpose of this calibration setting is to prevent the system from applying below the recommended minimum flow rate for the nozzles. Enter the minimum flow rate in gallons per minute (liters per minute) based on the nozzles being used, for the entire width of the applicator. DO NOT enter the target flow of your spray application. For example: If the minimum flow rate for the nozzle you are using is .22 GPM at their minimum recommended pressure and your spray boom has 20 nozzles, enter 4.4 as the MIN FLOW value (.22 x 20 = 4.4). The system WILL NOT apply at a rate lower than this value when spraying in AUTO. The Warning LED will FLASH whenever the system is applying at Minimum Flow Rate but the Audible Alarm will not sound. This value should be checked/ changed for each different nozzle that you use.

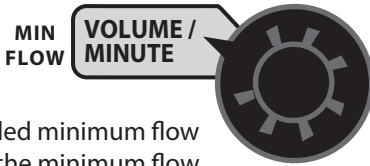

ADJUST RATE: Displays the ADJUST RATE or "step size from 0.0 to 655.35 in Ag, Lane or Turf mode and .000 to 65.535 in Dust mode. In AUTO control with RATE selected, pressing "+" or "-" (RESET) will change the TARGET RATE by the amount entered for ADJUST RATE. This allows the operator to make changes to the TARGET RATE quickly. To disable this feature, simply enter "0" for a value.

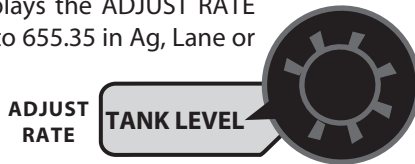

TARGET RATE: Selecting TARGET RATE (in English) displays the desired application rate in Gallons/Lane Mile for LANE mode, Gallons/Acre for AG mode, Gallons/Yard² for DUST mode and Gallons/Turf (1000 Feet²) for TURF mode. Selecting TARGET RATE (in Metric) displays the desired application rate in Liters/Lane Km for LANE mode, Liters/Hectare for AG Mode and Liters/Meters² for DUST mode. TURF mode does not apply to Metric settings. This is the application rate that the console will lock onto when operating in AUTO. After the Auto Delay time and Start time have been completed the Warning LED will flash and Audible Alarm will sound if enabled whenever the actual application rate is more than 10% from TARGET RATE.

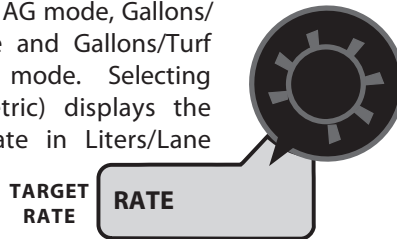

CAUTION: If spray lines are pressurized, nozzles may spray during WIDTH calibration (below).

NOTE: When in Lane Mode, a Lane Mile/kilometer is defined as the area in a swath equal to the Center (Primary) Section in width and one (1) mile/km long. The user defines a Lane Mile/kilometer by changing the Center Section width. For example, if the Center (Primary) Section Width is set to 12 feet, and the Left and Right Booms are set to three feet, one mile traveled will result in an Area of 1.5 Lane Miles covered.

WIDTH CAL: Displays the Section WIDTH from 0 to 65,535 inches or 0.000 to 65.535 meters for that section (Unused sections must be set to zero). The total width (sum of all Section widths) must not exceed 65,535 inches or 65.535 meters. To adjust a particular Section, turn that section switch on and all others OFF. If no Sections are turned on the display will read "no boom".

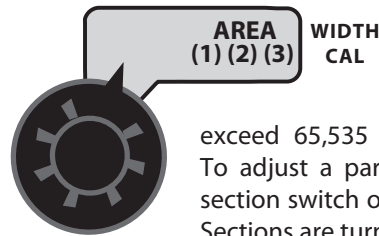

NOTE: The system must be in RUN mode to display section numbers. Repeat this procedure for each section. Enter a value of "0" (.000) for any unused sections. Your "working" width per section will be the number of nozzles on the section times the nozzle spacing in inches (meters). For example, if you have 7 nozzles spaced at 20 inches, the working width of th section is 140 inches.

NOTE: Most ROADMASTER™ PWM consoles are equipped with 3 Section switches. In Lane Mode, the CENTER Section switch is always the PRIMARY Section and is used to define the "LANE WIDTH". Ag, Dust or Turf Modes can use any Section switch. If the operator is only using ONE section it must be the Primary.

Calibration (cont)

Entering Calibration Values (cont)

SPEED CAL: This position is used to calibrate the speed sensor for accurate speed and distance measurement.

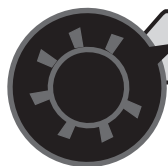

When this position is selected, the display will show the SPEED CAL value along with "CAL" on the display. In English units, the SPEED CAL number is displayed in inches, in metric it is displayed in centimeters. The SPEED CAL is factory-calibrated for use with an Astro GPS Speed Sensor. See the table below for SPEED CAL numbers for other types of GPS speed sensor or radars. *See Appendix B for procedure to calibrate if using a Magnetic Speed Sensor. See Appendix C for Fine-Tuning Speed Calibration.*

Radar or GPS Speed Sensor Calibration

Radars	English	Metric
Vansco	.150	.38
Raven	.148	.38
Magnavox	.154	.39
Dickey-john (Radar Velocity Sensor II)	.149	.38
	.199	.50
	.319	.81
	.518	1.32
GPS Speed	English	Metric
Astro II & 5	.189	.48
SkyTrak	.150	.38
Dickey-john	.210	.53
John Deere (In-Cab Speed Signal)	.197	.50

Default Calibration Values

Cal Factor	English	Metric
Mode	Lane	Lane
Speed Cal	.189	.48
Flow Cal	145.0	145.0
Min Flow	0.0 (Off)	0.0 (Off)
Target Rate	20.0 Gal/Lane Mile	45.0 liters/Ln km
Adjust Rate	1.0 Gal/Lane Mile	1.0 liters/Ln km
Boom 1 Width	0	0
Boom 2 Width	96 in	2.438 meters
Boom 3 Width	0	0

MODE SELECT: This position allows the user to change the MODE. Pressing the "+" or "-" (reset) will toggle between Lane, Ag, Dust and Turf (except in Metric) MODE and the display will show LANe, Ag, dUSt and turF.



MODE (ALARM RESET) MODE SELECT

EXPLANATIONS OF LANE, AG, DUST AND TURF MODES

The differences are primarily the UNITS used for AREA and DISTANCE.

LANE: Used for Highway Maintenance Applications where Area is accumulated in Units of Lane Miles (Lane Km). Distance is in Units of Miles (Km) and Application Rate is in amount of liquid per Lane Mile (Lane Km).

AGRICULTURAL: Mainly used for roadside spraying, where Area is in acres (hectares), Distance is in feet (meters) and Application Rates are in Gallons/Acre (liters/meter²).

DUST CONTROL: Used for controlling air borne particulates, where Area is in square yards (square meters), Distance is in yards (meters) and Application Rates are in Gallons/Yard² (liters/meter²).

TURF (English Only): Where Area is in 1000 square feet, Distance is in feet and Application Rates are in Gallons/1000 feet².

NOTE: A Mode change CLEARS the counters if Calibration is exited correctly. If power to the console is turned off before exiting Calibration, the counters are NOT cleared.

TEST SPEED: Enter the value to be used for simulating speed for performing Pre-application System checkout. The console will use this speed for simulating spraying operations. The test speed value is only used while in calibration mode. Once CAL is exited, the Test Speed value is reset to zero. **DO NOT ENTER A TEST SPEED UNTIL ALL OTHER VALUES ARE PROPERLY ADJUSTED.** Please refer to Pre-application System Checkout for details.

EXITING CALIBRATION: Upon completion of the calibration process, exit calibration. Basic calibration is now complete. Please refer to Pre-application System Checkout section to confirm overall system performance.

Calibration Log Sheet

Serial No. _____

Min Flow: _____

Adjust Rate: _____

Target Rate: _____

Width Cal (Section Width):	<u>left</u>	<u>center</u>	<u>right</u>
	_____	_____	_____
	_____	_____	_____
	_____	_____	_____

Speed Cal: _____

Mode Sel: _____

Test Speed: _____

Comments: _____

“Special” Calibration

Entering Calibration Values

NOTE: UNITS (English or Metric) must be set in “Special” Calibrate before any other CALIBRATE or “SPECIAL” CALIBRATE values.

There are three (3) pages of “SPECIAL” CALIBRATE values, total of 23 used for PWM Drive, selected by the rotary switch and BLAST key. To enter Special Cal, put the system in HOLD, turn the console power OFF, press and hold both the AUTO/MAN button and BLAST button while turning console ON. The console will display SPEC for 2 seconds to show that the console is in the Special Calibration mode. Release the AUTO/MAN and BLAST buttons.

If the Console is unlocked, the Warning LED will also turn on and any of the “Special” CALIBRATE values can be adjusted.

If the Console is locked, the Warning LED will not turn on and the “Special” CALIBRATE values can only be viewed and cannot be adjusted.

NOTE: Press the BLAST key to alternate between SPECIAL CAL pages 1, 2, and 3 (Number icons indicate page).

The desired Special Calibration Parameter(s) can then be accessed with the rotary switch. To exit Special Calibration, press and hold the BLAST button for 1 second. The console will save any changes and revert to normal operation.

To exit without saving changes, simply turn the console power off without pressing BLAST.

Pulse Width Modulation (PWM) Special Calibrate

Special Cal Page 3	Special Cal Page 2	Special Cal Page 1
Manual Enable	Minimum Alarm Speed	Fill Tank Size
Flow @ Min PWM	Start Time	Tank Alarm Set Point
Min PWM	Valve Start Percentage	Blast Duration
Alarm Enable	Auto Delay Time	Blast Target Rate

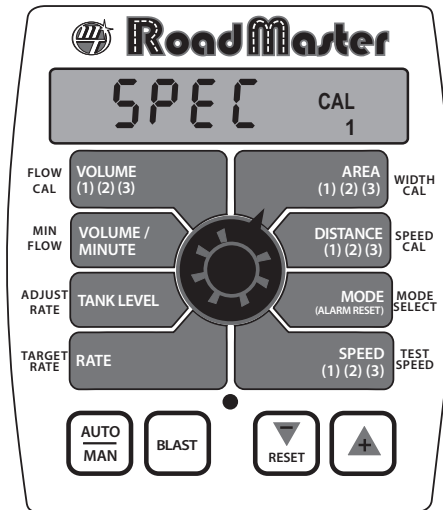

Special Cal Page 1	Special Cal Page 2	Special Cal Page 3
Units (Eng/Metric)	Set Year	PWM Freq.
Vehicle Number	Set Month	Flow @ Max PWM
Agitation Percentage	Set Date	Max PWM
Valve Speed	Set Time	Closed/Open Loop

Default “Special” Calibration Values

“Special” Calibration Factor	English	Metric
Tank Set Point	Off	Off
Fill Tank Size	Off	Off
Control Speed	-1	-1
PWM Frequency	200 Hz	200 HZ
Min PWM	30%	30%
Max PWM	90%	90%
Flow @ Min PWM	.00	.00
Flow @ Max PWM	.00	.00
Vehicle Number	1	1
Blast Target Rate	30 Gal/Lane Mile	65 liters/Lane km

“Special” Calibration Factor	English	Metric
Blast Duration	15 Sec	15 Sec
Valve Start Percentage	10	10
Start Time	0 (Off)	0 (Off)
Auto Delay Time	1 sec.	1 sec.
Auto Shut-Off	Off	Off
Closed/Open Loop	Closed Loop	Closed Loop
Minimum Alarm Speed	0 mph	0 kph
Manual Control Enable	On	On
Alarm Enable	On	On

“Special” Calibration (cont)

Entering Calibration Values (cont)

Page One

FILL TANK SIZE: Selecting the VOLUME position on page one (1) allows the user to enter a FILL TANK SIZE which can be toggled to OFF or 1 to 65535 using the “+” or “-” (reset) keys. The FILL TANK SIZE is in gallons in English or liters if in Metric Units. If a FILL TANK SIZE is specified, then pressing “+” while set to the **TANK** position (in Operation) will set the TANK value to FILL TANK SIZE for quick reloading.

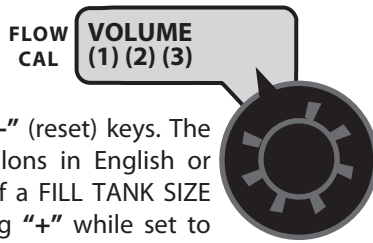

TANK ALARM SET POINT: Selecting the VOLUME/MINUTE position on page one (1) allows a TANK ALARM SET POINT to be entered. When “Off” no alarm sounds when the tank is emptied. If set to any other value, the Warning LED will flash, the alarm will sound and the display will alternate between FILL and normal when Tank value falls below the Set Point.



BLAST DURATION: Selecting the TANK LEVEL position on page one (1) allows the user to enter the desired BLAST DURATION. It can be adjusted from 0 (Off) to 255 seconds.



BLAST TARGET RATE: Selecting the RATE position on page one (1) allows the user to enter the desired BLAST TARGET RATE. The units and range are identical to the normal TARGET RATE but BLAST TARGET RATE is only used when the **BLAST** key is pressed.

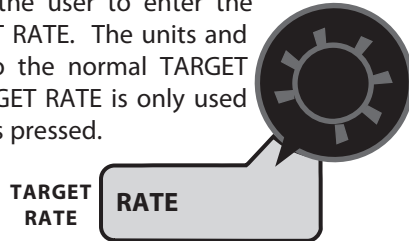

UNITS (English or Metric): NOTE: Changing UNITS will load defaults, so they should always be changed first and then all other CALIBRATE and “SPECIAL” CALIBRATE values may be set.

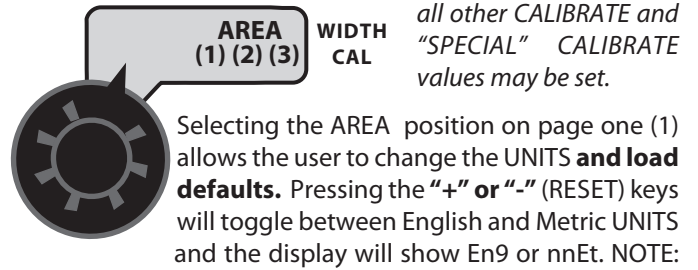

Selecting the AREA position on page one (1) allows the user to change the UNITS and load defaults. Pressing the “+” or “-” (RESET) keys will toggle between English and Metric UNITS and the display will show En9 or nnEt. NOTE: Trying to select Metric Units in Turf Mode will cause the Error message to be displayed. Defaults will not be loaded until the Rotary Selector is moved away from AREA or the “Special” Cal page is changed or “Special” Cal is exited normally.

VEHICLE NUMBER: Selecting the DISTANCE position on page one (1) allows the user to change the VEHICLE NUMBER from 0 to 255 by using the “+” or “-” (Reset) keys. The VEHICLE NUMBER is downloaded with the Total and Configuration data through the serial port.

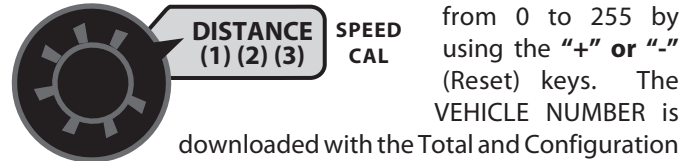

AGITATION PERCENTAGE: Enables Tank Agitation when system is in Hold, and adjusts the desired duty cycle for the agitation. This can be set to OFF (0) or from 1 to 100%. Agitation is disabled during any calibration mode.

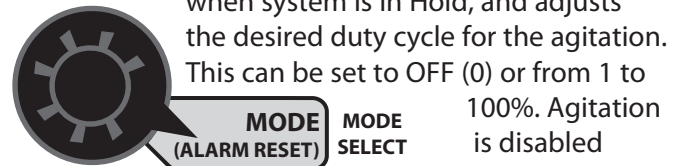

VALVE SPEED: Selecting the SPEED position on page one (1) allows VALVE SPEED to be changed, to adjust system response speed (if required). Pressing the “+” or “-” (Reset) keys will adjust the VALVE SPEED from -4 to 3. Normal setting is -1. NOTE: Use caution when adjusting the Valve Speed setting. Higher values used with a fast valve may cause system instability (hunting, oscillations).

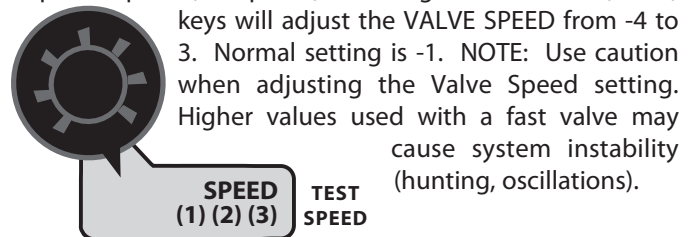

“Special” Calibration (cont)

Entering Calibration Values (cont)

Page Two

ALARM MINIMUM SPEED: Selecting the VOLUME position on page two (2) allows adjustment of the ALARM MINIMUM SPEED. Pressing the “+” or “-” (Reset) keys will adjust the ALARM MINIMUM SPEED from 0.1 to 99.9 mph or kph. When the ground speed is below the ALARM MINIMUM SPEED, an Application Rate error will not generate an Audible Alarm. Tank empty and Float alarms are not disabled. Setting the ALARM MINIMUM SPEED to Off will disable the function and allow audible warnings at any speed. This setting can be used to disable nuisance alarms while stopping and starting.

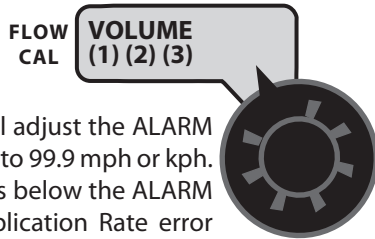

START TIME: Selecting the VOLUME/MINUTE position on page two (2) allows the user to change the START TIME for the control valve. The START TIME can be adjusted from Off to 2.048 seconds. The START TIME runs the Control Valve at Valve Start Percentage (see below) for the amount of time (seconds) set, when a HOLD to RUN transition occurs. The control valve is used to stop hydraulic flow and can be the cause of an undesirable delay for the Servo to return to normal operating flow. The START TIME cal value can be used to reduce this delay.



VALVE START PERCENTAGE: Selecting the TANK LEVEL position on page two (2) allows the user to change the VALVE START PERCENTAGE for PWM drive systems. The Control Valve is used to completely stop the hydraulic flow when HOLD is selected, all non-zero Booms are off or if ground speed is zero in AUTO. There may be an undesirable delay for the valve to open back up and return to normal operating flow. The VALVE START PERCENTAGE factor can be used to reduce this delay and help make the system reach the Target Application Rate sooner (*when in AUTO*). VALVE START PERCENTAGE can be set to Off or adjusted from 1 to 50%. The VALVE START PERCENTAGE of the PWM duty cycle will be set for a change from HOLD to RUN and some Booms on and travel of about 10 inches or a change from all non-zero Booms off to some Booms on and in Run and travel of about 10 inches. The PWM valve will remain at this duty cycle for the duration of START TIME. If either the VALVE START PERCENTAGE or START TIME (Quick Start) is set to OFF then this feature is disabled.



AUTO DELAY TIME: Selecting the RATE position on page two (2) allows the user to change the AUTO DELAY TIME from 0 (no delay) to 1, 2, 3 or 4 seconds by using the adjustment of the “+” or “-” (Reset) keys. Automatic control is delayed for AUTO DELAY TIME seconds when going from Hold to Run or from all nonzero Booms off to one or more Booms on. This provides time for motorized Boom valves to operate and allows the flow to stabilize before AUTO control begins.

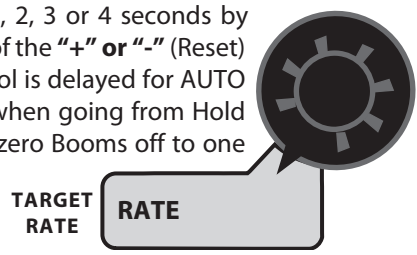

SET YEAR: Selecting the AREA position on page two (2) allows the YEAR to be set from 07 to 99 for 2007 to 2099 using the “+” or “-” (Reset) keys.

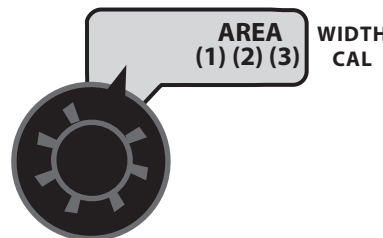

SET MONTH: Selecting the DISTANCE position on page two (2) allows the MONTH to be set from 01 to 12 (Jan to Dec) using the “+” or “-” (Reset) keys.

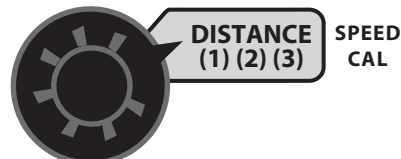

SET DATE: Selecting the MODE position on page two (2) allows the DATE to be set from 01 to 31 by adjusting the “+” or “-” (Reset) keys.

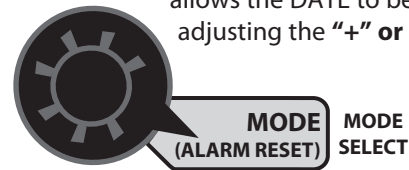

SET TIME: Selecting the SPEED position on page two (2) allows the user to change the TIME from 00:00 to 23:59 by using the “+” or “-” (Reset) keys. The LCD does not include a colon so a decimal point is used.

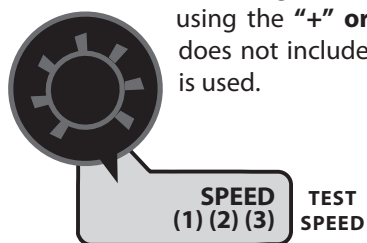

“Special” Calibration (cont)

Entering Calibration Values (cont)

Page Three

MANUAL ENABLE: Selecting the VOLUME position on page three (3) allows the user to turn the MANUAL CONTROL ENABLE On or Off by using of the “+” or “-” (Reset) keys. Setting to Off disables Manual Control. Pressing the AUTO/MANUAL key will not toggle between Auto and Manual when set to on.

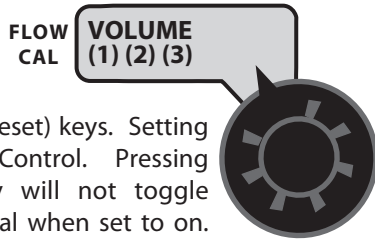

FLOW AT MINIMUM PWM: Selecting the VOLUME/MINUTE position on page 3 will display and allow adjustment of the FLOW @ MIN PWM from 0.0 to 655.35 Gallons/minute (liters/minute). The PWM Valve can only be mounted InLine so FLOW @ MIN PWM must be smaller the FLOW @ MAX PWM or auto control will fail. If in AUTO and FLOW @ MIN PWM is equal to or greater than the FLOW @ MAX PWM then it will display **Error**. FLOW @ MIN PWM is the Volume/Minute applied when the PWM control valve is operating at MIN PWM duty cycle independent of the number of Booms turned on (*due to positive displacement pump*). When some Booms are turned Off, it is assumed pressure will increase but the flow will remain equal to FLOW @ MIN PWM due to the positive pump displacement. When using Open Loop (*or Closed Loop override*) in AUTO control, the control algorithm uses FLOW @ MAX PWM and FLOW @ MIN PWM to determine the PWM duty cycle needed to achieve the desired Application Rate. A value of zero will allow Open Loop (*or Closed Loop override*) operation in AUTO or MANUAL if FLOW @ MAX PWM is valid (> zero).

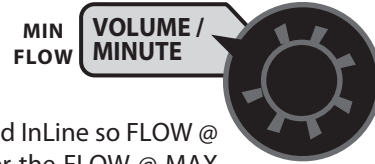

MINIMUM PWM DUTY CYCLE: Selecting the TANK LEVEL position on page 3 will display the MIN PWM duty cycle. It can be adjusted from 0% to 100% in 1% steps. The PWM duty cycle will remain at or above this limit in both MANUAL and AUTO operations, when in RUN. For proper operation it must be set to some value less than the MAX PWM duty cycle. The MIN PWM function can be used to ensure the hydraulic flow never drops below a set amount. This could be used to make sure a hydraulic motor never stops turning or application pressure does not go below the minimum rating for the nozzles being used. It can also be used to optimize operation with a particular PWM Valve and set of nozzles.



ALARM ENABLE: Selecting the RATE position on page three (3) allows the user to turn the audible ALARM ENABLE On or Off by using the adjustment of the “+” or “-” (Reset) keys. Setting ALARM ENABLE to Off will disable all audible Alarms under all conditions.

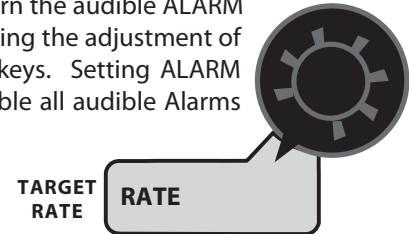

PWM FREQUENCY: Selecting the AREA position on page 3 will display the PWM FREQUENCY. It can be adjusted from 50 Hz to 500 Hz in 1 Hz steps and should be set to the optimum frequency for the particular PWM Valve being used.

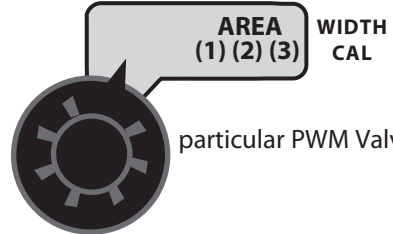

FLOW @ MAXIMUM PWM: Selecting the DISTANCE position on page 3 will display and allow adjustment of the FLOW @ MAX PWM from 0.0 to 655.35 Gallons/minute (liters/minute). The PWM Valve can only be mounted InLine so FLOW @ MAX PWM must be larger than FLOW @ MIN PWM or auto control will fail. If in AUTO and FLOW @ MAX PWM is equal to or less than FLOW @ MIN PWM then it will display **Error**. FLOW @ MAX PWM is the Volume/Minute applied when the PWM control valve is operating at MAX PWM duty cycle independent of the number of Booms turned on (*due to positive displacement pump*). When some Booms are turned Off, it is assumed pressure will increase but the flow will remain equal to FLOW @ MAX PWM due to the positive pump displacement. When using Open Loop (*or Closed Loop override*) in AUTO control, the control algorithm uses FLOW @ MAX PWM and FLOW @ MIN PWM to determine the PWM duty cycle needed to achieve the desired Application Rate. In MANUAL or AUTO operation, when using Open Loop (*or Closed Loop override*), Volume/Minute and Rate will be calculated and displayed, the Tank and Volume applied counters will be adjusted and the Application Rate and Tank Level errors will be issued based on the straight line flow rate from FLOW @ MIN PWM to FLOW @ MAX PWM corresponding to the PWM duty cycle output. A FLOW @ MAX PWM value of zero will disable Open Loop (*or Closed Loop override*) operation in AUTO. If the user tries to change the CLOSED/OPEN LOOP Cal factor it will display **Error** instead of OPEN if FLOW @ MAX PWM is still zero, and the BLAST key will not select the ‘Closed Loop Override’ when **EStoP** is displayed. With a FLOW @ MAX PWM value of zero (*Open Loop disabled*), MANUAL will still change PWM valve from MIN PWM to MAX PWM, but Volume/Minute and Rate will only display .00, the Tank and Volume applied counters will not be adjusted and the Application Rate and Tank Level errors will be disabled.



“Special” Calibration (cont)

Entering Calibration Values (cont)

Page Three (cont)

MAXIMUM PWM DUTY CYCLE: Selecting the MODE position on page 3 will display the MAX PWM duty cycle. It can be adjusted from 0% to 100% in 1% steps. The PWM duty cycle will remain at or below this limit in both MANUAL and AUTO operations, when in RUN.



MODE
(ALARM RESET) **MODE**
SELECT

For proper operation it must be set to some value greater than the MIN PWM duty cycle. The MAX PWM setting can be used

to ensure the hydraulic flow never exceeds the maximum amount. This could be used to make sure a hydraulic motor never exceeds a maximum RPM or application pressure does not exceed a maximum rating for the nozzles being used. It can also be used to optimize operation with a particular PWM Valve and set of nozzles.

CLOSED/OPEN LOOP: Selecting the SPEED position on page 3 allows the selection of CLOSED LOOP or OPEN LOOP operations. Pressing the “+” or “-” (Reset) keys will toggle



SPEED
(1) (2) (3) **TEST**
SPEED

the display between **CLOSE** for Closed Loop and **OPEn** for Open Loop. Closed Loop operation uses feedback from a flow meter or motor RPM sensor and FLOW CAL to calculate and adjust the Application Rate based on ground speed. Open Loop (or Closed Loop

override) operation used an estimated flow rate (FLOW @ MIN PWM, FLOW @ MAX PWM) based on the PWM duty cycle (MIN PWM, MAX PWM) to adjust the application rate based on ground speed. Open Loop cannot be selected unless FLOW @ MAX PWM has already been set to some value greater than zero. It will display **Error** instead of **OPEn** if FLOW @ MAX PWM is still zero.

Operation

Console Switches and Buttons

Make sure your system is properly calibrated before beginning to apply product. *We also recommend completion of the Pre Application System Checkout described on page 26 prior to beginning any operations.*

The ROADMASTER PWM system can be operated in either Manual or Automatic mode. In manual mode, the application rates (*See page 24 for different rates*) are set using the “+” and “-” buttons; the application rate will vary depending on the vehicle speed. The manual mode is useful for system set up, spot applications, etc.

To turn on the AUTO mode, press AUTO/MAN button so the AUTO icon appears in upper right portion of display. In automatic mode, the system will control the flow rate to maintain the calibrated application rates (*See table on page 25 for different rates*) when the vehicle speed changes, or sections are turned on or off. To operate the system in automatic mode, simply turn on the desired number of sections, place the RUN/HOLD switch in the RUN position and drive. **NOTE: In AUTO mode, the system will not turn the sections on until it has a speed signal.** Use the Section switches, the RUN/HOLD switch or the remote RUN/HOLD sensor to Start or Stop application at any time. See the following sections for operation details.

CONSOLE POWER/SYSTEM ON/OFF

When the ROADMASTER PWM Console is turned on, except when starting “SPECIAL” CALIBRATE, the data display will show the Number of Hours it has operated for one (1) second, the Software Part Number (45022) and Software Revision for 1.5 seconds each. Then it will display PULSE for 1.5 seconds showing that this is a PWM Drive Console.

DISPLAY

During normal operation, the console will display information selected by the rotary switch position. Typically the rotary switch will be set on RATE, as shown in *Illustration 8*. With RATE selected, the console will display the Application Rate based on the Mode and Units selected.

RUN/HOLD SWITCH

The RUN/HOLD is the master switch for turning all (active) sections on and off. This function can be done either manually with the included RUN/HOLD switch, or automatically, using the optional RUN/HOLD sensor kit.

AUTO/MAN BUTTON

This button will switch the control status of the system from fully automatic to manual control. Each press of the button will change the status. The display will show the AUTO icon when automatic control mode is active and the MAN icon when manual control mode is active. **NOTE: IF IN “AUTO” MODE AND NO SPEED SIGNAL IS PRESENT, SYSTEM WILL SHUT OFF THE SECTIONS AUTOMATICALLY.**

Illustration 8

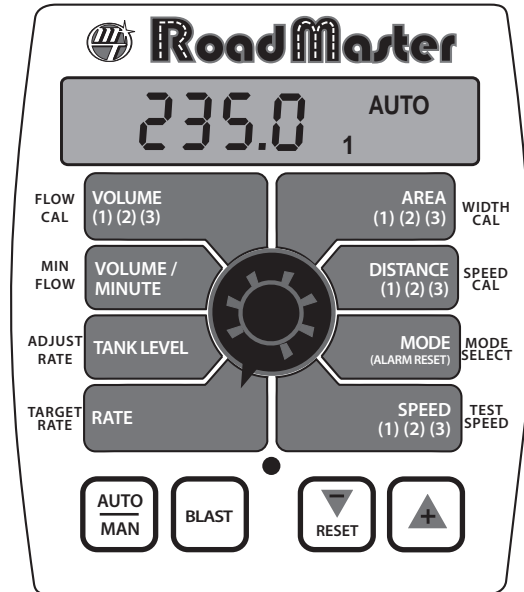

BLAST BUTTON

The BLAST function is intended for spot applications (bridge decks, intersections) at a higher rate. The BLAST calibration functions include BLAST TARGET RATE and BLAST DURATION. When the user presses the **BLAST** switch in Auto, the system will display **BLAST** and output the preset rate for a preset period. The period starts when the BLAST switch is released. If the BLAST switch is pressed again during the reset period, BLAST will be cancelled. When the BLAST is complete, the system returns to normal operations. BLAST will **NOT** function in Manual mode or if the system is in HOLD or stopped.

“+” AND “-” BUTTONS

During normal operation, when automatic “AUTO” control mode is active and the rotary dial is set to RATE, each press of the “+” or “-” buttons will increase or decrease the target application rate by the amount of the calibrated Adjust Rate.

During normal operation, when manual “MAN” control mode is active and the Run/Hold switch is in the RUN position, and Rotary dial is set to RATE or VOLUME/MINUTE, pressing the “+” or “-” buttons will increase or decrease the application rate.

Operation (cont)

Console Switches and Buttons (cont)

SECTION SWITCHES

The system monitors the status of the section switches to determine whether they are ON or OFF. The console accumulates area based on the calibrated sections widths. When an individual section is turned OFF, the respective width is subtracted from the total width to accumulate area based on the new active application width. If the rotary switch is in the RATE position, the numbers 1, 2, 3, 4 or 5 on the display will light when their respective section is ON.

NOTE: ROADMASTER consoles are equipped with 3 section switches. In Lane Mode, the CENTER section switch is always the PRIMARY section and is used to define the "LANE WIDTH". Ag, Dust or Turf Modes can use any section switch. If the operator is only using ONE section it must be the Primary.

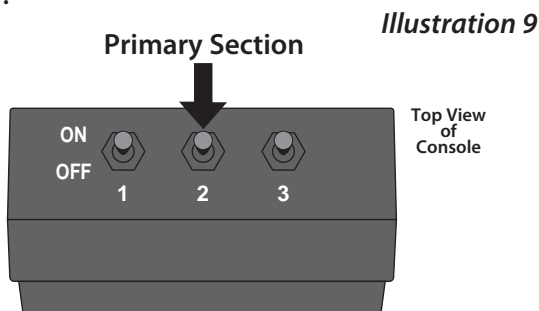

WARNING DEVICE

The console is equipped with a RED warning light. The light will automatically turn on and flash when the actual application is plus or minus 10 percent of the calibrated target rate, or if the TANK alarm feature is activated and the tank is below the set point (display will also flash "FILL" message). If the light stays on while in AUTO, refer to the troubleshooting section of this manual. The RED warning light will also be illuminated when calibration mode is active on the console.

AUDIBLE ALARM

The Audible Alarm is activated for the following conditions:

- The calculated Tank level is below minimum level (TANK ALARM SET POINT).
- Float switch is continuously active for 15 seconds or more.
- The Application Rate Error is greater than 10% for 3 seconds (continuously) after the Auto Delay and Start Up time have completed and the console is in AUTO, and the Ground Speed is above the Alarm Minimum Speed.

ROTARY SWITCH

During normal operation, you can view any one of eight monitored functions by turning the rotary switch to the appropriate position. The functions that are active during normal operation are the BLUE boxes. Calibration positions are identified by the WHITE labeling on each side of the rotary selector (*please refer to Calibration section for details*).

EMERGENCY STOP

When in AUTO and in RUN with one or more Booms on and the Speed is greater than zero, if the Flow signal ever stops, the servo will run to fully open. If Flow remains stopped for 5 seconds or more, it will automatically stop the hydraulic flow to prevent damage to the pump. "EStOP" will then display to notify the user of the Emergency Stop. The flow remains off and AUTO control will remain disabled until the system goes into HOLD, power is cycled or CALIBRATE is entered. The Emergency Stop feature helps protect against "chemical spills" or over-application if the Flow signal is lost.

If the Flow Signal cannot be restored, Closed Loop Override can be selected by pressing BLAST until "EStOP" is cleared. Closed Loop Override will stay in effect until power is removed or CALIBRATE is entered.

Closed Loop Override allows the operator to continue without Flow input. It operates exactly as if Open Loop was selected in "Special" Cal, but is active only temporarily.

SERIAL PORT

The DB-9 connector on the back of the console provides access for Serial Communication to/from the console. The Serial Configuration is RS-232, 9600 baud, in 8-N-1 half-duplex format. Data is sent and received in comma-delimited ASCII format. An external device (GPS/Mapping/AVL System) can change the application rate on-the-go and also receives and records data from the ROADMASTER PWM. *See Appendix H and I for data lists available.*

Rotary Positions

NOTE: VOLUME, AREA, DISTANCE & SPEED counters work in sets, if the VOLUME counter 1 is reset, it also resets AREA counter 1, DISTANCE counter 1 and SPEED counter 1. This will be the same for resetting any counters in the set. DO NOT use the "-" button to select counters because the button will clear them. (*See Resetting System Counters on page 26*). This active set of counters may be reset to zero independent of the other sets of system counters.

VOLUME

Displays the total gallons (liters) applied since the active counter was last reset to zero based on the UNITS Selected. Number Icons indicate which set of counters is being displayed. Press the "+" button to select other counter sets.

VOLUME/MINUTE

Displays the gallons (liters) per minute being applied.

TANK LEVEL

Displays amount remaining in the tank. When the tank is refilled, and the tank volume has been entered in Calibration, the TANK LEVEL amount can be reset to a full tank by simply pressing the "+" button for 1 second while the rotary switch is in the TANK level position. The amount in the tank can be decreased by using the "-" button but cannot be increased above the FILL size. If no FILL TANK SIZE is specified, the "+" or "-" (Reset) keys can be used to adjust Tank to any value. The Tank value cannot be changed while in CALIBRATE or "SPECIAL" CALIBRATE mode except it can be changed while TEST SPEED is set.

Operation (cont)

Rotary Switches (cont)

RATE

Displays the Application Rate based on the selected MODE (See Table below).

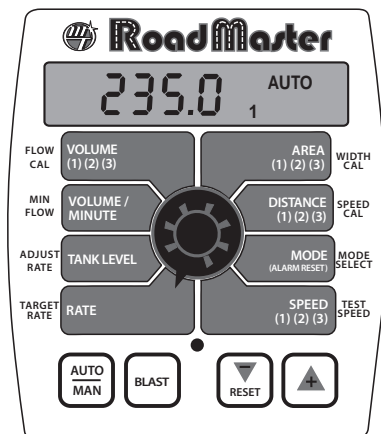

Mode	English	Metric
Lane	Gallons/Lane Mile	liters/Lane km
Ag	Gallons/Acre	liters/hectares
Dust	Gallons/Yards ²	liters/meters ²
Turf	Gallons/Turf	n/a

AREA

Displays the area covered since the counter was last reset to zero based on the MODE selected. The area counters do not accumulate area when the console is in HOLD or if all booms are turned OFF. Number Icons indicate which set of counters is being displayed. Press the "+" button to select other counter sets.

Mode	English	Metric
Lane	Lane Miles	Lane km
Ag	Acres	hectares
Dust	Yards ²	meters ²
Turf	1000 Feet ² (Turf)	n/a

AREA is displayed in the following units based on UNITS and MODE

DISTANCE

Displays the distance driven since the counter was last reset to zero based on the MODE Selected. This counter does not accumulate when the console is in HOLD or all Booms are off. Number Icons indicate which set of counters is being displayed. Press the "+" button to select other counter sets.

Mode	English	Metric
Lane	Miles	Kilometers
Ag	Feet	Meters
Dust	Yards	Meters
Turf	Feet	n/a

DISTANCE traveled is displayed in the following units based on UNITS and MODE

MODE

Displays Current Mode (Lane, Ag, Dust and Turf). **NOTE: Turf mode is not available in Metric Units.**

UNLOAD

In the PWM drive version (only) the Unload function is used to transfer material from the applicator to storage. It is a special function which allows the PWM valve (and pump) to be run without turning any boom switches on.

To start the Unload function, the console must be in the **MODE** position, the applicator must be stopped (**ground speed = 0**), all nonzero boom switches turned **OFF** and in **HOLD** and **NOT** in **CALIBRATE** or **"SPECIAL" CALIBRATE**. Pressing and holding the **AUTO/MAN** switch for 3 seconds starts the function and displays **UnLd** in all rotary positions and selects **Manual** control, but the **MAN** and **AUTO** icons remain **OFF**. The **VOLUME**, **TANK LEVEL**, **DISTANCE** and **AREA** counters are disabled (will not change), and can not be cleared, while the Unload function is active. While displaying **UnLd** all number icons will remain off in all rotary positions.

Setting the RoadMaster to **RUN** will start the valve at Minimum PWM Duty Cycle, even if all nonzero boom switches are turned off. The Duty Cycle can then be adjusted up and down between the **MINIMUM** and **MAXIMUM PWM DUTY CYCLE** settings using the "+" / "-" (**RESET**) switches and the valve can be stopped and started by switching between **RUN** and **HOLD**. While displaying **UnLd** the **AUTO/MAN** switch will no longer select Automatic control and the **MAN** and **AUTO** icons will remain off.

To prevent chemical spills, or waste, the Booms are always disabled while the Unload function is active in case the user accidentally turns a Boom on (*see Boom Switches on previous page*).

Exit the Unload function by pressing and holding the **AUTO /MAN** switch for 3 seconds while in any rotary position. The display and console will return to normal operation.

NOTE: Set plumbing as required by Sprayer Manufacturer.

SPEED

Displays the ground speed in miles (kilometers) per hour. When the operator selects **SPEED**, the Current Velocity will be computed and displayed in 0.1 increments from 0 to 999.9 mph or kph. In the **SPEED** position, the Number Icons indicate which data set is selected and changes each time the "+" button is pressed. If the user presses the "-" (**RESET**) key the display will change from Current Velocity to display the Average Velocity (for the selected data set) for 2 seconds. The display will then display the Highest Velocity for 2 seconds and return to display Current Velocity. The Left most digit will display "A" for Average and "H" for Highest when the average and highest speed is being displayed. Speed will continue to operate while in **HOLD** or all nonzero Booms are off, if a speed signal is still present. Average and Highest **WILL NOT** be changed while in **HOLD**. The illustration to the right shows the Speed in Data Set 1 and the "-" (**RESET**) key has been pressed to show the Highest (H) speed.

Resetting System Counters

The VOLUME, AREA, DISTANCE & SPEED data counters maintain a running count during operation regardless of the position of the rotary switch. When any of these counters reach their maximum capacity, or when you want to start a new count, the value may be reset to zero by performing the following routine. Counter sets may be reset independently of each other. NOTE: If the console is locked, only Data Set 1 can be cleared.

1. Turn the booms OFF or put the system in HOLD.
2. Turn the rotary switch to Volume, Area or Distance.
3. There are three independent VOLUME counters, paired with three AREA counters, paired with three DISTANCE counters and with three SPEED Values (Average and Highest velocity). The active set of counters is indicated by the small numbers in the lower right area of the display (1, 2, or 3) when the rotary switch is in the VOLUME, AREA or DISTANCE position. Select the set of counters you want to RESET by pressing the "+" button. The small number will increment each time the "+" button is pressed (from 1 to 3, then rolls back to 1). DO NOT attempt to select the counter number by using the "-" button, because that will clear the active set of counters if held for 2 seconds. If the "-" button is accidentally pressed, the console will display "CLEAR" to alert the user that the counters will be cleared. If the user continues to hold the "-" button for 2 seconds "CLEAR" will disappear and be replaced by 0.0, indicating that the selected set of counters has been cleared.

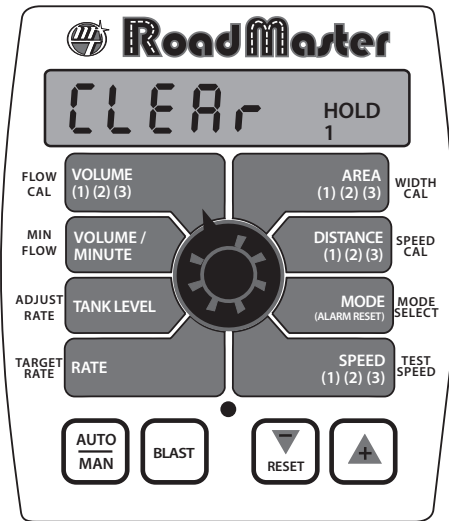

Display indicates that counter set #1 is selected

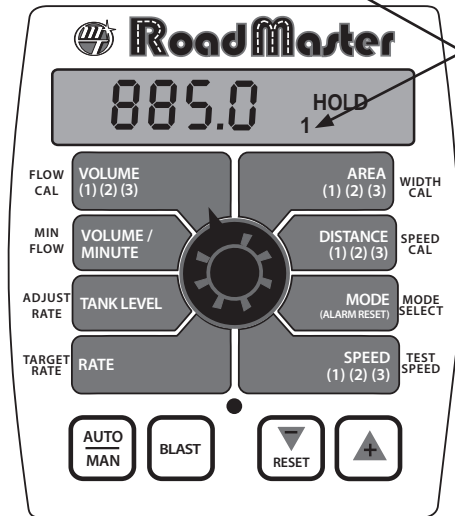

Display indicates that counter set #2 is selected

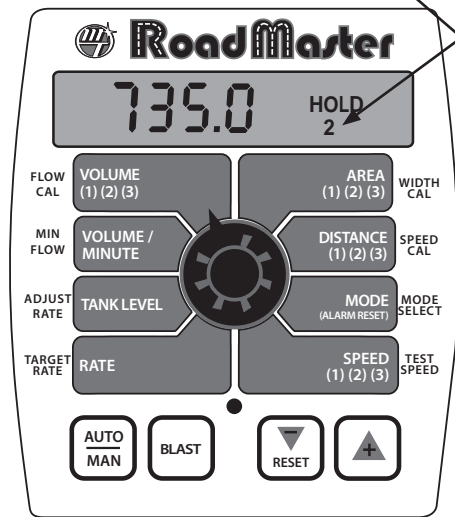

Display indicates that counter set #3 is selected

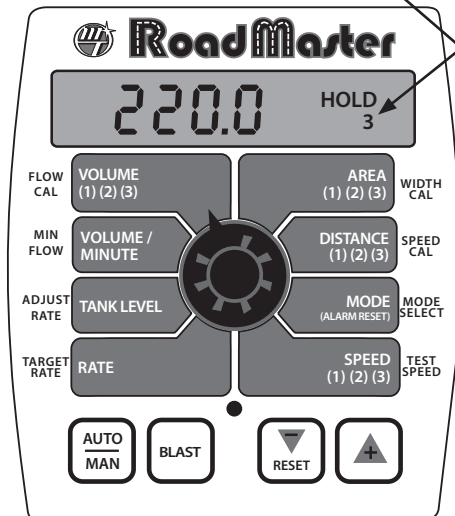

Pre-Application System Checkout

Before beginning actual application, perform the following "Pre-field" procedure to ensure that your valve settings, nozzle selection and desired speed range will allow the ROADMASTER PWM to provide the required application control. By performing all of the steps listed below, you set up your system to allow the ROADMASTER PWM to perform at optimum level. Fill your application tank with clean water. **DO NOT** use chemicals until the entire system is completely checked out and operating properly.

NOTE: Pre-field System Checkout is a procedure performed while the console is in the CAL mode. During the procedure, "CAL" on the display will be flashing.

1. Start vehicle and bring the engine up to normal operating RPM.
2. Enter MAXIMUM application TEST SPEED into console. With console in HOLD, enter calibration mode. Push and hold (BLAST) button. CAL will appear on display and red light will be on if unlocked. Turn rotary switch to TEST SPEED position. Use "+" or "-" button to enter maximum application speed. Do not exit calibration mode. CAL will flash indicating TEST SPEED mode.
3. Select manual "MAN" control mode, turn all active boom switches to ON position and put Run/Hold switch in RUN position. NOTE: even if no boom valves are being used, the primary boom should have the proper width entered, and it is used to turn the system on.
4. Turn Rotary switch to RATE position and hold "+" button to increase the RATE to maximum. The display should now read more than the maximum desired Application Rate.

Illustration 10

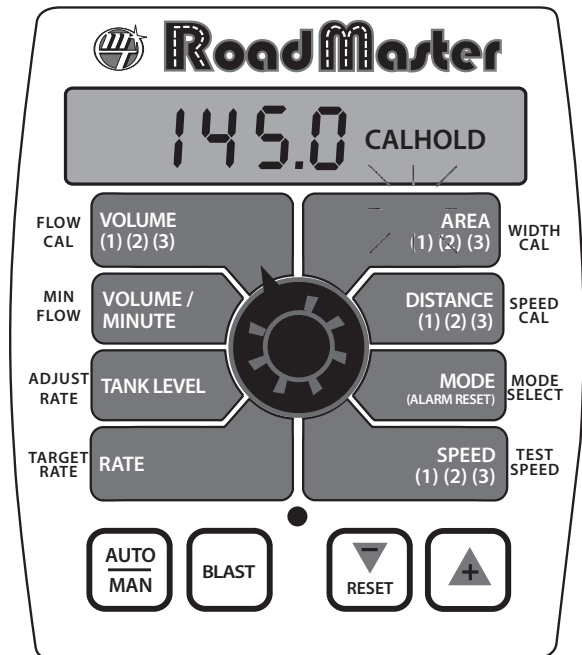

CAN'T GET THERE?

If you can't get to the desired application rate, you may need a different pump, or modifications to your plumbing configuration. Please refer to Troubleshooting Plumbing.

Now is a good time to confirm that RATE, VOLUME/MINUTE, MPH, WIDTH and PSI all coincide with the nozzle manufacturer's charts. PSI may be slightly higher than indicated by the charts due to pressure drop across the boom valves, nozzle diaphragm check valves, nozzle screens, etc.

Enter MINIMUM application TEST SPEED into console. Turn rotary switch to TEST SPEED position. Use the "+" or "-" (Reset) button to enter minimum application speed. Do not exit calibration mode. (Remember, the minimum application speed is not normally less than half of the maximum application speed.)

Put Run/Hold switch in RUN position (make certain system is in Manual mode), turn rotary switch to RATE position and hold "-" button to reduce the rate to minimum. The display should now read less than the minimum desired application rate.

CAN'T GET THERE?

If holding the "-" button does not get the application rate to go below the minimum desired application rate, please refer to Troubleshooting Plumbing.

Care and Maintenance of your ROADMASTER PWM Console

Store the console in a cool, dry location if it will not be used for an extended period of time, such as during the off-season.

As with any electronic equipment, use care in cleaning so that water or other liquids do not enter the case.

Thoroughly flush flowmeter with clean water, install plastic shipping plugs and keep from freezing.

Precautions

Do not expose the flowmeter to liquid temperatures exceeding 130 degrees F (55 degrees C).

Some chemicals may damage the noryl turbine or the body of the flowmeter.

If you are in doubt, contact the chemical manufacturer.

Pulse Width Modulation (PWM) Live Calibrate

LIVE CALIBRATE (PWM ONLY)

If the user already knows the FLOW @ MIN PWM, MIN PWM, FLOW @ MAX PWM and MAX PWM calibration factors then the user should use "Special" Calibrate to enter those values directly. However, if those factors are unknown the user can use the interactive LIVE CALIBRATE to determine the correct values for each.

In Closed Loop, LIVE CALIBRATE allows the user to adjust the MIN PWM or MAX PWM without the need to repeatedly enter or exit "Special" Calibrate.

In Open Loop, a flowmeter is not available to measure the flow so LIVE CALIBRATE provides a convenient 30 second timer and automatic shut off to make it easier to capture the flow in a calibrated container to manually determine the flow.

NOTE: The following applies to both Closed and Open Loop operation.

If the console is unlocked and in HOLD (or all non-zero section switches Off) and no ground speed is present, and not in CALIBRATE or "SPECIAL" CALIBRATE, then holding the "+" and "-" (Reset) button for 1 second will enter LIVE CALIBRATE and the V and CAL icons and the Warning LED will turn on.

Once LIVE CALIBRATE is started, it will remain in LIVE CALIBRATE regardless of Section Switch, Speed or Hold status.

LIVE CALIBRATE is exited and the factors saved by holding the "+" and "-" (Reset) button for 1 second regardless of Section Switch, Speed or Hold status.

Factors will NOT be saved if power is lost so unwanted changes can be discarded by removing power.

The display will show when in an unused position but the V and CAL icons will remain on.

PWM output drive will be set to MINIMUM PWM duty cycle when in the two MIN (left) positions and set to MAXIMUM PWM when in the two MAX (right) positions (*See Illustration 11*).

When in one of the four used positions, momentarily pressing the BLAST key will toggle the Pump on and off (at the selected MIN or MAX PWM rate).

The pump is off, in all unused positions, or if all non-zero width section switches are turned off. When all sections are turned off, the pump will be off but will resume when a section switch is turned on. However, if any unused position is selected then the pump is "toggled off" (as if the BLAST key was used) and it will stay off even when a used position is selected. Normally all non-zero width sections should be turned on, however, some special conditions may require

Illustration 11

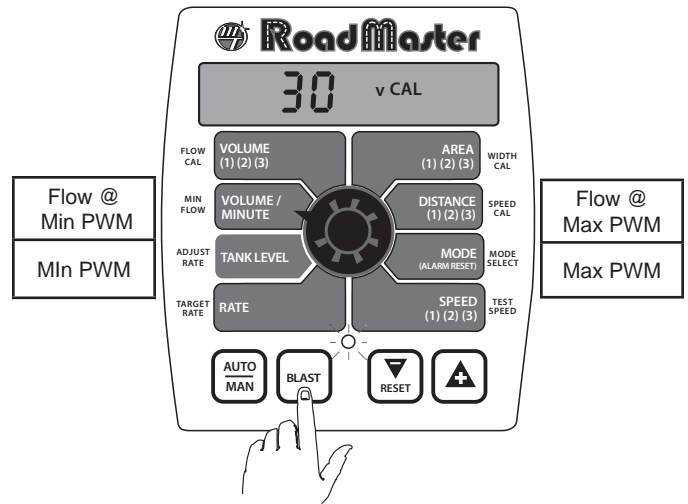

that only some of the sections are used. Either turning all sections off or toggling the pump off with the BLAST key can be used as an emergency shut off.

Whenever FLOW @ MIN PWM or FLOW @ MAX PWM is being displayed it will always be displayed with two decimal places (no auto decimal shift) so the operator can see all digits of the value that will be stored, just like using "SPECIAL" CALIBRATE (0.01 to 655.35).

NOTE: The following pages give details on the operation and adjustments when in Closed or Open Loop Operations.

Pulse Width Modulation (PWM) Live Calibrate (cont)

Closed Loop Operation

In Closed Loop operation, a flowmeter is available to measure the flow so all four calibrate factors can be programmed interactively using the following procedure.

NOTE: LIVE CALIBRATE is only used in PWM Drive. If the Console does not display "PULSE" during power up, this procedure does not apply.

1. Park the applicator in a safe location and configure the Booms as required for application.
2. Make sure all Booms have the correct nozzles installed.
3. Fill applicator with water. Note: All counters including Volume and Tank will not count (change) during this procedure.
4. Remain parked, unlock the console, place it in Hold (or turn all Booms off) and hold the "+" and "-" (Reset) switch for 1 second. This will start LIVE CALIBRATE and the V and CAL icons and the Warning LED will turn on. The pump will remain off until the BLAST key is pressed. See Illustration 12.

Illustration 12

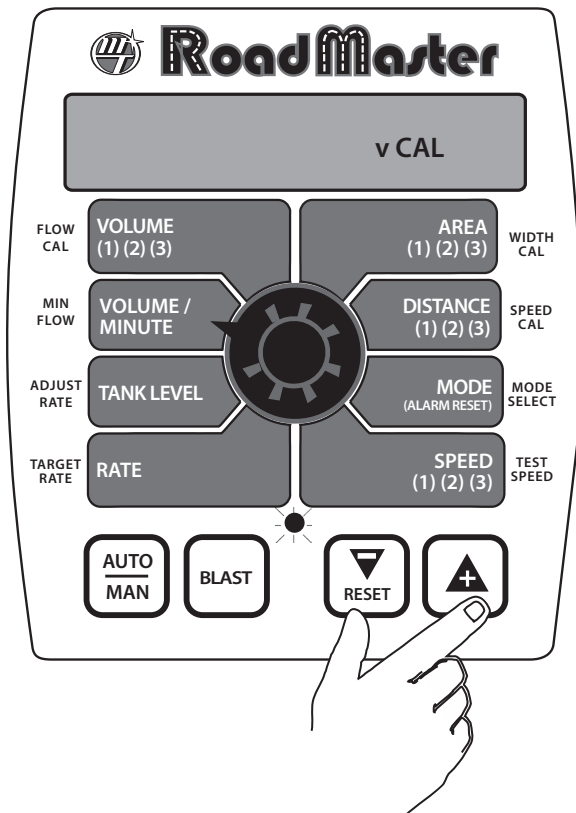

5. Turn all Boom switches on (or the Booms that will be used). The Remote Hold is ignored during this procedure so it can be left in either the RUN or HOLD position.

MINIMUM SETTINGS

NOTE: Skip Steps 6 through 9 if the Minimum settings are already correct.

6. Select the FLOW @ MIN PWM (Volume / Minute) or the MIN PWM (Tank Level) rotary position.
7. Press the BLAST key and the pump will begin to run at the default or last set MIN PWM rate. FLOW @ MIN PWM (Volume/Minute) position will display the measured flow in Gallons/Minute (liters/minute) and MIN PWM (Tank Level) position will show the PWM duty cycle (0 to 100%). This allows the PWM output to be adjusted while observing the change in flow rate. To stop spraying simply press the BLAST key again (but it will continue to display the last used FLOW @ MIN PWM or MIN PWM). See Illustration 13.

Illustration 13

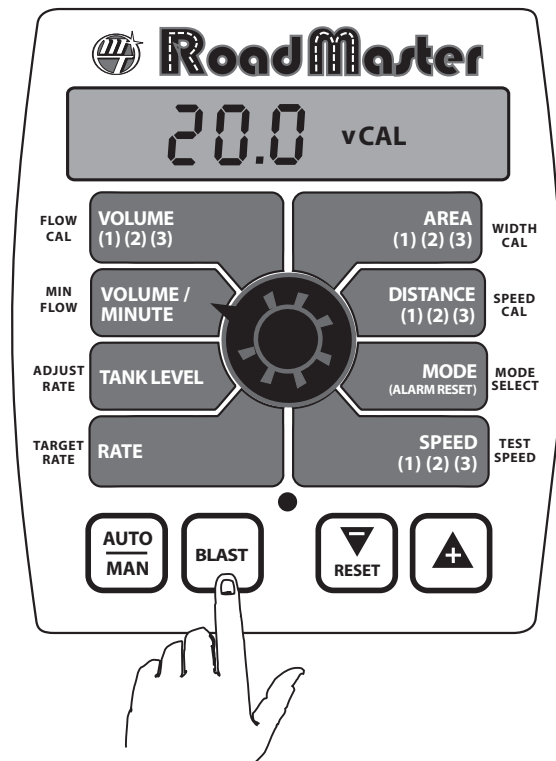

Pulse Width Modulation (PWM) Live Calibrate (cont)

Closed Loop Operation (cont)

8. While running, press the "+" and "-" (Reset) keys to adjust the pump speed until desired minimum flow rate, minimum pressure, minimum RPM or minimum PWM duty cycle is reached. The user may want to adjust the rate until it matches the minimum flow for the nozzles installed (minimum pressure) or the user may want to adjust it until it reaches the lower limit of the Hydraulic drive. During this adjustment the pump can be toggled on and off as desired using the BLAST key and the Rotary Switch can be changed between FLOW @ MIN PWM (Volume/Minute) or MIN PWM (Tank Level) as desired. The "+" and "-" (Reset) keys have no affect when the pump is turned off (via BLAST key or Boom Switches) so neither CAL factor can be changed without the other being updated. This keeps MIN PWM and FLOW @ MIN PWM in sync with each other during LIVE CALIBRATE. To make adjustments to just one CAL factor without affecting the other, then "Special" Calibrate should be used, instead of LIVE CALIBRATE.
9. When satisfied with the minimum flow rate and minimum PWM then press the BLAST key to toggle the pump off. If desired, the FLOW @ MIN PWM and MIN PWM can be written down for future reference.

Illustration 14

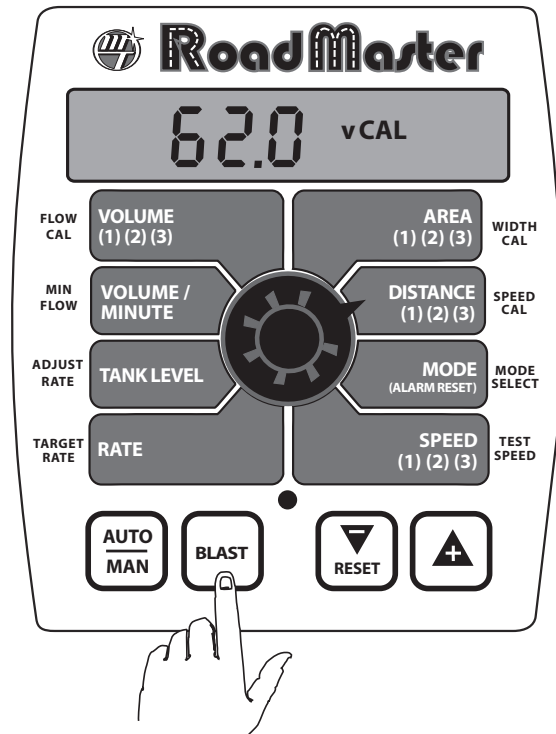

MAXIMUM SETTINGS

Skip Steps 10 through 13 if the Maximum settings are already correct.

10. Change the rotary to FLOW @ MAX PWM (Distance) or MAX PWM (Mode) position.
11. Press the BLAST key and the pump will begin to run at the default or last set MAX PWM rate. FLOW @ MAX PWM (Distance) position will display the measured flow in Gallons/Minute (liters/minute) and MAX PWM (Mode) position will show the PWM duty cycle (0 to 100%). This allows the PWM output to be adjusted while observing the change in flow rate. To stop spraying simply press the BLAST key again (but it will continue to display the last used FLOW @ MAX PWM or MAX PWM). *See Illustration 14.*
12. While running, press the "+" and "-" (Reset) keys to adjust the pump speed until desired maximum flow rate, maximum pressure, maximum RPM or maximum PWM duty cycle is reached. The user may want to adjust the rate until it matches the maximum flow for the nozzles installed (maximum pressure) or the user may want to adjust it until it reaches the upper limit of the Hydraulic drive. During this adjustment the pump can be toggled on and off as desired using the BLAST key and the Rotary Switch can be changed between FLOW @ MAX PWM (Distance) or MAX PWM (Mode) as desired. The "+" and "-" (Reset) keys have no affect when the pump is turned off (via BLAST key or Boom Switches) so neither CAL factor can be changed without the other being updated. This keeps MAX PWM and FLOW @ MAX PWM

in sync with each other during LIVE CALIBRATE. To make adjustments to just one CAL factor without affecting the other, then "Special" Calibrate should be used, instead of LIVE CALIBRATE.

13. When satisfied with the maximum flow rate and maximum PWM the press the BLAST key to toggle the pump off. If desired, the FLOW @ MAX PWM and MAX PWM can be written down for future reference.

STORE SETTINGS

14. If desired, the Minimum settings can be changed again by repeating steps 6 to 9 or the maximum settings can be changed by repeating steps 10 to 13. When satisfied with all four calibrate factors then press the "+" and "-" (Reset) keys for 1 second to exit LIVE CALIBRATE and store all four calibrate factors. To abort any changes to the LIVE CALIBRATE factors simply turn the power off.

NOTE: It is recommended (see steps 9 and 13), but not required, to turn the Pump off before switching between Min and Max Cal factors. When an unused position is selected (displays dashes) the Pump will turn off automatically and when a Min or Max Cal factor is selected again the pump can be toggled on again. Data collected while in a Min or Max position will be retained (even when a new position is selected), but it will not be stored until the user exits LIVE CALIBRATE.

Pulse Width Modulation (PWM) Live Calibrate (cont)

Open Loop Operation

In Open Loop operation, a flowmeter is not available to measure the flow so a calibrated container must be used to measure the actual flow using the following procedure.

NOTE: LIVE CALIBRATE is only used in PWM Drive. If the Console does not display "PULSE" during power up, this procedure does not apply.

1. Park the applicator in a safe location and configure the Booms as required for application.
2. Make sure all Booms have the correct nozzles installed.
3. Fill applicator with water. Note: All counters including Volume and Tank will not count (change) during this procedure.
4. Remain parked, unlock the console, place it in Hold (or turn all Booms off) and hold the "+" and "-" (Reset) switch for 1 second. This will start LIVE CALIBRATE and the V and CAL icons and the Warning LED will turn on. The pump will remain off until the BLAST key is pressed. See Illustration 15.

Illustration 15

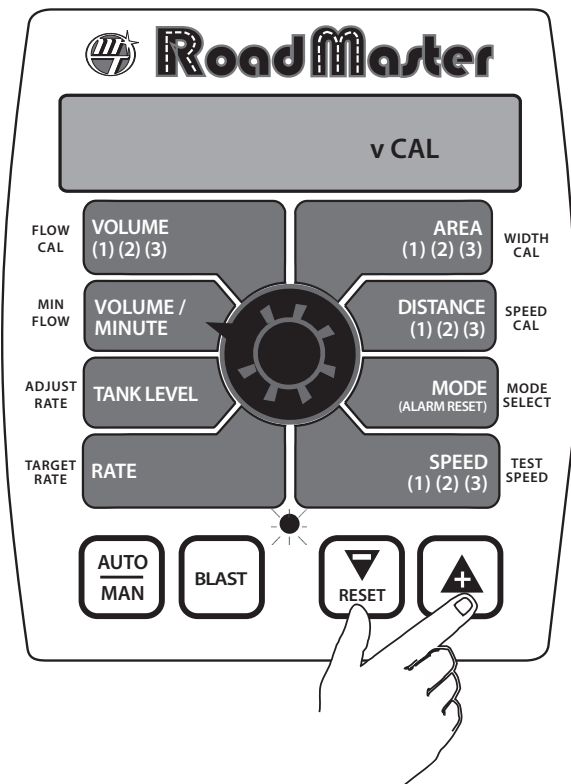

5. Turn all Boom switches on (or the Booms that will be used). The Remote Hold is ignored during this procedure so it can be left in either the RUN or HOLD position.

MINIMUM SETTINGS

Skip Steps 6 through 14 if the Minimum settings are already correct.

6. Select the MIN PWM (Tank Level) rotary position. The FLOW @ MIN PWM (Volume / Minute) position can not be used because no flowmeter is available to measure flow.
7. Press the BLAST key and the pump will begin to run at the default or last set MIN PWM rate and it will display MIN PWM duty cycle (0 to 100%). To stop spraying simply press the BLAST key again (but it will continue to display the MIN PWM). See Illustration 16.

Illustration 16

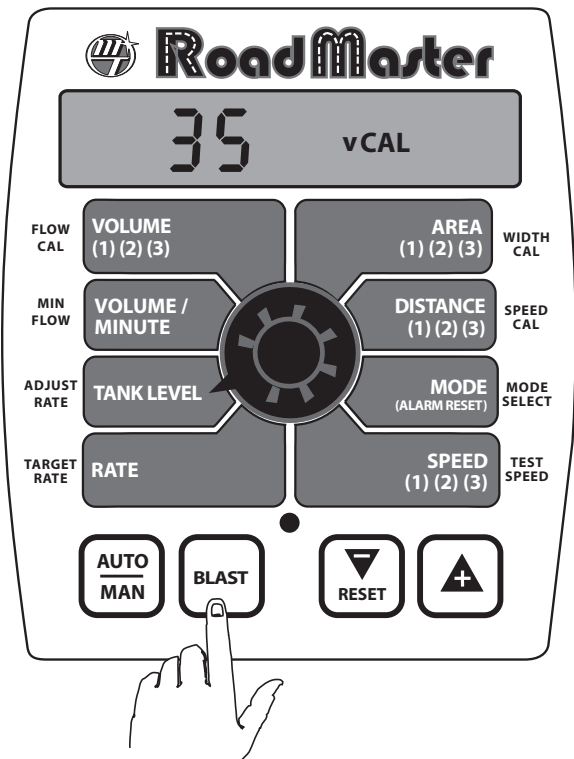

Pulse Width Modulation (PWM) Live Calibrate (cont)

Open Loop Operation (cont)

8. While running, press the "+" and "-" (Reset) keys to adjust the pump speed until the desired minimum pressure (using an external Pressure Gauge), minimum RPM (using an external RPM Indicator) or minimum PWM duty cycle (displayed on the console) is reached. The user may want to adjust the rate until it matches the minimum flow for the nozzles installed (minimum pressure) or the user may want to adjust it until it reaches the lower limit of the Hydraulic drive. During this adjustment the pump can be toggled on and off as desired using the BLAST key but the Rotary Switch should not be changed to the FLOW @ MIN PWM (Volume/Minute) position because that starts a 30 second timer. If the FLOW @ MIN PWM (Volume/Minute) position is accidentally selected then returning to the MIN PWM (Tank Level) position will reset the Timer. The "+" or "-" (Reset) keys will still change the MIN PWM even with the pump turned off.
9. When satisfied MIN PWM has been set correctly then press the BLAST key to toggle the pump off. If desired, the MIN PWM can be written down for future reference.
10. Place a calibrated container under one of the nozzles, or for maximum accuracy, capture all the flow from all the nozzles.
11. Select the FLOW @ MIN PWM (Volume/Minute) position. This will enable a 30 second Timer when the pump is started, and it will display 30.
12. Press the BLAST key and the pump will begin to run at the previously set MIN PWM rate and the display will show a 30 second timer that counts down. When it reaches zero it will automatically stop the pump and begin to display FLOW @ MIN PWM. The 30 second run can be aborted by pressing the BLAST key or by changing the Rotary Switch to the MIN PWM (Tank Level) position or any unused position. This will reset the 30 second timer so it can be started over after emptying the calibrated containers. *See Illustration 17.*
13. Use volume collected in the calibrated container to compute FLOW @ MIN PWM as follows:
 - If the flow from all nozzles was collected then convert it to gallons (or liters).
 - If the flow from a single nozzle was collected then multiply it times the number of nozzles and convert it to gallons (or liters).
 - Compute the FLOW @ MIN PWM = Gallons/0.5 or liters/0.5.

Illustration 17

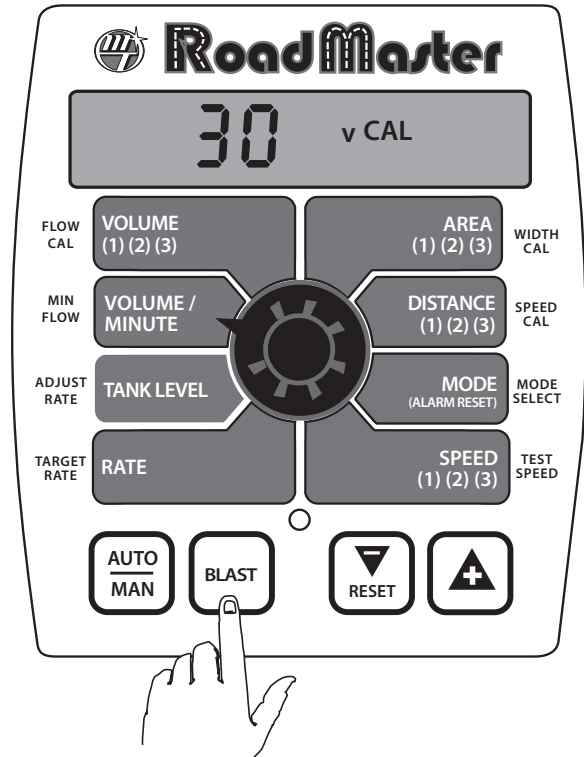

14. Use the "+" or "-" (Reset) keys to adjust the FLOW @ MIN PWM to the value computed in step 14. Be sure to complete this step before changing the Rotary Switch position since any changes will reset the 30 second timer and prevent changes to FLOW @ MIN PWM.

MAXIMUM SETTINGS

Skip Steps 15 through 23 if the Maximum settings are already correct.

15. Select the MAX PWM (Mode) rotary position. The FLOW @ MAX PWM (Distance) position cannot be used because no flowmeter is available to measure flow.

Pulse Width Modulation (PWM) Live Calibrate (cont)

Open Loop Operation (cont)

16. Press the BLAST key and the pump will begin to run at the default or last used MAX PWM rate and it will display MAX PWM (0 to 100%). To stop spraying simply press the BLAST key again (but it will continue to display the MAX PWM). See Illustration 18.

Illustration 18

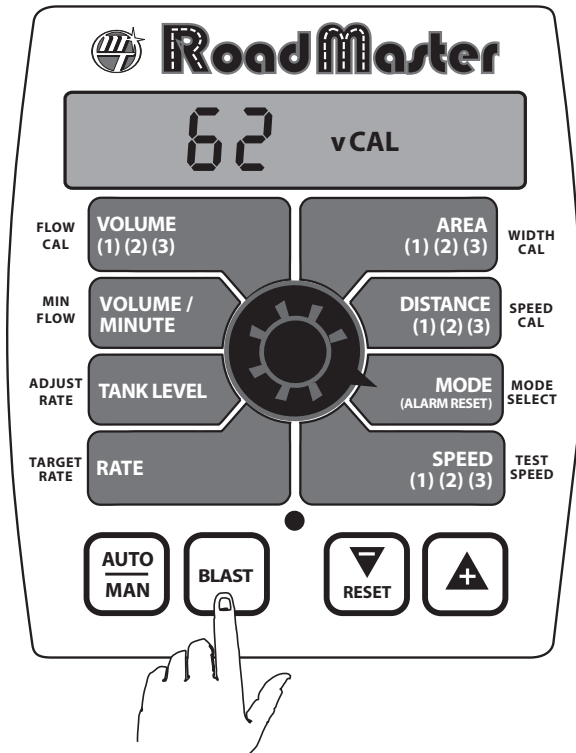

17. While running, press the "+" and "-" (Reset) keys to adjust the pump speed until the desired maximum pressure (using an external Pressure Gauge), maximum RPM (using an external RPM Indicator) or maximum PWM duty cycle (displayed on the console) is reached. The user may want to adjust the rate until it matches the maximum flow for the nozzles installed (maximum pressure) or the user may want to adjust it until it reaches the upper limit of the Hydraulic drive. During this adjustment the pump can be toggled on and off as desired using the BLAST key but the Rotary Switch should not be changed to the FLOW @ MAX PWM (Distance) position because that starts a 30 second timer. If the FLOW @ MAX PWM (Distance) position is accidentally selected then returning to the MAX PWM (Mode) position will reset the Timer. The "+" or "-" (Reset) keys will still change the MAX PWM even with the pump turned off.
18. When satisfied MAX PWM has been set correctly, then press the BLAST key to toggle the pump off. If desired, the MAX PWM can be written down for future reference.

19. Place a calibrated container under one of the nozzles, or for maximum accuracy, capture all the flow from all the nozzles.
20. Select the FLOW @ MAX PWM (Distance) position. This will enable a 30 second Timer when the pump is started, and it will display 30.
21. Press the BLAST key and the pump will begin to run at the previously set MAX PWM rate and the display will show a 30 second timer that counts down. When it reaches zero it will automatically stop the pump and begin to display FLOW @ MAX PWM. The 30 second run can be aborted by pressing the BLAST key or by changing the Rotary Switch to the MAX PWM (Mode) position or any unused position. This will reset the 30 second timer so it can be started over after emptying the calibrated containers.
22. Use volume collected in the calibrated container to compute FLOW @ MAX PWM as follows:
 - If the flow from all nozzles was collected then convert it to gallons (or liters).
 - If the flow from a single nozzle was collected then multiply it times the number of nozzles and convert it to gallons (or liters).
 - Compute the FLOW @ MAX PWM = Gallons/0.5 or liters/0.5.
23. Use the "+" or "-" (Reset) keys to adjust the FLOW @ MAX PWM to the value computed in step 22. Be sure to complete this step before changing the Rotary Switch position since any changes will reset the 30 second timer and prevent changes to FLOW @MAX PWM.

STORE SETTINGS

24. If desired, the Minimum settings can be changed again by repeating steps 6 to 14 or the maximum settings can be changed by repeating steps 15 to 23. When satisfied with all four calibrate factors then press the "+" and "-" (Reset) keys for 1 second to exit LIVE CALIBRATE and store all four calibrate factors. To abort any changes to the LIVE CALIBRATE factors simply turn the power off.

NOTE: For maximum accuracy the 30 second runs should not be disrupted by turning the pump off or by changing the Rotary Switch position (see Steps 12 & 21). However, the BLAST key, Rotary Switch or a Boom switch can be used for an emergency stop situation.

Troubleshooting

Messages/Warnings

A

Average Speed (for selected Data Set) is being displayed for 2 seconds.

bad^{CAL}

Indicates memory fault. Cycling power will not clear the bad CAL message, it can only be cleared by entering Calibration or "Special Calibration modes, checking and/or changing settings and exiting to save settings.

BLAST

BLAST is active (Blast key was pressed).

CLEAR

The message alerts the user that the currently selected counter will be cleared if the reset button is held for 2 seconds. Also serves as a reminder to use "+" button to select counters.

ESTOP

Had an Emergency Stop. Check flowmeter. Verify there is liquid flow and the tank is not empty. Can be overridden to continue application without a flowmeter by pressing BLAST if FLOW @ MAX PWM is correctly calibrated.

Error

Trying to select Metric Units in Turf Mode or Turf Mode in Metric Units.

FILL

Rotary switch in any position, **FILL** will flash if tank level is equal to or less than Tank Set Point or Float Switch detects empty Tank. Fill TANK. If using TANK counter and Tank Alarm Set Point reset TANK counter by setting the rotary switch at the TANK position and pressing the "+" button for one second. Check to make sure TANK ALARM SET POINT is properly calibrated.

H

Highest Speed (for selected Data Set) is being displayed for 2 seconds.

L.L.C.P.r.c.r

In Lane Mode when a Boom is selected for Width Cal a letter will display for 1 second that identifies the selected Boom. After 1 second the displayed BOOM letters clear and the Boom Width is displayed.

LoP

Low Power. Check all power and ground connections.

no boom

Will flash in display if rotary switch is in Width position, system is in Cal mode and no booms are turned on. Make sure system is in run and a boom switch is turned on, also check Run/Hold switch or sensor and connections.

no FLo

Will flash in display if rotary switch is in RATE position and should have flow (In Run, some booms on, speed greater than 0) but no flow is detected. Check flowmeter and flow harness connections per Troubleshooting section.

no SPEEd

Will flash in display if rotary switch is in RATE position and there is no Speed signal regardless of all other conditions. Check speed sensor and connections per Troubleshooting section.

99999

Counters (DISTANCE or AREA or VOLUME) have reached their maximum. RESET (see page 25) to clear counters and resume counting.

SPEC

"Special" Calibration mode is active. Appears when entering Special Calibration mode (hold AUTO/MAN and CAL buttons while turning console on).

— — — —

An unused SPECIAL CALIBRATE or LIVE CALIBRATE position.



Warn LED flashes when the Rate error is over 10% or Volume/Minute is below the Minimum, or Tank is less than Tank Set Point. It is on steady when in CAL mode or SPECIAL CAL mode or Test Speed if console is unlocked.



Audible Alarm

Alarm will sound if Alarm Enable is ON and either the Tank Level is below minimum or the Optional Tank Level Switch is active, or if Application Rate error rate is greater than 10% and the console is in Auto with adequate ground speed.

Troubleshooting

General

All ROADMASTER PWM consoles, flowmeters and harnesses are tested prior to packaging, so unless there has been damage in shipment you can be confident that everything will be operational when you receive it.

However, if you do encounter a problem that appears to be related to equipment failure, **PLEASE DO NOT OPEN THE CONSOLE**. Your system is protected by a warranty, and Micro-Trak Systems, Inc. will gladly correct any defect.

Many problems are the result of mistakes in installation or operation. Before returning any parts for service, carefully check your installation and review the operating instructions. For easy-to-follow guidelines, refer to the troubleshooting section which follows.

CONSOLE APPEARS DEAD

Using your test light, check for 12 volts at the power source. Trace cable toward battery looking for breaks. Also check any fuses or circuit breakers that supply power to the console. Then check for damaged power cable or reversed terminals. (Console requires 12 volts for proper operation).

SPEED IS ALWAYS ZERO OR ERRATIC

Check for properly calibrated SPEED CAL number.

Review speed sensor installation. If using a Magnetic Speed Sensor, check for proper mounting, alignment and spacing of speed sensor in relationship to magnet assembly. Make sure magnet polarities are alternated. Also check cable for breaks or incomplete connection.

For more suggestions on solutions to speed problems, see console input section and Troubleshooting SPEED Sensor section on next page.

AREA COUNT IS INACCURATE

Implement width or Speed Calibration was measured incorrectly or programmed incorrectly. Go back through the original procedures, make changes, and test for area count again. Verify accuracy with formula:

$$\text{Turf} = \text{Distance} \times \text{Width in feet} / 1000$$

$$\text{Yard}^2 = \text{Distance} \times \text{Width in yards}$$

$$\text{Acres} = \text{Distance} \times \text{Width in feet} / 43560$$

$$\text{Hectares} = \text{Distance} \times \text{Width in meters} / 10,000$$

$$\text{Meters}^2 = \text{Distance} \times \text{Width in meters}$$

DISTANCE COUNT IS INACCURATE

Speed Calibration was incorrectly measured or entered. Review calibration, readjust and test. *See Appendix C.*

NO READOUT OF GALLONS (LITERS), OR GALLONS (LITERS) PER MINUTE

Check to see that the pump and equipment are operating properly. If liquid is moving through the line, check the flow sensor to be sure it is screwed all the way into the flowmeter.

Check to see that a FLOW CAL number has been entered.

Also check cable for breaks or incomplete connection. (*See Console Input Section*). If the flowmeter is new or has not been used for a long period of time, the turbine may be sticky. Flushing the system out with water should make the turbine spin freely.

Flow rate may be too low to register a reading, or foreign material may be lodged in the flowmeter. Shaking the Flowmeter end to end should produce a "rattling" sound (shaft end play). Blowing in the meter from either end should spin the turbine freely. *See Flowmeter Assembly; Appendix E, for details.*

If using Open Loop or Closed Loop Override, check Flow @ MIN PWM and Flow @ MAX PWM. Perform LIVE CAL!

TOTAL LIQUID USED IS INACCURATE

This may result from an incorrectly-entered "FLOW CAL" value. Check the number stamped on the flowmeter tag, and be sure this is entered in the console's "FLOW CAL" position. If the meter has been used for some time, wear may have changed the Flow Cal value.

Check the mounting position of the flowmeter. With lower flow rates, the meter should be mounted vertically with flow going up.

Another cause may be inaccurate sprayer tank markings.

If using Open Loop or Closed Loop Override, check Flow @ MIN PWM and Flow @ MAX PWM. Perform LIVE CAL!

ELECTRICAL INTERFERENCE

Erratic operation of the system may be the result of electrical interference from ignition wires or inductive loads (electrical clutch, fan, solenoid, etc.).

Always try to route wires as far away from suspect areas as possible. If problems occur, you may need to relocate the console and/or wiring harness, or install a noise suppressor and/or spark plugs.

DISPLAYED MEASUREMENTS DO NOT MAKE SENSE

The console may be in the incorrect measurement units (English or Metric) or Application mode.

NOTE: Changing UNITS will load defaults, so they should always be changed first and then all other CALIBRATE and SPECIAL CALIBRATE values may be set.

MODE SELECT in Calibrate allows the user to change the MODE. Pressing the "+" or "-" (Reset) will toggle between Lane, Ag, Dust and Turf (except in Metric) MODE and the display will show LANe, Ag, dUSt and turf.

DISPLAY READS "99999"

DISTANCE, TOTAL AREA, and TOTAL FLOW will read 99999 when they have reached their maximum count. Reset to zero to resume counting.

Troubleshooting (cont)

Checking Individual Components

CONSOLE INPUTS

If there is no response from any of the following tests, refer to the main wiring diagram to locate the next connector in line toward the console and repeat the test at that connector. If there is a response at that connector, the problem may be in the cable between the two connectors (or the connectors themselves).

SPEED INPUT: Turn rotary switch to SPEED position and disconnect the speed sensor (yellow tie) from the main harness. Check for 12 volts between pins B (red) and C (yellow) of the main harness speed cable (yellow tie). Using a clip lead or other jumper wire (such as a paper clip bent in a "U"), several times rapidly short together pins A (orange) and C (yellow) of the 3-pin connector (See Illustration Below). The console should respond with some speed reading.

FLOW INPUT: Turn rotary switch to VOLUME/MINUTE (not RATE) and disconnect the flow sensor (green tie) from the main harness. Check for 12 volts between pins B (violet) and C (gray) of the main harness flow cable (green tie). Using a clip lead or other jumper wire (paper clip bent in a "U"), several times rapidly short together pins A (blue) and C (gray) of the 3-pin connector (See Illustration Below). The console should respond with some Volume/Minute reading.

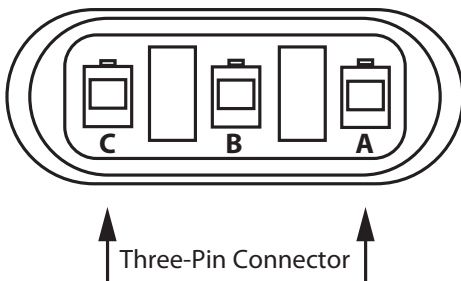

TANK SWITCH INPUT: First Verify that ALARM ENABLE is ON. (See "Special" Calibration page 19). With ALARM ENABLE turned ON, if the Tank Switch is opened, the Audible Alarm should turn on after a 15 second delay. If the switch is closed, the alarm will turn off. Verify by disconnecting the switch and shorting pins A and C on the cable connector.

RUN/HOLD INPUT: If using P/N 21778 (Run/Hold Switch Kit) or other switch, disconnect the cable from the switch and the HOLD Icon will NOT be displayed. Short between pins A and C and the HOLD Icon should turn on; if not, the console input is bad, otherwise either the switch or extension cable is bad. If using a Hall-Effect magnet Run/Hold sensor, first check for 12V between B and C, then proceed per above.

HARNESS

The harness can be checked using an ohmmeter or continuity tester. The main wiring diagram shows the pin-out of all connectors. See page 7 for wiring diagram

MAGNETIC HALL-EFFECT SPEED AND FLOW SENSORS

Caution: Improper connection or voltage could damage the Hall-effect sensor.

This particular type of Hall-effect sensor requires alternating magnetic polarities in order to switch. This means that the north pole of a magnet will "open" the Hall effect and the south pole of a magnet will "close" the Hall effect.

Ground pin C (black) and connect clean 12 volts to pin B (white) of the Hall-effect sensor cable. Connect the positive lead (red) of an ohmmeter or continuity tester to pin A (red) and the negative lead (black) of the ohmmeter or continuity tester to pin C of the Hall-effect sensor cable.

Holding the tip of the sensor up to the north pole of a magnet should result in a very high resistance (infinite), while holding the tip of the sensor up to the south pole of a magnet should result in a very low resistance (near zero).

ASTRO II AND ASTRO 5 GPS

Carefully check your installation and operating instructions.

1. Make sure that power (12 VDC is available to the sensor and complete the Speed Input tests. (See Console Input section).
2. Check to make sure that the GPS module is securely mounted.
3. Check for any damage to the 10 foot receiver cable.
4. If system passes all above tests, the Astro may be defective.

VANSCO RADAR SPEED SENSOR

Carefully check your installation and operating instructions. The following are tips for troubleshooting;

1. Make sure that power (12 VDC is available to the sensor and complete the Speed Input tests. (See Console Input section).
2. If system passes all above tests, the radar may be defective.

ELECTRIC SECTION VALVES

If 12 volts and signal are present, but valves will not actuate, consult valve manufacturer's troubleshooting instructions.

PLUMBING

Proper plumbing is a very important factor in obtaining optimal performance from your ROADMASTER PWM system. In addition, make certain that you have selected and installed the correct spray tips for the application, speed and spray rate that you intend to maintain. Don't forget the obvious such as leaky fittings and hoses, pinched hoses and plugged or worn nozzles.

Plumbing Guidelines

GENERAL

In order for your sprayer to function properly, it must be correctly plumbed.

A word about pressure drops: All hose, valves and fittings (especially elbows) cause undesirable pressure losses. Keep hoses as large as practical. Don't use longer hoses than necessary. Avoid bends whenever possible. Use as few fittings as possible. Use full port valves or the next larger size valve. Long hoses should be supported to avoid sagging and kinking. Many spray tip manufacturers have charts showing pressure drop for various fittings and hose sizes.

Now let's break the system into three sections and cover each one separately. The three sections are the pump inlet line, the flowmeter line, and the pump itself.

PUMP INLET

The hose connecting the tank to the pump should be at least as large as the pump inlet port. The valve in this line is for complete tank shut-off only and should always be fully open during operation. If this hose is too small or the valve is partially closed, you may not be able to reach your high end goals and pump damage could occur.

FLOWMETER

The line feeding the flowmeter and the section shut-off valves should be at least as large as the flowmeter. The size of lines going from the shut-off valves to each section depends on the flow rate of each section.

PUMP

The pump must have enough capacity to satisfy the flowmeter sections of the plumbing. To determine if your pump is large enough you must add up the volume per minute of all active sections.

Appendices

Appendix A

Optional Speed Sensor Mounting Installation

Magnets

Please read the following information about magnet spacing and polarity.

The number of magnets that must be used depends on the size of your tire and where you mount the sensor. On wheels the general rule of thumb is one magnet for each wheel bolt (minimum of two, and always an even number). For drive shafts, two magnets are usually adequate.

Some installations may require that more than two magnets be installed. To determine the number of magnets required, measure the distance traveled of one revolution of the sensor equipped wheel in inches (centimeters).

See the following tables to find the minimum number of magnets required (always an even number) - The magnets provided by Micro-Trak are marked with a punched dashed line on the SOUTH pole side of the magnet. *See Illustration 19A.*

NOTE: Always use an even number of magnets, and always alternate the polarities of the magnets as you go around the wheel hub or drive shaft.

To install, mount the first magnet with the SOUTH pole side (dashed line) facing toward the hub or shaft. Mount the second magnet with the NORTH pole side facing toward the hub or shaft. *See Illustration 19B.*

For proper operation, the magnets must be evenly spaced around the wheel or drive shaft. The magnets must be at least 1" apart. *See Illustration 19C.*

NOTE: Magnets may be attached mechanically or adhered with epoxy or other high quality adhesive. When using adhesive, thoroughly clean the area of dirt and oil.

English (inches)

Wheel Circumference	40	80	100	160	200
Number of Magnets	2	4	6	8	10

Metric (cm)

Wheel Circumference	100	200	300	400	500
Number of Magnets	2	4	6	8	10

Locations where the magnetic sensor may be installed:

1. Non-driven wheel on the vehicle. This is less susceptible to errors resulting from wheel slip.
2. Vehicle driveshaft. This type of mounting is recommended for trucks, four-wheel drive tractors or other equipment that has poor or no access to a non-driven wheel. *See Appendix B* for magnetic speed sensor installation details for various types of wheels or drive shaft.

Locate the Following Parts:

- Speed Sensor Cable (Green Body)
- Mounting "L" Bracket
- Magnets
- Cable Ties

Illustration 19A

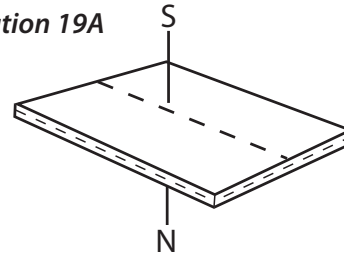

Illustration 19B

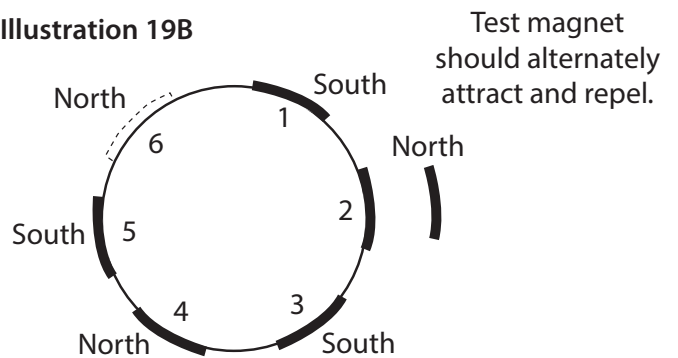
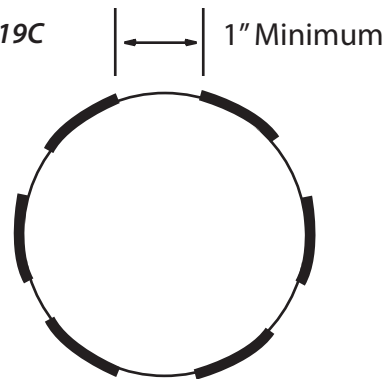

Illustration 19C



Appendix A (cont)

Attaching the Speed Sensor

The magnets are attached to a wheel hub or drive shaft and the speed sensor is mounted directly over the magnet. When the wheel or drive shaft begins turning, a speed impulse is sent to the ROADMASTER PWM console every time a magnet passes by the tip of the speed sensor. For the speed sensor to operate properly, the spacing between the magnets and the tip of the sensor must always remain constant. Before permanently mounting any parts, be sure that the location you have selected will meet the requirements shown in *Illustration 20*.

NOTE: Observe magnet polarities (see previous section).

Illustration20

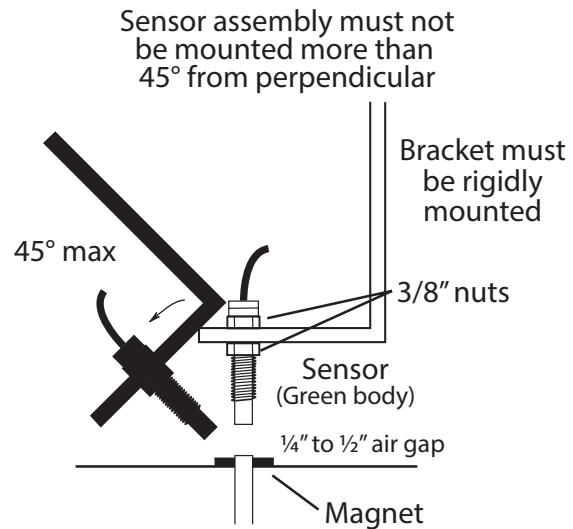

Connecting the Speed Sensor Cable

The speed sensor cable has a GREEN sensor body and mates with the 3-pin connector which is marked with a yellow cable tie. The speed sensor and the flow sensor are identical, but must be connected to the proper harness connector. The speed sensor always connects to the 3-pin M/P connector with the YELLOW tie and flow sensor always connects to the 3-pin M/P connector with the GREEN tie.

See the ROADMASTER PWM Wiring Diagram on page 8.

The optional Run/Hold sensor, also uses the same type of connector as the speed and flow sensors. However, the Run/Hold sensor has a GRAY tie near the 3-pin connector, the sensor body is BLACK, and it always connects to the main harness lead with the GRAY tie.

See the ROADMASTER PWM Wiring Diagram on page 8.

SENSOR IDENTIFICATION CHART

Sensor	Sensor Body Color	Main Harness Tie Color
Speed	Green	Yellow
Flow	Green	Green
Run/Hold	Black	Grey

Appendix A (cont)

Optional Speed Sensor Mounting on Drive Shaft

NOTE: This is an optional method generally used on pickups or custom vehicles. It may also be necessary on any other vehicles where access to the wheels is limited. *This installation requires a "Special" calibration procedure, see page 31.*

Determine the best location for the magnets on drive shaft according to which is the most practical spot to attach sensor mounting bracket. This position should be no more than 12" (.30 meters) behind the front U-joint. For best results, mount "L" bracket to transmission and mount magnets on drive shaft as close to transmission as possible. This will ensure proper alignment if drive train shifts under heavy loading.

Two magnets are required for proper Hall-effect speed sensor operation. Position them exactly opposite each other (180 degrees apart). The polarity (north and south poles) detected by the Hall-effect speed sensor must alternate as the shaft is turned. The magnets provided by Micro-Trak are marked with a punched dashed line on the SOUTH pole side of the magnet.

- Attach magnets onto drive shaft, one NORTH pole side out and the other SOUTH (dashed) pole side out, by wrapping cable tie around shaft and magnets. Position each magnet so that its longest dimension moves in the direction of rotation. Pull cable tie tight and trim off excess. An adjustable, non-magnetic (stainless steel) band clamp may also be substituted.
- Attach sensor bracket to vehicle transmission with bolts, lock washers and nuts provided. *See Illustration below.* (Use self-tapping screws if bolts are not practical.) Use either the short or long end of the bracket as a base. (Allow enough room between the bracket and the magnets so that when properly spaced, the tip of the sensor will extend 1/4" [7mm] or more beyond the locking nut.)
- Turn one locking nut onto threaded sensor and insert sensor into large hole selected on mounting bracket. Turn on remaining locking nut. Set sensor to proper distance from magnets (1/4" to 1/2", or 6mm to 13mm). When distance is set, tighten nuts to lock sensor in place.
- Secure sensor cable to frame with cable ties. Place first tie as close to sensor assembly as possible.

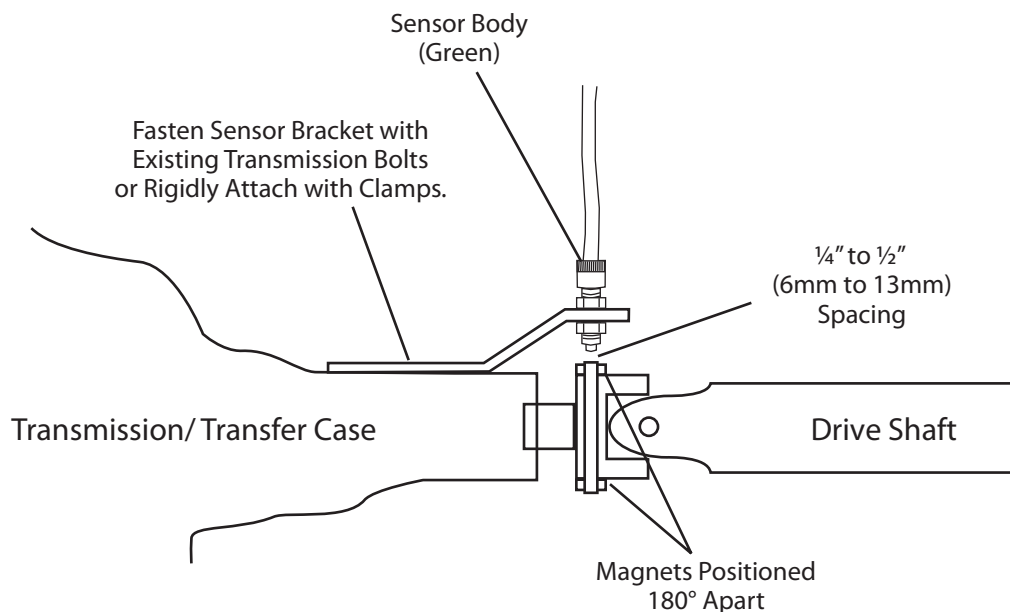

Drive Shaft Speed Sensor Calibration

Because of the difference in wheel-to-drive shaft ratios, it is difficult to determine a calibration value for installation on a drive shaft by measuring a wheel. You must start with an estimated calibration value (10-15) and then fine-tune the calibration.

Go to Appendix C for Fine-Tuning Instructions.

Appendix B

Calibrating if Using a Magnetic Speed Sensor

Determining the SPEED CAL

For the console to calculate the correct speed and measure distance accurately, the circumference of the sensor-equipped wheel must be entered. Determine the circumference of the sensor-mounted wheel to the nearest tenth of an inch (tenth of a centimeter) with the following method:

METHOD

Mark the tire with a piece of chalk and measure the distance traveled on the ground for one complete revolution. *See Illustration 21.* For improved accuracy, it is recommended that you perform this function in field conditions, measure several revolutions, and take the average.

Divide the measured revolution by the number of magnets installed to get your starting SPEED CAL calibration value. Once calibration of the system is complete, this number should be fine-tuned for optimum accuracy.

For fine-tuning the SPEED CAL value, see Appendix C on page 43.

Illustration 21

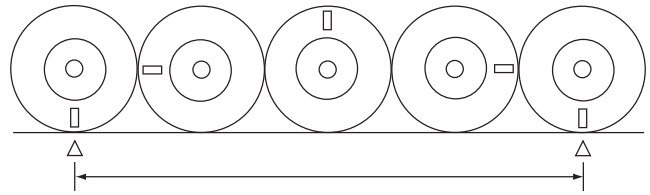

To determine SPEED CAL, measure the distance of one complete wheel revolution and divide by the number of magnets installed.

Appendix C

Fine Tuning Speed Distance Calibration Valve

This procedure is used to verify the Speed/Distance calibration. In order to achieve accurate measurements, each step in this fine tuning procedure should be performed as precisely as possible.

PREPARATION

- Once the system is fully installed and calibrated, select a straight tract of ground that is similar to your actual application conditions and as level as possible.

NOTE: Using a course with a different ground surface, such as a hard-surface road, will result in different readings than exact application conditions.

- Measure an appropriate distance for Application Mode. AG and TURF are measured in feet (meters). Dust is measured in yards (meters) and Lane is measured in miles (km). Clearly mark the beginning and end points with flags or something highly visible to the operator.

PROCEDURE

- With the console turned ON, place the Run/Hold switch in the HOLD position. The HOLD icon will be displayed. Select the Counter (1 - 3) you want to use. Be sure the display shows 0. If not, reset the distance counter by pressing and holding "RESET" until the display returns to 0 (approximately two seconds). The word CLEAR will be displayed when reset is pressed. Make sure pump is off. Turn on section switches.
- You are now ready to drive the measured course. Pick a location on the vehicle to use as a marker for starting and stopping the distance counting function (door handle, mirror, step, etc.). You should begin driving the course well ahead of the starting flag and drive past the ending flag, using the Run/Hold switch to start and stop the counting function. It is not recommended to start from a dead stop at the starting flag and stop at the ending flag.
- Place the Run/Hold switch in RUN when the marker on the vehicle passes the starting flag to activate the distance counting function. The console display numbers will increase, adding to the distance total as you drive. Drive the pre-measured course and place the Run/Hold switch in HOLD, when the marker on the vehicle passes the ending flag, to stop the distance counting function. The console display should display "HOLD". Stop the vehicle in a level and safe area and continue with this procedure.

- With the rotary dial still at DISTANCE (SPEED CAL), press and hold the "BLAST" key for one second. Once the console is in "CAL," the speed calibration value will be displayed. Momentarily press BLAST and the word CAL will begin to flash and the distance travelled will be displayed. *See Illustration 22.*
- When the display shows distance ("CAL" is flashing), verify whether the number displayed is the exact distance you drove (within +/- 1 - 2 %). If not, press the "+" or "-" key to adjust the figure to match the distance you actually drove. If the display reads too high, use the "-" key to lower the displayed value. If the display reads too low, use the "+" key to raise the displayed value.
- When the number shown on the display matches (as closely as possible) the actual distance driven, you have arrived at the correct calibration value. If you cannot adjust the displayed distance to exactly match the actual distance driven, adjust the figure as close as possible to the actual distance. You may check the calibration number by momentarily pressing BLAST. The word CAL will stop flashing and the SPEED CAL number will appear. Exit "CAL" by pressing "BLAST" for one second.

The speed sensor is now calibrated. To verify proper calibration, repeat the procedure a second time. Write down the new speed calibration number and keep it in a safe place. If the calibration values are ever accidentally changed, you can simply re-enter this number.

Illustration 22

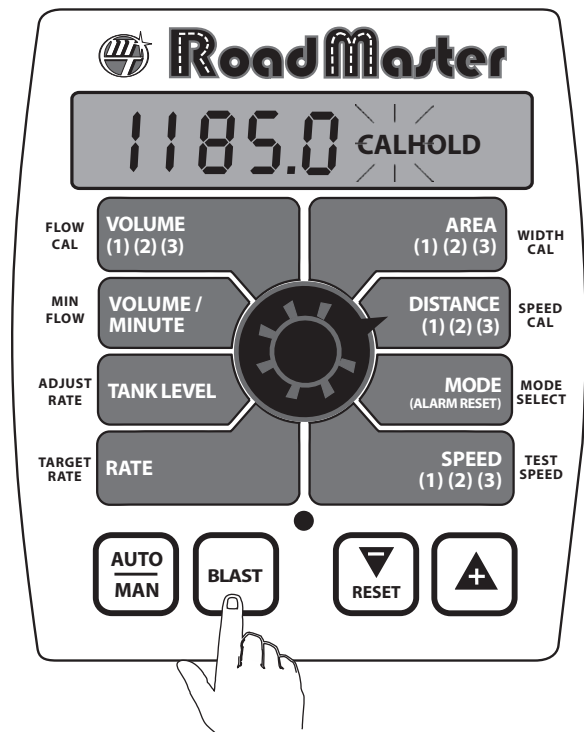

Appendix D

Fine Tuning Flowmeter Calibration Valve

This procedure is used to verify and fine-tune the flowmeter calibration. Every flowmeter is calibrated with water at the factory and stamped with a calibration value. Enter that value as a starting point and use this procedure to fine-tune that value for your specific installation and spraying application. This procedure should be repeated each time a new solution is being applied (differing solutions will have a different specific gravities and different flow characteristics) or when the flowmeter installation has been altered.

PROCEDURE

1. Fill sprayer tank with water, preferably 100 gal. or more. The larger the volume of water used, the more accurate will be the calibration.)
2. Start sprayer pump and turn on section switches. Run enough water to purge all air from lines. Turn off sections but leave pump running.
3. Turn console rotary selector to the VOLUME position. Select the counter (1-3) that you want to use. Press and hold the RESET button until the display reads CLEAR and then goes to 0.0 (about 2 seconds).
4. Turn on all sections, and run a known amount of water (preferably 100 gallons or more). *
5. Turn off all sections. Compare the console's VOLUME reading with the known amount of water run. If the two amounts are within one or two percent, no fine tuning is required. If the two amounts are more than two or three percent different, continue with the next step.
6. With the console still in the VOLUME position, enter calibration (section switches OFF, hold the BLAST button until red warning light comes on; about one second). The display will show the flowmeter calibration value and the CAL icon.
7. Momentarily press the BLAST button. The CAL icon will begin to flash and the total volume will be displayed. **See Illustration 23.**

8. When the TOTAL FLOW value is displayed, use the "+" or "-" button to adjust the value to match the amount of water run.
9. Momentarily press the BLAST button. The word CAL will stop flashing and the flowmeter calibration number will be displayed. You will notice that the flowmeter calibration value has changed. Write down the new flowmeter calibration value. This is your "fine tuned" calibration value, keep it for future reference.
10. Exit calibration by holding the "BLAST" button until the red warning light goes out (about one second).

* The most accurate method to measure the volume of water run is to place a container under EVERY nozzle and add together the amount from each nozzle. This assures that 100 percent of the water is collected and that all nozzles are spraying equally. It is important to perform this procedure at a flow rate similar to that which will be used in the field. It is also possible to disconnect the main boom line and run it to a large measuring container but a valve must be installed and properly adjusted to simulate actual field conditions.

Illustration 23

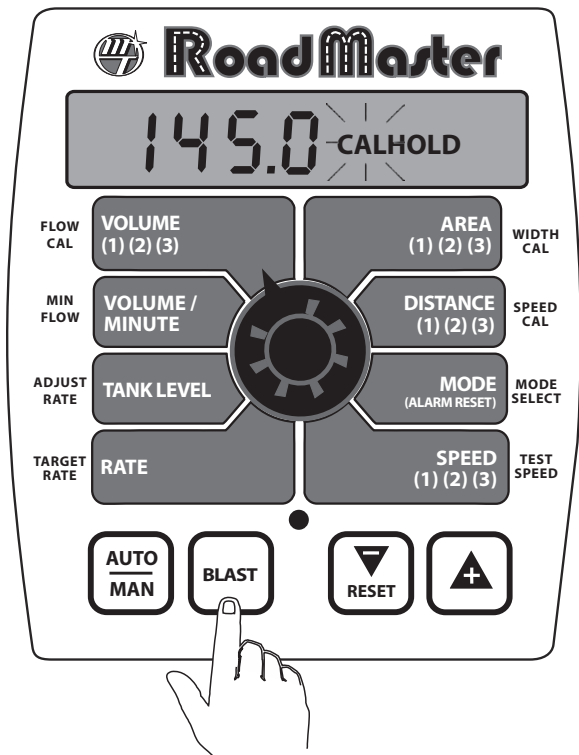

Appendix E

Flowmeter Assembly

IMPORTANT: Opening the flowmeter will void the Flowmeter Calibration value assigned to your unit. However, you may need to take the flowmeter apart for periodic cleaning or to remove an obstruction.

If you can shake the flowmeter from end-to-end to produce a “rattling” sound (shaft-end play), or if you can blow into the meter from either end and cause the turbine to spin freely, your flowmeter does not need cleaning. If you cannot hear the “rattling” sound or get the turbine to spin freely, your flowmeter needs to be cleaned. See Illustrations below for reassembly instructions.

OPENING THE FLOWMETER

Cut the calibration tag retaining wire. Remove the screws and disassemble the flowmeter. Do not attempt to remove the sleeve bearings from the flowmeter housing.

Use warm water and if necessary, a mild detergent and a soft bristle brush to clean all parts. Do not use solvents or diesel fuel to clean the flowmeter. A magnet works well for removing fine metallic particles from the turbine. Inspect all parts. Check for excessive bearing or shaft wear. The shaft will wear shorter until the turbine drags on the housing. When the shaft is worn to the point of drag, the turbine must be replaced.

On a flat surface, place each housing half on end. Set and spin the turbine in each half. It should spin freely. If it does not spin freely, remove the turbine, wipe the shaft and try again. If it still does not spin freely, the shaft or bearings may have excessive wear. (Service may be necessary.)

Complete assembly FM750 GFN Flowmeter

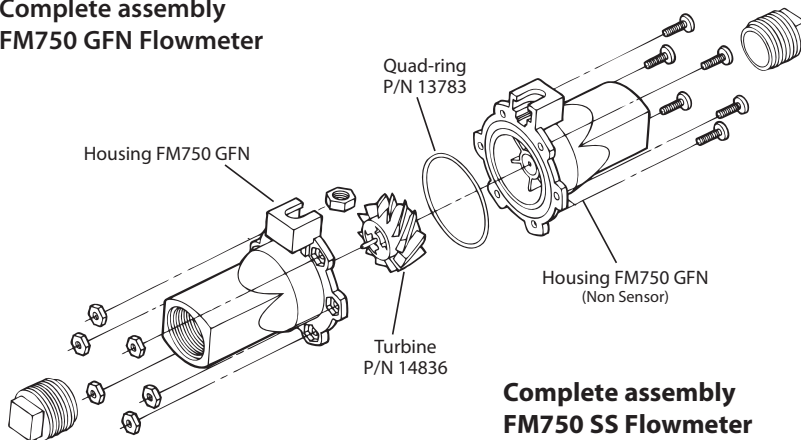

Complete assembly FM750 SS Flowmeter

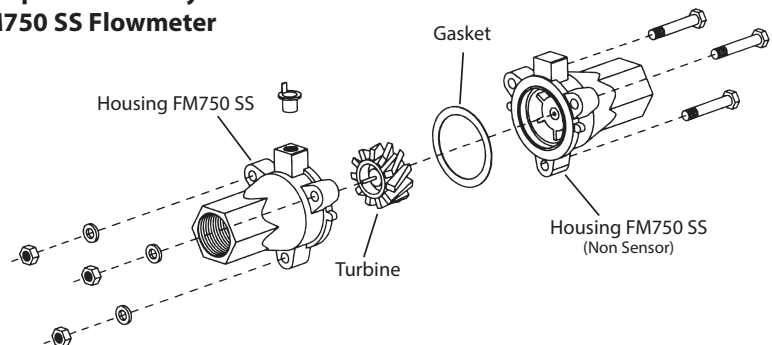

ASSEMBLING THE FLOWMETER

Stainless steel meters use a Teflon gasket. Sealants are normally not required. Plastic meters use an o-ring (Quad-ring). Apply a small amount of silicon grease for lubrication. Gaskets and o-rings may be reused several times but eventually may need replacement.

Place the turbine in the non-sensor housing. Position gasket/o-ring; carefully place sensor housing over turbine. Drop all screws into holes. Hold nuts (and lock washers on stainless meters) in place and finger-tighten screws. Ensure proper placement of gasket/o-ring and evenly tighten all screws. Attach tag.

After assembly, shaking flowmeter end-to-end should produce a “rattling” sound (shaft end play). Blowing into the meter from either end should cause the turbine to spin freely. If the turbine only spins from one direction, install the flowmeter so that the liquid flows in that direction (service may be required).

For maximum accuracy the flowmeter should be mounted in a vertical position. Recalibration is required before field operation.

Appendix F

Radar "Y" Adapter Cables



RADAR	CONNECTOR	SIGNAL PIN
DICKEY-john	Amp	2
DICKEY-john	Cannon	3
DICKEY-john	Deutsch	3
DICKEY-john	Ford	2
DICKEY-john	Packard	B
In-Cab JD (8000 & 9000's)	Metri-Pack	A
Magnavox & Phillips	Packard	C
Raven	Conxall	3
Vansco	Amp	2

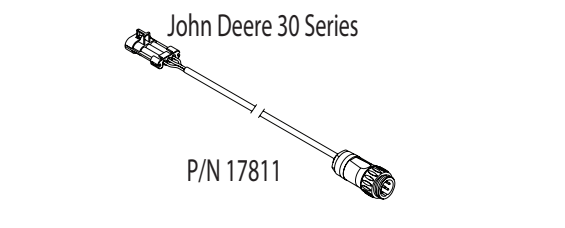
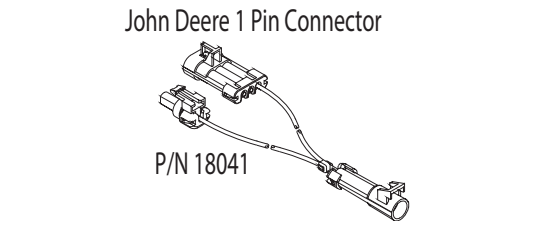
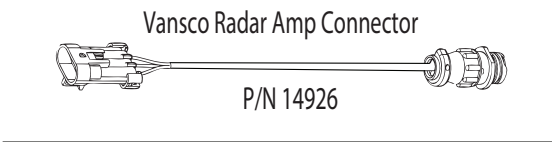
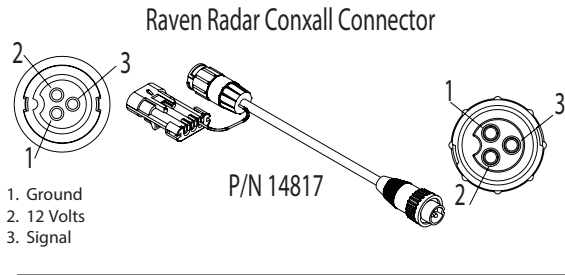
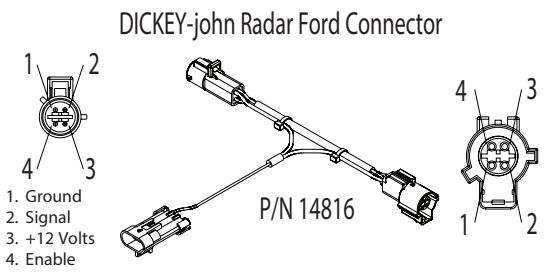
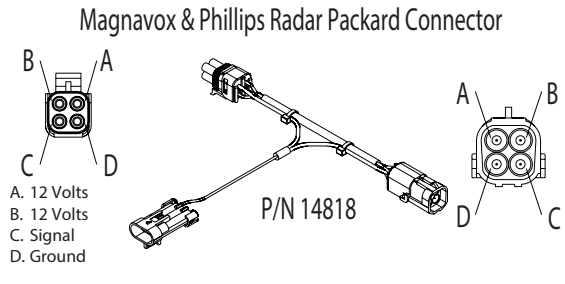
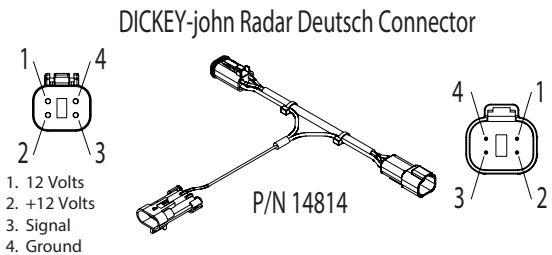
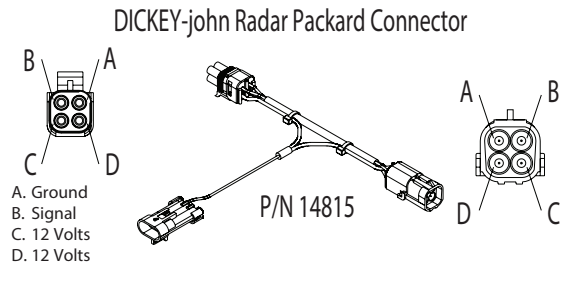
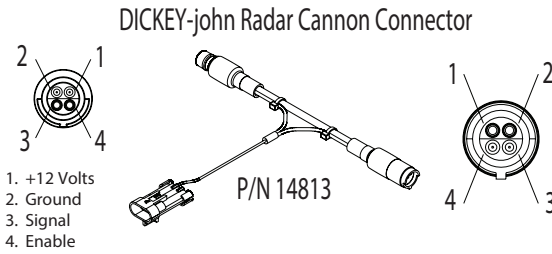
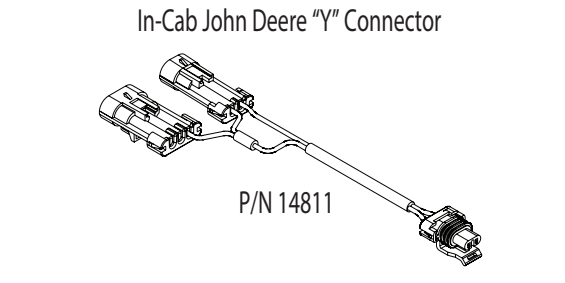
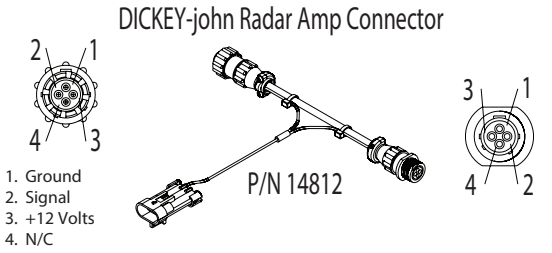

Appendix G

Conversion Chart

English to Metric		
When You Know	Multiple By	To Find
LINEAR MEASUREMENT		
inches	25.4	millimeters
feet	0.305	meters
yards	0.914	meters
miles	1.61	kilometers
LAND MEASUREMENT		
square inches	645.16	square millimeters
square feet	0.093	square meters
square yards	0.836	square meters
acres	.405	hectares
square miles	2.59	square kilometers
LIQUID MEASUREMENT		
fluid ounces	29.57	milliliters
pint	0.473	liters
quart	0.946	liters
gallons	3.785	liters
VOLUME		
cubic feet	0.028	cubic meters
cubic yards	0.765	cubic meters
DRY MEASUREMENT		
quart	1.101	liters
peck	8.810	liters
bushel	35.239	liters
FUEL CONSUMPTION		
10 miles per gallon = 4.25 kilometers per liter		

Metric to English		
When You Know	Multiple By	To Find
LINEAR MEASUREMENT		
millimeters	.039	inches
meters	3.28	feet
meters	1.09	yards
kilometers	.62	miles
LAND MEASUREMENT		
square millimeters	0.00155	square inches
square meters	10.764	square feet
square meters	1.195	square yards
hectares	2.47	acres
square kilometers	0.386	square miles
LIQUID MEASUREMENT		
milliliters	0.034	fluid ounces
liters	0.529	pint
liters	0.264	quart
liters	2.64	gallons
VOLUME		
cubic meters	35.314	cubic feet
cubic meters	1.307	cubic yards
DRY MEASUREMENT		
liters	1.101	quart
liters	8.810	peck
liters	35.239	bushels
FUEL CONSUMPTION		
10 kilometers per liter = 23.5 miles per gallon		

Conversion Abbreviations

Symbols	Symbols	Symbols
in. = inches	pt. = pint	km = kilometers
ft. = feet	qt. = quart	mm ² = square millimeters
yd. = yards	gal. = gallon	m ² = square meters
mi. = miles	ft ³ = cubic feet	ha = hectares
in ² = square inches	yd ³ = cubic yards	km ² square kilometers
ft ² = square feet	pk. = peck	ml = milliliters
yd ² = square yards	bu. = bushel	l = liters
mi ² = square miles	mm = milliliters	dal = dekaliters (10 liters)
fl oz. = fluid ounces	m = meters	m ³ = cubic meters

Appendix H

Data List for Data Logging On-The-Go

Field No.	No. Characters	Parameter	Value	Description
0	1	Send Prefix	"D"	
1	1-5	Current Target Rate	0 to 99999	(G/Lm, I/Lkm, G/A, G/T, I/h) x 10, (G/Yd ² , I/m ²) x 100
2	1-5	Actual Application Rate	0 to 99999	(G/Lm, I/Lkm, G/A, G/T, I/h) x 10, (G/Yd ² , I/m ²) x 100
3	1-3	Speed	0 to 999	(mph, km/h) x 10
4	1	Pressure	0	Unused
5	1	Flow Rate	0	Unused
6	1-5	Active Section Width	0 to 65535	x 1 inch or x 1000 m
7	1	Section Flags	Bit 0 = Section 1	0 = Switch Off, Section Enable Off or Width = 0
			Bit 1 = Section 2	1 = Switch On, Section Enable On or Width > 0
			Bit 2 = Section 3	
			Bit 3 = Section 4	
			Bit 4 = Section 5	
8	1	Mode Flags	Bit 0 = Console Hold	1 = Hold
			Bit 1 = Remote Hold	1 = Hold
			Bit 2 = PC Hold	1 = Hold
			Bit 3 = Auto	1 = Auto, 0 = Manual
			Bit 4	Unused
			Bit 5 = Blasting	1 = Using Blast Target, 0 = Normal
9	1	Status Flags	Bit 0 = Rate Warning	Application Error > 10%
			Bit 1 = Bad Cal	EEPROM Checksum Failed
			Bit 2 = Tank Empty Alarm	

Appendix I

Totals Data List for Downloading Accumulated Data

Field No.	No. Characters	Parameters	Value	Description
0	1	Send Prefix	t (ASCII 74 ₁₆)	T request response
1	1-3	Vehicle Number	0 to 255	Vehicle Identification Number
2	8	Date (of download)	01/01/06 to 12/31/99	Month/Date/Year
3	5	Time (of download)	00:00 to 23:59	Hour: Minute, 24 hour clock
4	1-7	Area 1	.0 to 99999 or	Lane Miles, Acres, Turfs, Lane km
			.00 to 99999 or	hectares
			0 to 9999000	Yd ² , m ²
5	2-6	Volume 1	.0 to 99999	Gallons or liters
6	2-6	Distance 1	.0 to 99999	Feet, Yards, Miles, meters or kilometers
7	2-4	Average Speed on Area 1	.0 to 99.9	mph or kph
8	2-4	Highest Speed on Area 1	.0 to 99.9	mph or kph
9	8	Date 1 Cleared	01/01/06 to 12/31/99	Month/Date/Year
10	5	Time 1 Cleared	00:00 to 23:59	Hour: Minute, 24 hour clock
11	1-7	Area 2	.0 to 99999 or	Lane Miles, Acres, Turfs, Lane km
			.00 to 99999 or	hectares
			0 to 9999000	Yd ² , m ²
12	2-6	Volume 2	.0 to 99999	Gallons or liters
13	2-6	Distance 2	.0 to 99999	Feet, Yards, Miles, meters or kilometers
14	2-4	Average Speed on Area 2	.0 to 99.9	mph or kph
15	2-4	Highest Speed on Area 2	.0 to 99.9	mph or kph
16	8	Date 2 Cleared	01/01/06 to 12/31/99	Month/Date/Year
17	5	Time 2 Cleared	00:00 to 23:59	Hour: Minute, 24 hour clock
18	1-7	Area 3	0.0 to 99999 or	Lane Miles, Acres, Turfs, Lane km
			0.00 to 99999 or	hectares
			0 to 9999000	Yd ² , m ²
19	2-6	Volume 3	0 to 9999.9	Gallons or liters
20	2-6	Distance 3	.0 to 99999.9	Feet, Yards, Miles, meters or kilometers
21	2-4	Average Speed on Area 3	.0 to 99.9	mph or kph
22	2-4	Highest Speed on Area 3	.0 to 99.9	mph or kph
23	8	Date 3 Cleared	01/01/06 to 12/31/99	Month/Date/Year
24	5	Time 3 Cleared	00:00 to 23:59	Hour: Minute, 24 hour clock
25	1	Units	E (45 ₁₆) or M (4D ₁₆)	E = English, M = metric
26	1	Mode	L (4C ₁₆), A (41 ₁₆)	L = Lane, A = Agriculture
			T (54 ₁₆), D (44 ₁₆)	T = Turf, D = Dust

Where:

T = Turf - 1000 Ft ²	L = Lane	G/T = Gallons/Turf
G/LM = Gallons/Lane Mile	l/Lkm = liters/Lane kilometer	G/A = Gallons/Acre
l/h = Liters/Hectare	G/Yd ² = Gallons/Sq yard	l/m ² = Liters/Sq Meter

Appendix J

Replacement Parts List

ROADMASTER PWM System Components with Part Numbers

The following replacement parts are available from:
Micro-Trak Systems, Inc. • 111 East LeRay Avenue • P. O. Box 99
Eagle Lake, MN 56024 • Toll-Free: 1-888-328-9613

<u>Part Number</u>	<u>Description</u>
01535	Remote RUN/HOLD Sensor Kit
13181*	ROADMASTER PWM Console Mount Kit
14313	10' Branch Cable
14315	15' Battery Cable
14519	RUN/HOLD Foot Switch
17545	ROADMASTER PWM Reference Manual
17546	ROADMASTER PWM Console, PWM
17523	Remote Hold/Blast Cable
17560	Optional Remote BLAST/RUN-HOLD Switch Kit
21778	Run/Hold Switch/Bracket Kit
21779	Power Switch/Bracket Kit

Ground Speed Sensors

<u>Part Number</u>	<u>Description</u>
01410	Astro II w/3-pin MT Base I & II M/P
01425	Astro 5 w/3-pin MT Base I & II M/P
01526	Vansco Radar Speed Sensor w/adapter
01531	Magnetic Wheel Speed Sensor Kit
01533	Magnetic Drive Shaft Speed Sensor Kit

Flowmeters

<u>Part Number</u>	<u>Description</u>
01500	Optional FM500 Flowmeter Kit
01501	Optional FM750GFN Flowmeter Kit
01504	Optional FM750SS Flowmeter Kit
01505	Optional FM 1000 Flowmeter Kit
01506	Optional FM 1500SS Flowmeter Kit
01507	Optional FM 750SS Flowmeter Kit w/Ceramic Ball
01511	Optional FM 2000 P Flowmeter Kit
01512	Optional FM 3000 PSS Flowmeter Kit
01514	Optional FM 10/100 Flowmeter Kit
01515	Optional FM 270 Flowmeter Kit

Optional 2-Pin, 3-Pin and 10-Pin extension cables:

<u>Part No.</u>	<u>M/P 2-Pin</u>	<u>Part No.</u>	<u>M/P 3-Pin</u>
13200	5-foot	13205	5-Foot
13201	10-foot	13206	10-Foot
13202	15-foot	13207	15-Foot
13203	20-foot	13208	20-Foot
13204	25-foot	13209	25-Foot

<u>Part No.</u>	<u>M/P 5/5 10-Pin</u>	<u>Part No.</u>	<u>W/P 3-pin</u>
14363	5-Foot	10450	5-Foot
14316	10-Foot	10449	10-Foot
14317	15-Foot	10876	15-Foot
14364	20-Foot	10829	20-Foot
14365	25-Foot	11462	25-Foot

*The Console Mount Kit is available only as a kit, some parts are not available in individual components.

Parts and design specifications subject to change without notice.

MANUFACTURED IN THE U.S.A. BY:



MICRO-TRAK[®]
SYSTEMS, INC.

111 E. LeRay Avenue

P. O. Box 99

Eagle Lake, MN 56024-0099

Toll-Free: 800-328-9613

Phone: 507-257-3600 • Fax: 507-257-3001

www.micro-trak.com • trakmail@microtrak.com