

RoadMaster™



REFERENCE MANUAL

Standard Version



MICRO-TRAK®
SYSTEMS, INC.

RoadMaster™

Standard Version

REFERENCE MANUAL

The ROADMASTER™ is an electronic control system that can help you operate more cost-effectively by providing the information you need to maintain proper application rates of liquid de-icer and anti-icing chemicals.

The ROADMASTER™ has been designed for easy installation and operation. However, since each installation will vary depending on your equipment, please take time to familiarize yourself with this manual and the actual components before beginning. Following the procedures described in this manual will ensure proper performance and help avoid problems or questions once you are on the road.

This manual is written for the ROADMASTER™. Please read the manual carefully and follow the instructions as they apply to your usage.

If you do encounter a problem that cannot be corrected by reviewing this manual, consult Micro-Trak Systems, Inc. for assistance.



MICRO-TRAK®
SYSTEMS, INC.

P. O. Box 99 • 111 East LeRay Avenue
Eagle Lake, MN 56024-0099

800-328-9613 • 507-257-3600 • Fax: 507-257-3001
www.micro-trak.com • trakmail@micro-trak.com

Copyright © 2013
Printed in the U.S.A.

Micro-Trak® Warranty

Micro-Trak (herein "Seller") warrants to the original purchaser (herein "Buyer") that, if any product or part of the product (herein "part") proves to be defective in material or workmanship, upon inspection and examination by Seller, within one (1) year from the original date-of-purchase, and is returned to Seller with dated proof-of-purchase, transportation prepaid, within thirty (30) days after such defect is discovered, Seller will, at their option and sole discretion, either repair or replace said part, except that the warranty for expendable parts, including but not limited to, light bulbs and batteries shall be thirty (30) days from the original date-of-purchase. Said warranty is valid only when the part has been installed, operated and maintained in strict accordance with the procedures outlined in the manual. Any damage or failure to said part resulting from abuse, misuse, neglect, accidental or improper installation or maintenance, unauthorized modification, use with other products or attributable to acts of God, as determined solely by the Seller, will invalidate the warranty. Said part will not be considered defective if it substantially fulfills the performance specification. Buyer shall be responsible for all maintenance services, if any, all in strict accordance with the procedures outlined in the manual. The warranty does not include labor, installation, replacement parts or repairs, delivery of replacement parts or repairs or time and travel. Said warranty is nontransferable.

THE FOREGOING WARRANTY IS EXCLUSIVE AND IN LIEU OF ALL OTHER WARRANTIES OF MERCHANTABILITY, FITNESS FOR PURPOSE AND OF ANY OTHER TYPE, WHETHER EXPRESS OR IMPLIED. The Seller's liability, whether in contract, in tort, under any warranty, in negligence or otherwise, shall not exceed the return of the amount of the purchase price paid by the Buyer, and under no circumstance shall the Seller be liable for special, indirect or consequential damages. Seller neither assumes nor authorizes anyone to assume for it any other obligation or liability in connection with said part. No action, regardless of form, arising out of the transactions under this agreement may be brought by the Buyer more than one (1) year after the cause of action has occurred.

Seller agrees to extend the term of the foregoing warranty period should the Buyer return completed warranty registration information, with dated proof-of-purchase, to the Seller within one (1) year from the original date-of-purchase. All conditions and limitations of said foregoing warranty, except the term of said foregoing warranty, shall apply. Said term shall be extended to a total of three (3) years from the original date-of purchase on display consoles and network communication modules, as defined by Seller, and said term shall be extended to a total of two (2) years from the original date-of-purchase on all other parts, except that the warranty for expendable parts, including but not limited to, light bulbs and batteries shall be thirty (30) days from the original date-of-purchase, and except that the warranty for parts manufactured by someone other than the Seller, including but not limited to, shut-off and control valves, DGPS receivers, memory cards and drives, mapping software, flowmeters and pressure sensors shall be one (1) year from the original date-of-purchase.

Units under warranty should be sent prepaid, with dated proof-of-purchase, within 30 days of discovering defect, to the address below:

MAIL AND UPS:

**Micro-Trak Systems, Inc.
Attn: Service Department
111 East LeRay Avenue
Eagle Lake, MN 56024-0099**

Extended Warranty Option

It's simple! Just complete the registration for this product **ONLINE** at www.micro-trak.com and we'll extend your warranty for up to three years*, at no additional charge.

Registration information is for internal use only.

* Some limitations apply. See warranty statement for details.

Table of Contents

Warranty.....	3
Table of Contents	4-5
Component Parts and Assembly Hardware.....	6
ROADMASTER™ System Diagram.....	7
ROADMASTER™ Wiring Diagram.....	8
Installation.....	9-12
Mounting the Display Console and Switches.....	9
Electrical Installation	10
ROADMASTER™ Section Connections.....	10
Speed Sensor Installation.....	11
Mounting and Plumbing Flowmeter.....	11
Installing Flow Sensor Cable.....	12
Installing Servo Valve.....	12
Installing a Tank Level Switch.....	12
Installing External Blast Switch.....	12
ROADMASTER™ Console Functions	13
Calibration	14-17
Entering Calibration Values.....	14-16
Radar or GPS Speed Sensor Calibration Table.....	16
Exiting Calibration.....	16
Default Calibration Values Table	16
Calibration Log Sheet	17
“Special” Calibration.....	18-21
Entering “Special” Calibration Values	18
“Special Cal” Pages Index	18
Default “Special” Calibration Values Table.....	18
“Special” Calibration Page One	19
“Special” Calibration Page Two.....	20
“Special” Calibration Page Three	21
Operation.....	22-26
Console Switches & Buttons.....	22-23
Rotary Switch Positions.....	23-24
Resetting System Counters.....	25
Pre-Application System Checkout	26

Table of Contents (cont.)

Troubleshooting	27-29
Messages/Warnings.....	27
Console Appears Dead.....	28
Speed is Always Zero or Erratic.....	28
Area Count is Inaccurate.....	28
Distance Count is Inaccurate.....	28
No Readout of Gallons (liters) or Gallons per Minute (liters per minute).....	28
Total Liquid Used is Inaccurate.....	28
Electrical Interference.....	28
Displayed Measurements Do Not Make Sense.....	28
Display Reads "99999".....	28
Checking Individual Components.....	29
Console Inputs.....	29
Harness.....	29
Magnetic Hall-Effect Speed and Flow Sensors.....	29
Astro II and Astro 5.....	29
Vansco Radar Speed Sensor.....	29
Electric Section Valves.....	29
Plumbing.....	29
Plumbing Guidelines	30
General.....	30
Pump Inlet.....	30
Flowmeter.....	30
Pump.....	30
Appendices	31-43
Appendix A: Optional Speed Sensor Mounting Installation.....	32-34
Appendix B: Calibrating if Using a Magnetic Speed Sensor.....	35
Appendix C: Fine Tuning Speed/Distance Calibration Value.....	36
Appendix D: Fine Tuning Flowmeter Calibration Value.....	37
Appendix E: Flowmeter Cleaning.....	38
Appendix F: Radar "Y" Adapter Cables.....	39
Appendix G: Conversion Chart.....	40
Appendix H: Data List for Data Logging On-The-Go.....	41
Appendix I: Totals Data List for Downloading Accumulated Data.....	42
Appendix J: Replacement Parts List.....	43

Component Parts and Assembly Hardware

Before beginning installation, check the carton contents for the following items:



ROADMASTER™ Console
P/N 17514

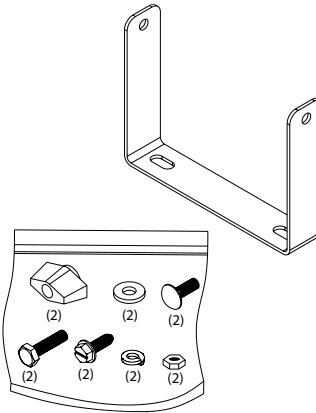

Console Mount Kit
P/N 13181

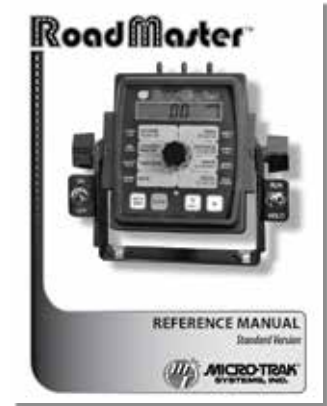

Reference Manual
P/N 17544

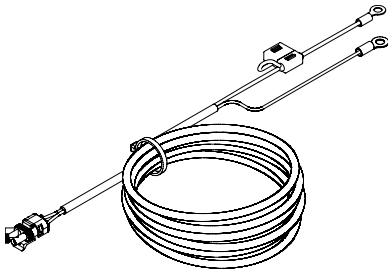

15' Battery Cable with Fuse Holder &
Ring Terminals P/N 14315



10' 10-pin M/P Extension Cable
P/N 14316

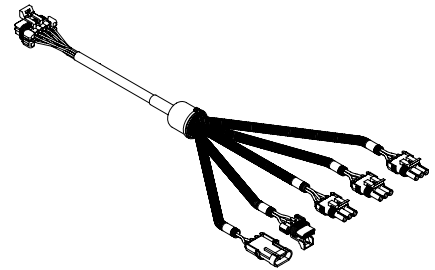

10' Flow/Control/Section Harness
P/N 14313



Optional Blast/Run/Hold
Remote Switch Box
P/N 17560

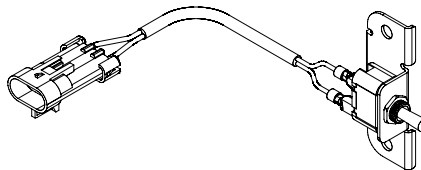

Kit, Run/Hold Switch
P/N 14361

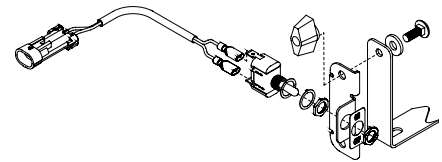

Kit, Power Switch
P/N 14360

ROADMASTER™ System Diagram

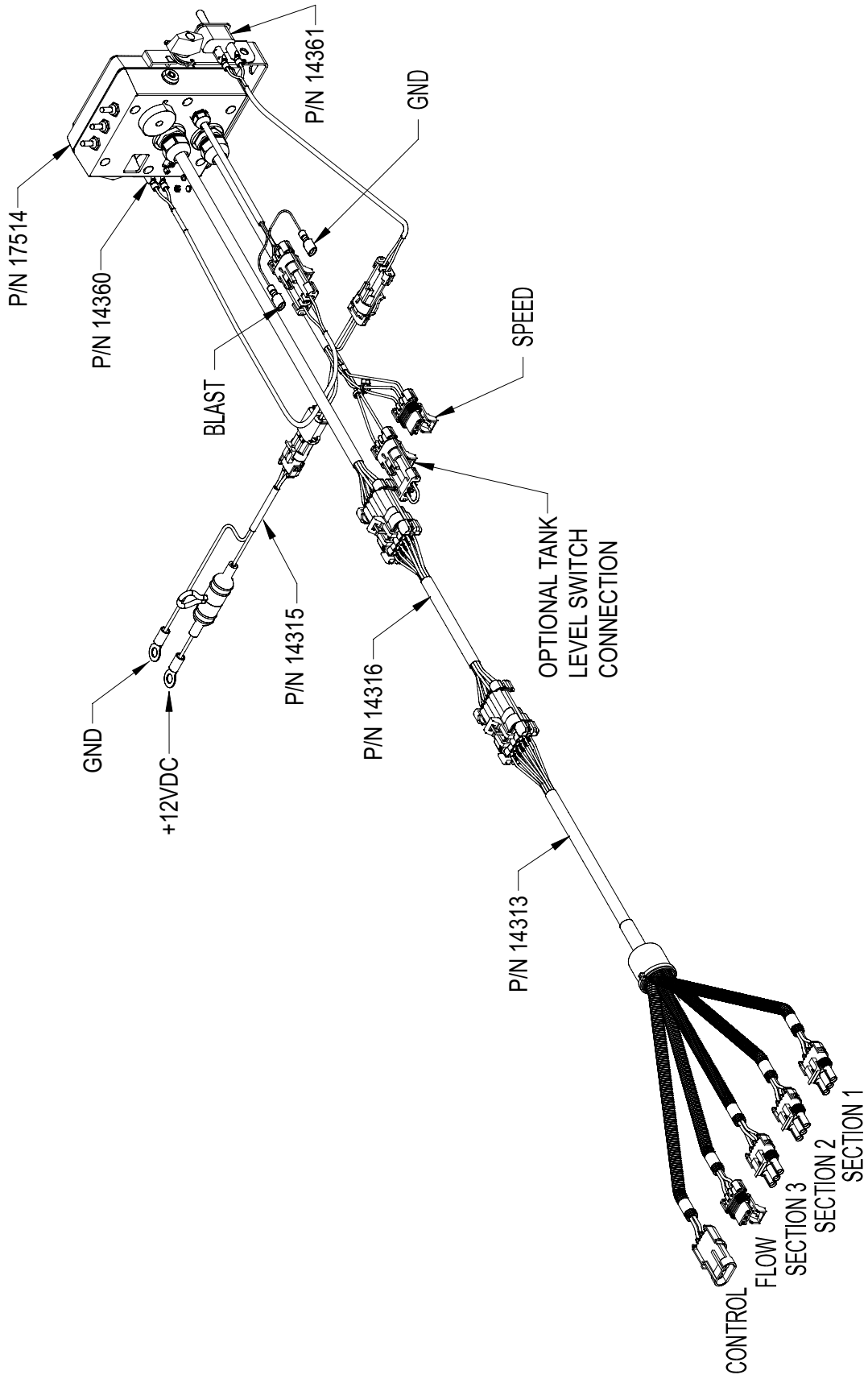

ROADMASTER™ Wiring Diagram

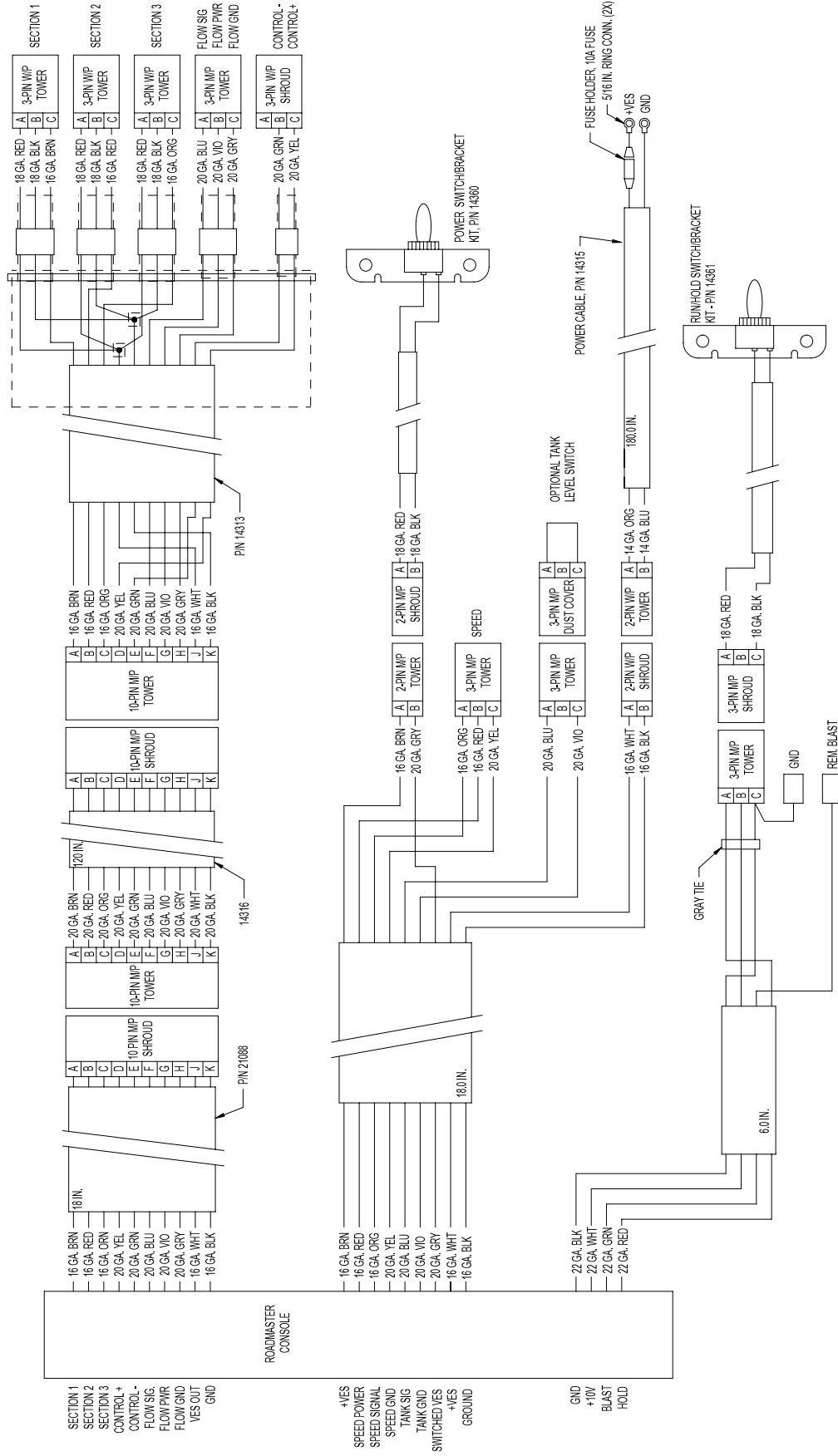

Installation

Mounting the Display Console & Switches

Select a mounting location that is convenient to reach and highly visible to the operator. DO NOT INSTALL IN A POSITION THAT OBSTRUCTS THE VIEW OF THE ROAD OR WORK AREA. Whenever possible, avoid locations that expose the console to direct sunlight, high temperature, strong chemicals or rain.

Place the mounting bracket in the selected location, mark holes, drill 1/4" (7mm) holes and mount bracket with bolts, lock washers and nuts provided. (Use self-tapping screws if not practical to use bolts.) *See Illustration 1.*

Put rubber washers on carriage bolts and put the bolts through the bracket holes from the inside out. Place console over carriage bolt heads.

Install the switch brackets over the carriage bolts and alongside the console bracket. Install the mount knobs on the carriage bolts and tighten to secure the console and switch brackets in place. *See Illustrations 2 & 3.*

Install the switches in the brackets, making sure that the "ON" position is oriented up. Attach the quick disconnects on the switch harnesses to the switches (see wiring diagram). Then install the switch harness connectors into the mating connectors on the console harness. Typically the power On/Off switch (Kit 14360) is mounted on the left and the Run/Hold switch (Kit 14361) is mounted on the right.

Console On/Off Switch - P/N 14360

Illustration 2

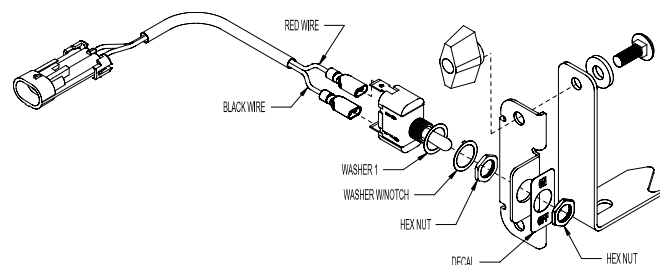

Console Run/Hold Switch - P/N 14361

Illustration 3

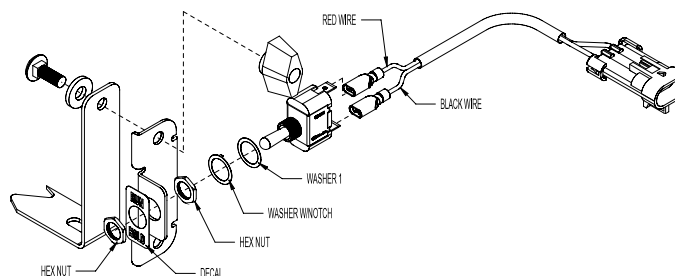

Console Mount Kit - P/N 13181

Illustration 1

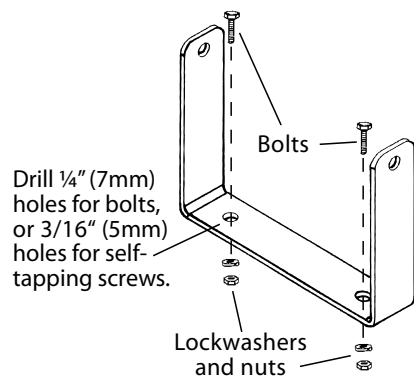

Installation (cont.)

Electrical Installation

NOTE: The ROADMASTER™ must be connected to a 12-volt DC negative ground electrical system.

POWER/BATTERY CONNECTION

Locate the power cable for the ROADMASTER™ and route to the battery. When routing cable to console, avoid areas where the cable may be subjected to abrasion or excessive heat. Attach the BLUE wire (ground) to a screw or bolt on the equipment frame. *See Illustration.* Be sure there is clean metal-to-metal contact. Connect the ORANGE wire to the positive battery terminal.

Connect the power to the ROADMASTER™ console by plugging the 2-pin W/P tower on the power cable into the 2-pin W/P shroud of the display console.

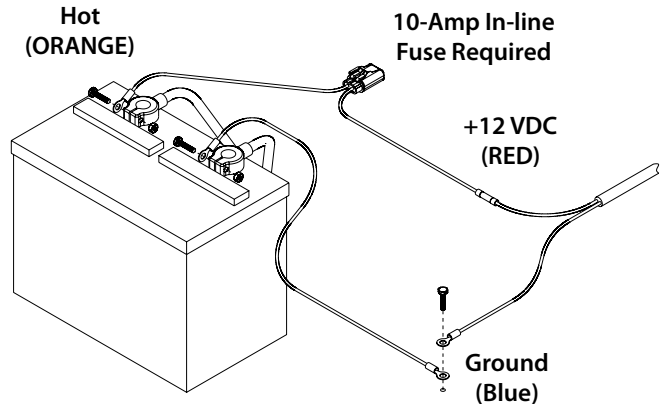

RoadMaster™ Section Connections

Section SHUT-OFF VALVES

Locate labeled section valve connectors on P/N 14313 10' Flow/Control/Section Harness . Connect these connectors to corresponding valves. Apply silicone grease to valve connections to avoid corrosion.

NOTE: When using the system in LANE MODE, Section 2 defines the Lane Width. If only using one section valve, connect the Section 2 connector to it and use the Section 2 (center) switch on the console to control it.

10' Flow/Control/Section Harness wiring P/N 14313

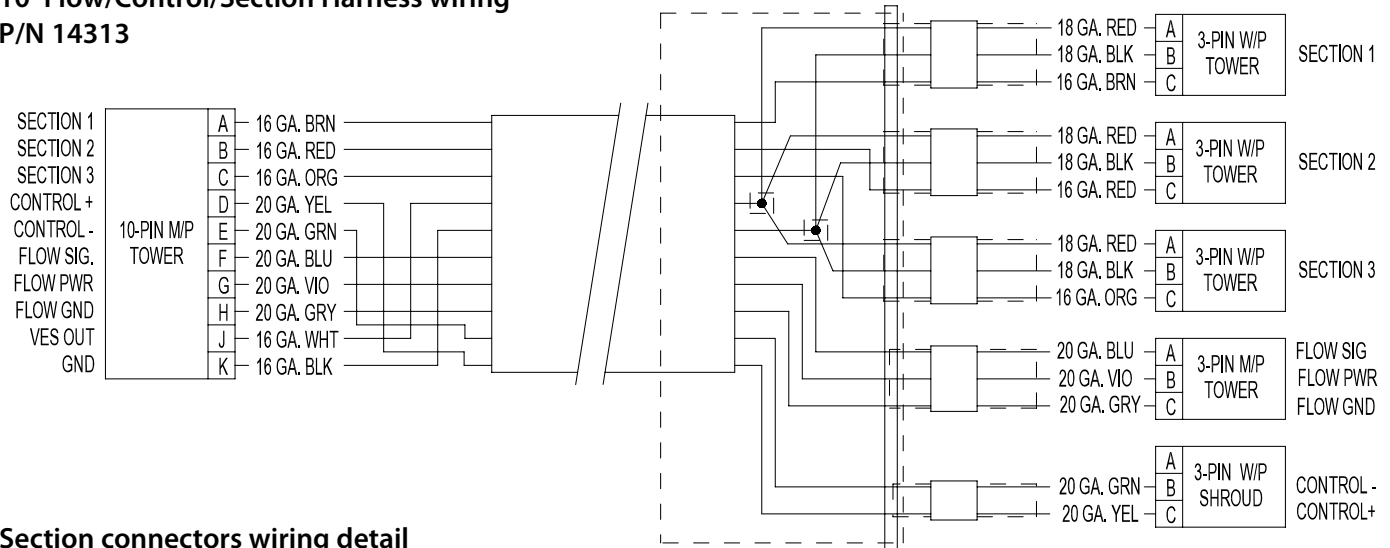

Section connectors wiring detail

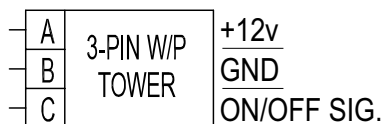

Installation (cont.)

Speed Sensor Installation

Installation Note: The harness provides local connection for the speed sensor. For speed sensor installations on implements, add 3-pin extension cables as required.

Please Note: If you have purchased an Astro GPS Speed Sensor, a Vansco radar or other radar or GPS speed sensor, install the Astro, the Vansco or other radar as described in the instructions included with the unit. You may need an adapter cable to connect to radar or GPS Speed Sensor, see Appendix F.

NOTE: If using a Micro-Trak Magnetic Speed Sensor kit, See Appendix A.



SPEED SENSOR OPTIONS

In addition to the standard Hall-effect magnetic speed sensor, the ROADMASTER™ may be interfaced with a variety of other speed sensing equipment. Several options are listed below.

ASTRO SERIES OR OTHER GPS SPEED SENSOR INTERFACES

The ROADMASTER™ may also be used with most GPS speed sensors that output a pulsed signal, such as the Micro-Trak Astro 5, SkyTrak or Dickey-John GPS speed sensors. An adapter cable may be required.

VANSCO™ RADAR SPEED SENSOR

The Vansco radar speed sensor uses a microwave (radar) signal to deliver a reliable, accurate speed signal for electronic equipment. It features state-of-the-art electronic design/manufacturing, rugged aluminum housing and complete testing and certification.

RADAR INTERFACE

The ROADMASTER™ may also be interfaced with most popular radar ground speed sensors. An adapter cable is required for proper interface.

SEE APPENDIX F FOR LIST OF ADAPTER CABLES FOR RADAR.

Mounting and Plumbing Flowmeter

The flowmeter must be installed in the main line after any strainers, return lines, or valves. Securely mount flowmeter in an area away from intense vibration. A vertical installation with flow entering the bottom is preferred, especially at rates below 5 gallons per minute. Other orientations are sufficient providing the flowmeter remains full of fluid. To avoid erratic flow readings allow a minimum of 6" of straight tubing at the flowmeter input and output. If installation constraints don't allow this keep bends as gentle as possible. Micro-Trak flow meters are bidirectional (exception: green plastic turbine and mag flowmeters are one direction only). Flipping the flowmeter periodically (black nylon and stainless steel Micro-Trak manufactured models) to reverse the flow will greatly extend the life of the flowmeter by evening out bearing wear.

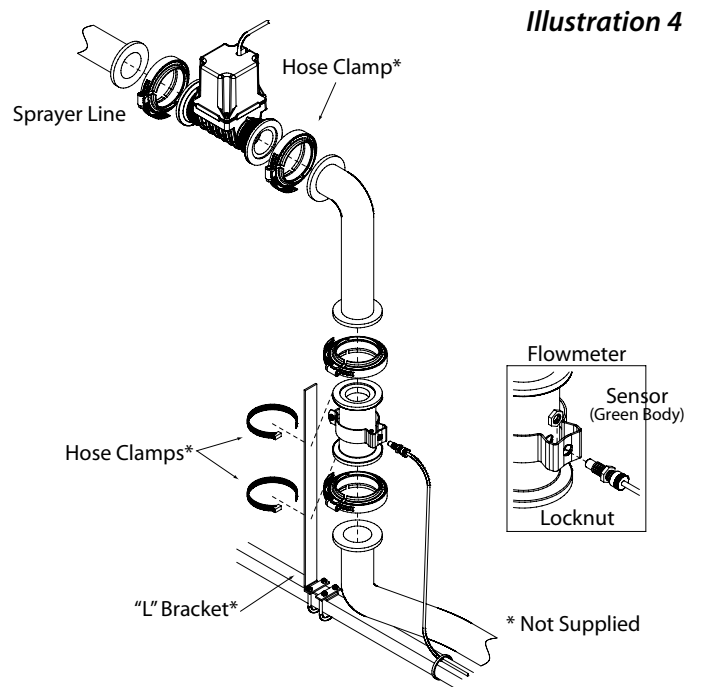

Installation (cont.)

Installing Flow Sensor Cable

With flowmeter in place, install the flow sensor cable.

The flow sensor cable has a GREEN sensor body and mates with the 3-pin M/P connector labeled FLOW on the FLOW/CONTROL/SECTION harness.

Turbine Flowmeters w/bracket mount

Spin the jam nut on sensor threaded housing until it stops, then insert threaded portion of sensor through bracket on flowmeter. Place second jam nut under bracket, hold and turn sensor into second nut. Turn sensor until it touches the flowmeter body, back it off 1/4 turn, then tighten both jam nuts to lock sensor in place.

Turbine Flowmeters w/cast housing

Spin the jam nut on sensor threaded housing until it stops. Insert threaded portion of sensor into threaded hole on flowmeter. Gently tighten sensor until it touches the flowmeter body, back it off 1/4 turn, then tighten jam nut to lock sensor in place.

Last, route the flow sensor cable to meet the extension cable from the main harness flow connector marked with FLOW label. Align connectors and press firmly together until locking tab clicks into place. Secure cable with ties provided.

NOTE: Sensors with GREEN bodies can be used for either SPEED or FLOW.

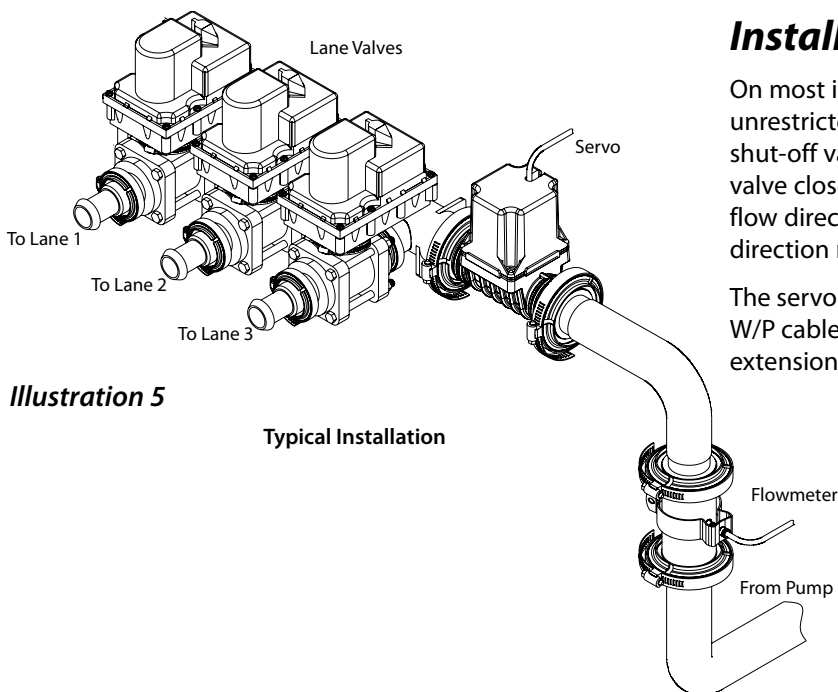

Illustration 5

Typical Installation

Installing Servo Valve

On most installations, the servo valve installs in the main unrestricted spray line, between the flowmeter and the lane shut-off valves. It is not recommended to install the servo valve closer than 12" to the flowmeter. The servo valve has a flow direction decal on it. Make certain that the actual flow direction matches the decal on the servo valve.

The servo valve connects directly to the main harness 3-pin W/P cable lead. If more length is required, use a 3-pin W/P extension cable of the appropriate length.

Installing a Tank Empty Switch

A connection (See *Wiring Diagram on Page 8*) is provided for a "Tank Empty" switch. (Not available from Micro-Trak) The switch must be a 2-wire, closed when tank is NOT empty and open when tank IS empty. Remove jumper and add 3-pin extension cables as required to reach the switch.

Installing External BLAST Switch

An optional external **Momentary On** BLAST switch can be connected to the two quick-connect terminals provided on the harness (See *Wiring Diagram on Page 8*). The remote BLAST switch allows the operator to control the BLAST function from a switch mounted on an armrest or other convenient location. An optional switch box that includes the BLAST switch and RUN/HOLD switch is available from Micro-Trak Systems, Inc.

ROADMASTER™ Console Functions

The ROADMASTER™ features a large, easy-to-read liquid crystal display, rotary dial and lighted panel for night use.

Rotary Switch Position Functions

KEYLOCK FUNCTION: When locked allows the user to view calibration values but prevents changes, allows Data Set 1 to be cleared but prevents clearing Data Sets 2 & 3 (Volume, Area, Distance, Average & Highest Velocity).

TANK ALARM: Can be initiated by either the optional Tank Level Switch or the Tank Counter (If Tank Alarm is set in "Special" Calibration).

REMOTE BLAST SWITCH - Optional: The Optional Remote Blast Switch can initiate the BLAST sequence in normal operation, the same as the console BLAST switch.

AUDIBLE ALARM: Alarm will sound for Rate errors over 10%, Tank Level below set point or Tank Empty (from Float input). The alarm can be temporarily shutoff by setting rotary switch to MODE (Alarm Reset) and pressing the RESET button.
Note: Setting ALARM ENABLE to OFF in "Special" Calibration will disable All Audible Alarms.

VOLUME (1) (2) (3): Displays total gallons (liters) of liquid applied. May be reset. SEE NOTE

VOLUME/MINUTE: Displays total gallons (liters) of liquid applied per minute.

TANK LEVEL: Displays gallons (liters) of liquid remaining. If a FILL TANK SIZE has been set to a value in Calibration, pressing the "+" will make the Tank value jump to FILL TANK SIZE value. The value can be decreased but not increased above the FILL size. If the FILL TANK SIZE is set to Zero, Tank level can be adjusted to any value from 0 to 65,535 using the "+" or "-" (RESET) keys.

RATE: Displays application rate.

WARNING LIGHT: Indicates over or under application of plus or minus 10% from the Target Rate or if the tank is low or minimum flow active. Also lit when in CAL. and Unlocked.

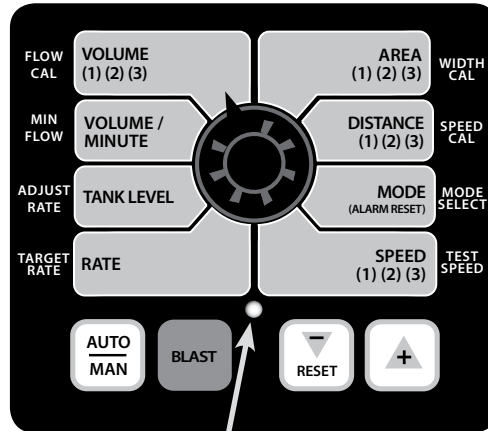

AREA (1) (2) (3): Keeps a running count of the total area worked. May be reset. SEE NOTE

DISTANCE (1) (2) (3): Displays distance traveled. May be reset. SEE NOTE

MODE: Displays selected mode. User selects between Lane, Ag, Dust and Turf Modes of operation. Allows Audible Alarm to be RESET by Pressing the RESET button.

SPEED (1) (2) (3): Displays ground speed in miles per hour (kilometers per hour) or Average & Highest velocity. May be reset. SEE NOTE

NOTE: VOLUME, AREA, DISTANCE & SPEED counters work in sets. If the VOLUME counter 1 is reset, it also resets AREA counter 1, DISTANCE counter 1 and Average & Highest Speed counter 1. This will be the same for resetting any counters in the set.

Calibration Positions

FLOW CAL: Enter the calibration value assigned to your flowmeter (see flowmeter tag.)

MIN FLOW: Enter the minimum flow rate of the application system.

ADJUST RATE: Enter an amount of change for on-the-go adjustments to the target rate.

TARGET RATE: Enter the target application rate.

Calibration Positions

WIDTH CAL: Enter the working width.

SPEED CAL: Enter the speed calibration number in inches (cm) per pulse.

MODE SELECT: Allows the user to change the MODE Select between modes of operation. Lane, Ag, Dust and Turf.

TEST SPEED: Simulates ground speed for system checkout.

Soft Key Functions



Key which changes operation from automatic control to manual. (If Manual Control is enabled, see page 21).



Multi-function key:

- Used to enter & exit the calibration and "special" calibration modes.
 - Used to initiate BLAST sequence in normal operations
 - Overrides flowmeter input in case of an Emergency Stop.
 - Toggles between SPEED CAL and Distance traveled while fine tuning the SPEED CAL factor or between FLOW CAL and Volume when fine tuning the Flow Cal factor.
- See Appendices C & D.



PROGRAM KEYS: In normal operating modes, used to increase/decrease application rate. With Rotary Switch in the SPEED position, RESET key is used to display Average and Maximum Speed. In Volume, Area, Distance or Speed, the "+" key selects counter set.

- RESET: When in Hold and not in CAL, clears the selected counter **set** when held for two seconds. When rotary switch is in the MODE position, Resets Audible Alarm.
- When in CAL, the "+" key increases and the "-" decreases the calibration value displayed.

Calibration

Entering Calibration Values

To enter or change any of the system's calibration values, you must enter calibration.

NOTE: UNITS (English or Metric) must be set in "Special" Calibrate before any other CALIBRATE or "SPECIAL" CALIBRATE values.

CALIBRATION PROCEDURE:

1. Turn the sections OFF or put the system in HOLD.
2. Hold the BLAST key for 1 second. The CAL icon will be visible and calibration values can be viewed and edited.
3. Select calibration position with rotary selector. Calibration positions are identified by the WHITE labeling on each side of the rotary selector.
4. Edit calibration values by using the "+" and "-" buttons on the front panel. Switch between calibration positions as needed. (See CALIBRATION SEQUENCE section for recommended sequence)
5. Hold BLAST key for 1second to save changes and exit calibration mode. The CAL icon will disappear and operations can resume. If you do not wish to save your changes, reboot console without pressing BLAST - original values will return.

If the Console is *unlocked*, the Warning LED will also turn on and any of the CALIBRATE values can be adjusted.

If the Console is *locked*, the Warning LED will not turn on and the CALIBRATE (except TEST SPEED) values can only be viewed and cannot be adjusted. TEST SPEED is active whether locked or unlocked.

Illustration 6

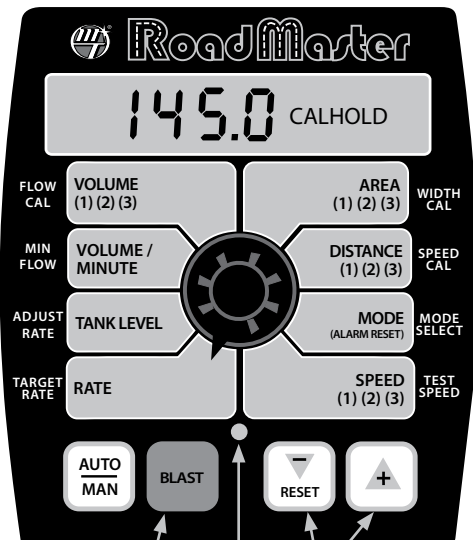

Press to enter or exit calibration mode.

Press to increase or decrease values.

Red warning light will be lit when in CAL and unlocked.

CALIBRATION SEQUENCE

Once in calibration mode, you may change any one, all, or none of the values, in any order, but it is very important to set **MODE first**. Mode Select defines the unit of measurement for all system calculations.

Note: TEST SPEED is NOT a calibration setting. It simulates vehicle speed during Pre-Application System Checkout. This procedure is described on page 26.

MODE SELECT: MODE SELECT allows the user to change the MODE. Pressing the "+" or "-" (reset) will toggle



MODE (ALARM RESET) MODE SELECT

between Lane, Ag, Dust and Turf (except in Metric) MODE and the display will show LAnE, Ag, dUST and turF.

DEFINITIONS OF LANE, AG, DUST AND TURF MODES:

LANE: Used for Highway Maintenance Applications where Area is accumulated in Units of Lane Miles (Lane Km). Distance is in Units of Miles (Km) and Application Rate is in amount of liquid per Lane Mile (Lane Km).

AGRICULTURAL: Mainly used for roadside spraying, where Area is in acres (hectares), Distance is in feet (meters) and Application Rates are in Gallons/Acre (liters/meter²).

DUST CONTROL: Used for controlling suspended particulates, where Area is in square yards (square meters), Distance is in yards (meters) and Application Rates are in Gallons/Yard² (liters/meter²).

TURF (English Only): Where Area is in 1000 square feet, Distance is in feet and Application Rates are in Gallons/1000 feet².

NOTE: A Mode change CLEARS the counters if Calibration is exited correctly. If power to the console is turned off before exiting Calibration, the counters are NOT cleared.

TARGET RATE: Selecting TARGET RATE (in English) displays the desired application rate in these units:

LANE mode - Gallons per Lane Mile

AG mode - Gallons per Acre

DUST mode - Gallons

per Sq. Yard

TURF mode - Gal- lons per 1000 Sq. Feet

TARGET RATE RATE



Selecting TARGET RATE (in Metric) displays the desired application rate in Liters/Lane Km for LANE mode, Liters/Hectare for AG Mode and Liters/Meters² for DUST mode. TURF mode does not apply to Metric settings. This is the application rate that the console will lock onto when operating in AUTO. The Warning LED will flash and Audible Alarm will sound if enabled whenever the actual application rate is more than 10% from TARGET RATE.

Calibration (cont.)

Entering Calibration Values (cont.)

ADJUST RATE: In AUTO control with RATE selected, pressing "+" or "-" will change the TARGET RATE by the amount entered for ADJUST RATE. This allows the operator to make changes to the TARGET RATE quickly. To disable this feature, simply enter "0" for a value.



MIN FLOW: The purpose of this calibration setting is to prevent the system from applying below the recommended minimum flow rate for the nozzles. Enter the minimum flow rate in gallons per minute (liters per minute) based on the nozzles being used, for the entire section width of the applicator. DO NOT enter the target flow of your spray application. For example: If the minimum flow rate for the nozzle you are using is .22 GPM at their minimum recommended pressure and your section has 20 nozzles, enter 4.4 as the MIN FLOW value (.22 x 20 = 4.4). The system WILL NOT apply at a rate lower than this value when spraying in AUTO. The Warning LED will FLASH whenever the system is applying at Minimum Flow Rate but the Audible Alarm will not sound. This value should be checked/changed for each different nozzle that you use.



FLOW CAL: This position is used to calibrate the flow meter for accurate liquid measurement. Enter the Micro-Trak liquid cal number printed on the flowmeter tag (See Illustration 7) The Flow Cal number should not be changed during operation because a change in the Flow Cal number will also change some counter values.

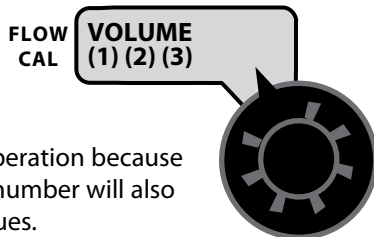
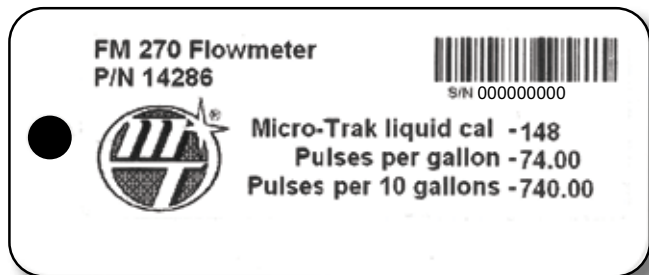
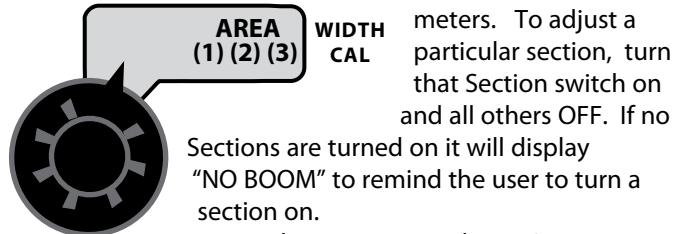

Illustration 7



NOTE: Your ROADMASTER™ flowmeter has been tested at the factory and assigned a "FLOW CAL" value to make it operate properly with the RoadMaster™ console. This number is printed on the white plastic tag attached to the flowmeter. See Illustration 7. In the illustration example, the liquid calibration number is "148". This is a starting point only. If your spray solution has a specific gravity or viscosity that is different than water, flowmeter calibration should be done for the specific solution (please refer to Fine-Tuning Flowmeter Calibration in Appendix D on page 36.)

WIDTH CAL: Displays the Section WIDTH in inches for the Section selected (Unused Section must be set to zero). The total width (sum of all Section widths) must not exceed 65,535 inches or 65.535 meters.



To adjust a particular section, turn that Section switch on and all others OFF. If no Sections are turned on it will display "NO BOOM" to remind the user to turn a section on.
 Note: The system must be in RUN to display section numbers. Repeat this procedure for each section. Enter a value of "0" (.000) for any unused sections. Your "working" width per section will be the number of nozzles on the section times the nozzle spacing in inches (meters). For example, if you have 7 nozzles spaced at 20 inches, the working width of the section is 140 inches.

NOTE: ROADMASTER™ consoles are equipped with 3 Section switches. In Lane Mode the CENTER Section switch is always the PRIMARY Section and is used to define the "LANE WIDTH". Ag, Dust or Turf Modes can use any Section switch. If the operator is only using ONE Section it must be the Primary Section.

CAUTION: If spray lines are pressurized, nozzles may spray during WIDTH calibration (below).

NOTE: When in Lane Mode, a Lane Mile/kilometer is defined as the area in a swath equal to the Center (Primary) Section width, that is one (1) mile/km long. The user defines a Lane Mile/kilometer by changing the Center Section width. For example, if the Center (Primary) Section Width is set to 12 feet, and the Left and Right Sections are set to three feet, one mile traveled will result in an Area of 1.5 Lane Miles covered.

Calibration (cont.)

Entering Calibration Values (cont.)

SPEED CAL: This position is used to calibrate the speed sensor for accurate speed and distance measurement.

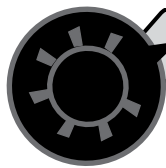

DISTANCE
(1) (2) (3)

SPEED
CAL

When this position is selected, the display will show the SPEED CAL value along with "CAL" on the display. In English units, the SPEED CAL number is displayed in inches, in metric it is displayed in centimeters. The SPEED CAL is factory-calibrated for use with an Astro GPS Speed Sensor. See the table below for SPEED CAL numbers for other types of GPS speed sensor or radars. *See Appendix B for procedure to calibrate if using a Magnetic Speed Sensor. See Appendix C for Fine-Tuning Speed Calibration.*

TEST SPEED: Choose the value to be used for simulating speed for performing Pre-application System checkout. The console will use this speed for simulating spraying operations. The test speed value is only used while in calibration mode. Once CAL is exited, the Test Speed value is reset to zero.

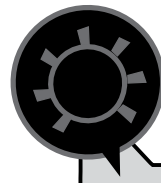

SPEED
(1) (2) (3)

TEST
SPEED

Please refer to Pre-application System Checkout on page 26 for details.

Radar or GPS Speed Sensor Calibration

Radars	English	Metric
Vansco	.150	.38
Raven	.148	.38
Magnavox	.154	.39
Dickey-john (Radar Velocity Sensor II)	.149	.38
	.199	.50
	.319	.81
	.518	1.32
GPS Speed	English	Metric
Astro II & 5	.189	.48
SkyTrak	.150	.38
Dickey-john	.210	.53
John Deere (In-Cab Speed Signal)	.197	.50

EXITING CALIBRATION: Upon completion of the calibration process, exit calibration. Basic calibration is now complete. Please refer to Pre-application System Checkout section to confirm overall system performance.

Default Calibration Values

Cal Factor	English	Metric
Mode	Lane	Lane
Speed Cal	.189	.48
Flow Cal	145.0	145.0
Min Flow	0.0 (Off)	0.0 (Off)
Target Rate	20.0 Gal/Lane Mile	45.0 liters/Ln km
Adjust Rate	1.0 Gal/Lane Mile	1.0 liters/Ln km
Section 1 width	0	0
Section 2 width	96 in	2.438 meters
Section 3 width	0	0

Calibration (cont.)
Calibration Log Sheet

Serial No. _____

Min Flow: _____

Adjust Rate: _____

Target Rate: _____

Width Cal (Section Width):	<u>left</u>	<u>center</u>	<u>right</u>
	_____	_____	_____
	_____	_____	_____
	_____	_____	_____

Speed Cal: _____

Mode Sel: _____

Test Speed: _____

Comments: _____

“Special” Calibration

Entering Calibration Values

NOTE: UNITS (English or Metric) must be set in “Special” Calibrate before any other CALIBRATE or “SPECIAL” CALIBRATE values.

There are three (3) pages of “SPECIAL” CALIBRATE values, total of 18 used for Standard Drive, selected by the rotary switch and BLAST key. To enter Special Cal, put the system in HOLD, turn the console power OFF, press and hold the BLAST button while turning console ON. The console will display SPEC for 2 seconds to show that the console is in the Special Calibration mode. Release the BLAST button.

If the Console is unlocked, the Warning LED will also turn on and any of the “Special” CALIBRATE values can be adjusted.

If the Console is locked, the Warning LED will not turn on and the “Special” CALIBRATE values can only be viewed and cannot be adjusted.

NOTE: Press and release the BLAST key to alternate between SPECIAL CAL pages 1, 2, and 3 (Number icons indicate page).

The desired Special Calibration Parameter(s) can then be accessed with the rotary switch. To exit Special Calibration, press and hold the BLAST button for 1 second. The console will save any changes and revert to normal operation.

To exit without saving changes, simply turn the console power off without pressing BLAST.

Special Calibration

Special Cal Page 3	Special Cal Page 2	Special Cal Page 1
Manual Enable	Minimum Alarm Speed	Fill Tank Size
	Start Time	Tank Alarm Set Point
	Auto Shutoff	Blast Duration
Alarm Enable	Auto Delay Time	Blast Target Rate

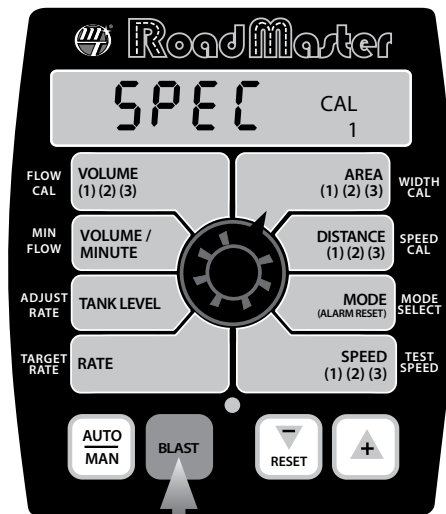

Special Cal Page 1	Special Cal Page 2	Special Cal Page 3
Units (Eng/Metric)	Set Year	
Vehicle Number	Set Month	
Valve Polarity	Set Date	
Valve Speed	Set Time	

Default “Special” Calibration Values		
“Special” Calibration Factor	English	Metric
Tank Set Point	Off	Off
Fill Tank Size	Off	Off
Control Speed	-1	-1
Vehicle Number	1	1
Blast Target Rate	30 Gal/Lane Mile	65 liters/Lane km
Blast Duration	15 sec	15 sec
Start Time	0 (Off)	0 (Off)
Auto Delay Time	1 sec	1 sec
Valve Polarity	In-Line	In-Line
Auto Shut-Off	Off	Off
Minimum Alarm Speed	0 MPH	0 kph
Manual Control Enable	On	On
Alarm Enable	On	On

“Special” Calibration (cont.)

Entering Calibration Values (cont.)

Page One

NOTE: Changing UNITS will load defaults, so they should always be changed first and then all other CALIBRATE and “SPECIAL” CALIBRATE values may be set.

UNITS (English or Metric):

Selecting the AREA position on page one (1) allows the user to change the UNITS and load defaults. Pressing the “+” or “-” (RESET) keys will toggle between English and Metric UNITS and the display will show En9 or nnEt. NOTE: Trying to select Metric Units in Turf Mode will cause the Error message to be displayed. Defaults will not be loaded until the Rotary Selector is moved away from AREA or the “Special” Cal page is changed or “Special” Cal is exited normally.

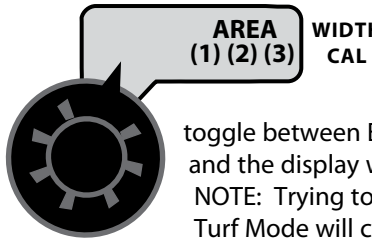

VEHICLE NUMBER:

Selecting the DISTANCE position on page one (1) allows the user to change the VEHICLE NUMBER from 0 to 255 by using the “+” or “-” (Reset) keys. The VEHICLE NUMBER is downloaded with the Total and Configuration data through the serial port.

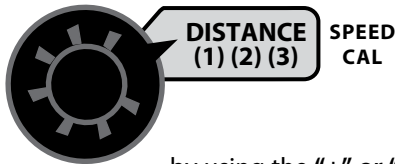

VALVE POLARITY:

Selecting MODE position on page one (1) allows the operator to install the flow control valve in either a By-Pass or In-Line configuration. Pressing the “+” or “-” (reset) key will toggle the display between bYPAS and InLin.



Selecting the SPEED position on page one (1) allows VALVE SPEED to be changed, to adjust system response speed (if required). Pressing the “+” or “-” (Reset) keys will adjust the VALVE SPEED from -4 to 3. Normal setting is -1. NOTE: Use caution

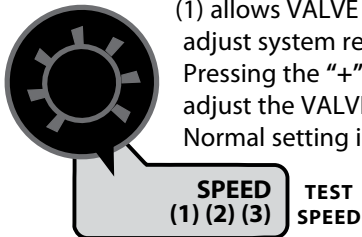

when adjusting the Valve Speed setting. Higher values used with a fast valve may cause system instability (hunting, oscillations).

BLAST TARGET RATE:

Selecting the RATE position on page one (1) allows the user to enter the desired BLAST TARGET RATE. The units and range are identical to the normal TARGET RATE but BLAST TARGET RATE is only used when the BLAST key is pressed.

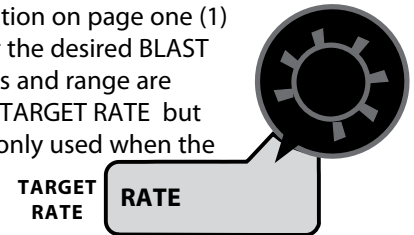

BLAST DURATION:

Selecting the TANK LEVEL position on page one (1) allows the user to enter the desired BLAST DURATION. It can be adjusted from 0 (Off) to 255 seconds.



TANK ALARM SET POINT:

Selecting the VOLUME/ MINUTE position on page one (1) allows a TANK ALARM SET POINT to be entered. When enabled, the Warning LED flashes, the alarm sounds and the display alternates between FILL and normal when Tank volume falls below the Set Point. When set to “Off”, the alarm is disabled.

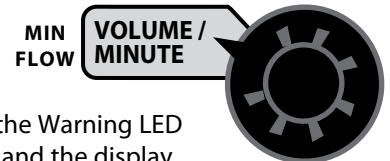

Selecting the VOLUME position on page one (1) allows the user to enter a FILL TANK SIZE which can be toggled to OFF or 1 to 65535 using the “+” or “-” (reset) keys. The FILL TANK SIZE is in gallons in English or liters if in Metric Units. If a FILL TANK SIZE is specified, then pressing “+” while set to the TANK position (in Operation) will set the TANK value to FILL TANK SIZE for quick reloading.

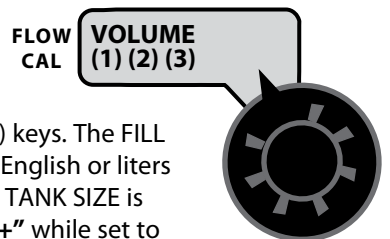

"Special" Calibration (cont.)

Entering Calibration Values (cont.)

Page Two

MINIMUM ALARM SPEED: Selecting the VOLUME position on page two (2) allows adjustment of the MINIMUM ALARM SPEED. Pressing the "+" or "-" (Reset) keys will adjust the MINIMUM ALARM SPEED from 0.1 to 99.9 mph or kph. When the ground speed is below the MINIMUM ALARM SPEED, an Application Rate error will not generate an Audible Alarm. Tank empty and Float alarms are not disabled. Setting the MINIMUM ALARM SPEED to Off will disable the function and allow audible warnings at any speed. This setting can be used to disable nuisance alarms while stopping and starting.

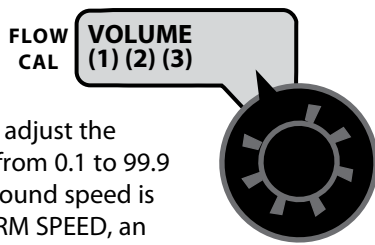

START TIME: Selecting the VOLUME/MINUTE position on page two (2) allows the user to change the START TIME for the control valve. The START TIME can be adjusted from Off to 2.048 seconds. The START TIME runs the Control Valve towards open for the amount of time (seconds) set, when a HOLD to RUN transition occurs. The control valve may be used to stop hydraulic flow and can be the cause of an undesirable delay for the Servo to return to normal operating flow. The START TIME cal value can be used to reduce this delay.



AUTO SHUT OFF: Selecting the TANK LEVEL position on page two (2) allows the user to turn the AUTO SHUT OFF feature On or Off by using the "+" or "-" (Reset) keys. While in AUTO with the AUTO SHUT OFF turned off automatic control will "freeze" the current flow when HOLD is pressed. With the AUTO SHUT OFF ON, the servo valve will run towards closed for 4 seconds each time HOLD is selected or ground speed is stopped. This is useful for stopping flow when using auger or belt delivery systems.



AUTO DELAY TIME: Used to delay adjustment of the servo valve (in AUTO) until section or ON/Off valves have completely opened. Selecting the RATE position on page two (2) allows the user to change the AUTO DELAY TIME by using the "+" or "-" (Reset) keys to vary the delay time from 0 (no delay) to 1, 2, 3 or 4 seconds.

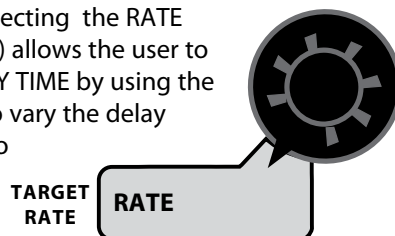

SET YEAR: Selecting the AREA position on page two (2) allows the YEAR to be set from 07 to 99 for 2007 to 2099 using the "+" or "-" (Reset) keys.

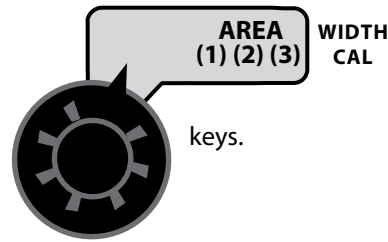

SET MONTH: Selecting the DISTANCE position on page two (2) allows the MONTH to be set from 01 to 12 (Jan to Dec) by using the "+" or "-" (Reset) keys.

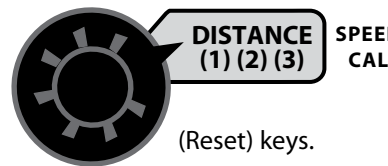

SET DATE: Selecting the MODE position on page two (2) allows the DATE to be set from 01 to 31 by using the "+" or "-" (Reset) keys.

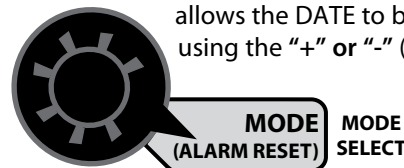

SET TIME: Selecting the SPEED position on page two (2) allows the user to change the TIME from 00:00 to 23:59 by using the "+" or "-" (Reset) keys. The LCD does not include a colon so a decimal point is used.

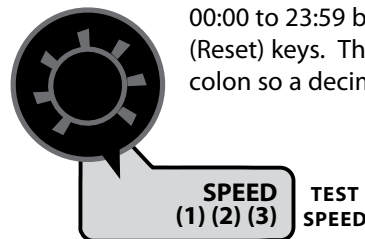

“Special” Calibration (cont.)

Entering Calibration Values (cont.)

Page Three

MANUAL ENABLE: Selecting the VOLUME position on page three (3) allows the user to turn the MANUAL CONTROL ENABLE On or Off by using “+” or “-” (Reset) keys. Setting to Off disables Manual Control. Pressing the AUTO/MANUAL key will not toggle between Auto and manual when set to On.

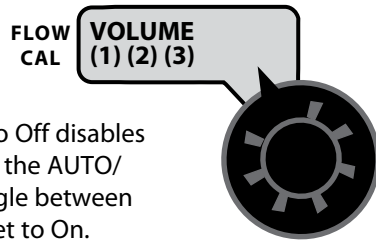

ALARM ENABLE: Selecting the RATE position on page three (3) allows the user to turn the audible ALARM ENABLE On or Off by using the “+” or “-” (Reset) keys. Setting ALARM ENABLE to Off will disable all audible Alarms under all conditions.

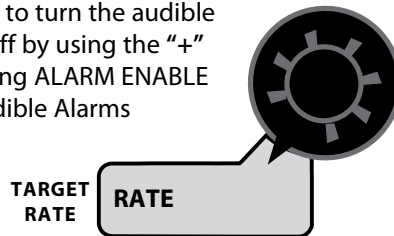

Operation

Console Switches & Buttons

Illustration 8

Make sure your system is properly calibrated before beginning to apply product. We also recommend completion of the Pre Application System Checkout described on page 25 prior to beginning any operations.

The ROADMASTER™ system can be operated in either Manual or Automatic mode. In manual mode, the application rates (See table below for different rates) are set using the “+” and “-” buttons; the application rate will vary depending on the vehicle speed. The manual mode is useful for system set up, spot applications, etc.

To turn on the AUTO mode, press AUTO/MAN button so the AUTO icon appears in upper right portion of display. In automatic mode, the system will maintain the calibrated application rate when the vehicle speed changes, or sections are turned on or off. To operate the system in automatic mode, simply turn on the desired number of sections, place the RUN/HOLD switch in the RUN position and drive. **NOTE: In AUTO mode, the system will not turn the sections on until it has a speed signal.** Use the Section switches, the RUN/HOLD switch or remote RUN/HOLD sensor to Start or Stop application at any time. See the following sections for operation details.

CONSOLE POWER/SYSTEM ON/OFF

When the ROADMASTER™ Console is turned on, except when starting SPECIAL CALIBRATE, the data display will show the Number of Hours it has operated for one (1) second, the Software Part Number (45022) and Software Revision for 1.5 seconds each. Then it will display Std for 1.5 seconds showing that this is a Standard DC Servo Drive Console.

DISPLAY

During normal operation, the console will display information selected by the rotary switch position. Typically the rotary switch will be set on RATE, as shown in *Illustration 8*. With RATE selected, the console will display the Application Rate based on the Mode and Units selected.

RUN/HOLD SWITCH

The RUN/HOLD is the master switch for turning all (active) sections on and off. This function can be done either manually with the included RUN/HOLD switch, or automatically, using the optional RUN/HOLD sensor kit.

AUTO/MAN BUTTON

This button will switch the control status of the system from fully automatic to manual control. Each press of the button will change the status. The display will show the AUTO icon when automatic control mode is active and the MAN icon when manual control mode is active. **NOTE: IF IN “AUTO” MODE AND NO SPEED SIGNAL IS PRESENT, SYSTEM WILL SHUT OFF THE SECTIONS AUTOMATICALLY.**

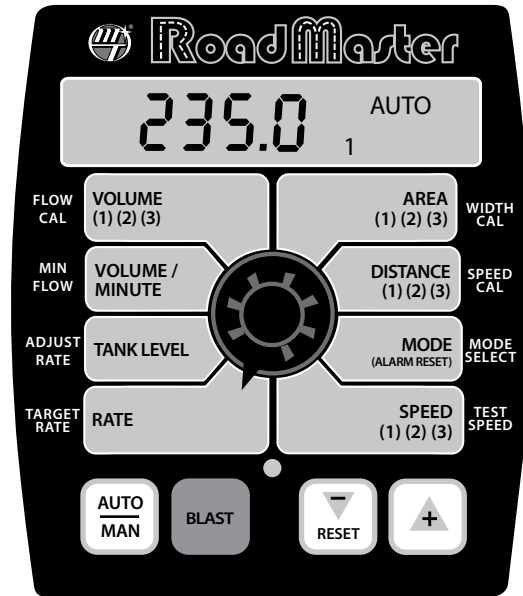

BLAST BUTTON

The BLAST function is intended for spot applications (bridge decks, intersections) at a higher rate. The BLAST calibration functions include BLAST TARGET RATE and BLAST DURATION. When the user presses the **BLAST** switch in Auto, the system will display *BLAST* and output the preset rate for a preset period. The period starts after the BLAST switch is released. If the BLAST switch is pressed again during the reset period, BLAST will be cancelled. When the BLAST is complete, the system returns to normal operations. BLAST will **NOT** function in Manual mode or if the system is in HOLD or stopped.

“+” AND “-” BUTTONS

During normal operation, when automatic “AUTO” control mode is active and the rotary dial is set to RATE, each press of the “+” or “-” buttons will increase or decrease the target application rate by the amount of the calibrated Adjust Rate.

During normal operation, when manual “MAN” control mode is active and the Run/Hold switch is in the RUN position, and Rotary dial is set to RATE or VOLUME/MINUTE, pressing the “+” or “-” buttons will increase or decrease the application rate.

During normal operation, when either automatic or manual mode is active, the RUN/HOLD switch is in the HOLD position and the rotary switch is turned to VOLUME/MINUTE, pressing the “+” or “-” button will increase or decrease the flow rate without having the section valves turned on. This can be useful for system pressure checking.

Operation (cont.)

Console Switches & Buttons (cont.)

SECTION SWITCHES

The system monitors the status of the section switches to determine whether they are ON or OFF. The console accumulates area based on the calibrated section widths. When an individual section is turned OFF, the respective width is subtracted from the total width to accumulate area based on the new active application width. If the rotary switch is in the RATE position, the numbers 1, 2, or 3 on the display will light when their respective section is ON.

NOTE: Most ROADMASTER™ consoles are equipped with 3 Section switches. In Lane Mode the CENTER Section switch is always the PRIMARY Section and is used to define the "LANE WIDTH". Ag, Dust or Turf Modes can use any Section switch. If the operator is only using ONE Section it must be the Primary Section.

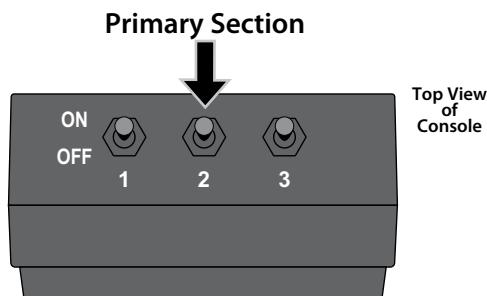

WARNING DEVICE

The console is equipped with a RED warning light. The light will automatically turn on and flash when the actual application is plus or minus 10 percent of the calibrated target rate, or if the TANK alarm feature is activated and the tank is below the set point (display will also flash "FILL" message). If the light stays on while in AUTO, refer to the troubleshooting section of this manual. The RED warning light will also be illuminated when calibration mode is active on the console.

AUDIBLE ALARM

The Audible Alarm is activated for the following conditions:

1. The Tank Level is below minimum level (TANK ALARM SET POINT).
2. Float switch is continuously active for 15 seconds or more.
3. The application Rate Error is greater than 10% for 3 seconds (continuously) after the Auto Delay and Start Up time have completed and the console is in AUTO, and the Ground Speed is above the Alarm Minimum Speed.

EMERGENCY STOP

When in AUTO and in RUN with one or more Sections on and the Speed is greater than zero, if the Flow signal ever stops, the servo will run to fully open. If Flow remains stopped for 5 seconds or more, it will automatically

reduce the flow to a minimum (run Servo closed for 4 seconds). "EStOP" will then display to notify the user of the Emergency Stop. The flow remains off (or reduced) and AUTO control will remain disabled until the system goes into HOLD, power is cycled or CALIBRATE is entered. The Emergency Stop feature helps protect against "chemical spills" or over-application if the Flow signal is lost.

NOTE: VOLUME, AREA, DISTANCE & SPEED counters work in sets, if the VOLUME counter 1 is reset, it also resets AREA counter 1, DISTANCE counter 1 and SPEED counter 1. This will be the same for resetting any counters in the set. Do Not use the "-" button to select counters because the button will clear them. (See Resetting System Counters on page 25). The active set of counters may be reset to zero independent of other sets of system counters.

SERIAL PORT

The DB-9 connector on the back of the console provides access for serial communication. The serial configuration is RS-232, 9600 baud, in 8-N-1 half-duplex format. Data is sent and received in comma-delimited ASCII format. An external device (GPS/Mapping/AVL System) can change the application rate on-the-go and also receives and records data from the ROADMASTER™. *See Appendix H and I for data lists available.*

Rotary Switch Positions

ROTARY SWITCH

During normal operation, you can view any one of eight monitored functions by turning the rotary switch to the appropriate position. The functions that are active during normal operation are the BLUE boxes. Calibration positions are identified by the WHITE labeling on each side of the rotary selector (*Please refer to Calibration section for details*).

VOLUME

Displays the total gallons (liters) applied since the active counter was last reset to zero based on the UNITS selected. Number Icons indicate which set of counters is being displayed. Press the "+" button to select other counter sets.

VOLUME/MINUTE

Displays the gallons (liters) per minute being applied.

TANK LEVEL

Displays amount remaining in the tank. When the tank is refilled, and the tank volume has been entered in Calibration, the TANK LEVEL amount can be reset to a full tank by simply pressing the "+" button for 1 second while the rotary switch is in the TANK level position. The amount in the tank can be decreased by using the "-" button but cannot be increased above the FILL size. If no FILL TANK SIZE is specified, the "+" or "-" (Reset) keys can be used to adjust Tank to any value. The Tank value cannot be changed while in CALIBRATE or "SPECIAL" CALIBRATE mode except while TEST SPEED is set.

Operation (cont.)

Console Switches & Buttons (cont.)

RATE

Displays the Application Rate based on the selected MODE (See Table below).

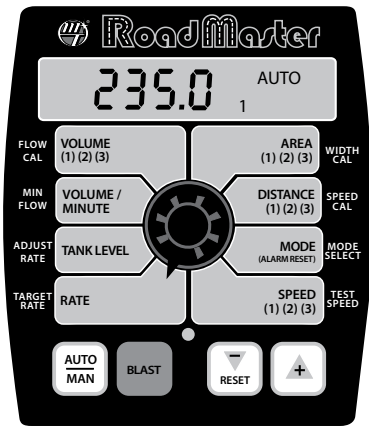

Mode	English	Metric
Lane	Gallons/Lane Mile	liters/Lane km
Ag	Gallons/Acre	liters/hectares
Dust	Gallons/Yards ²	liters/meters ²
Turf	Gallons/Turf	n/a

AREA

Displays the area covered since the counter was last reset to zero based on the MODE selected. The area counters do not accumulate area when the console is in HOLD or if all sections are turned OFF. Number Icons indicate which set of counters is being displayed. Press the "+" button to select other counter sets.

AREA is displayed in the following units based on UNITS and MODE

Mode	English	Metric
Lane	Lane Miles	Lane km
Ag	Acres	hectares
Dust	Yards ²	meters ²
Turf	1000 Feet ² (Turf)	n/a

DISTANCE: Displays the distance driven since the counter was last reset to zero based on the MODE Selected. This counter does not accumulate when the console is in HOLD or all Sections are off. Number Icons indicate which set of counters is being displayed. Press the "+" button to select other counter sets.

DISTANCE traveled is displayed in the following units based on UNITS and MODE

Mode	English	Metric
Lane	Miles	Kilometers
Ag	Feet	Meters
Dust	Yards	Meters
Turf	Feet	n/a

MODE

Displays Current Mode (Lane, Ag, Dust and Turf). Note: Turf mode is not available in Metric Units.

SPEED

Displays the ground speed in miles (kilometers) per hour. When the operator selects SPEED, the Current Velocity will be computed and displayed in 0.1 increments from 0 to 999.9 mph or kph. In the SPEED position, the Number Icons indicate which data set is selected and changes each time the "+" button is pressed. If the user presses the "-" (RESET) key the display will change from Current Velocity to display the Average Velocity (for the selected data set) for 2 seconds. The display will then display the Highest Velocity for 2 seconds and return to display Current Velocity. The Left most digit will display "A" for Average and "H" for Highest when the average and highest speed is being displayed. Speed will continue to operate while in HOLD or all nonzero Sections are off, if a speed signal is still present. Average and Highest will NOT be changed while in HOLD. Illustration 9 shows the Speed in Data Set 1 and that the "-" (RESET) key has been pressed to show the Highest (H) speed.

Illustration 9

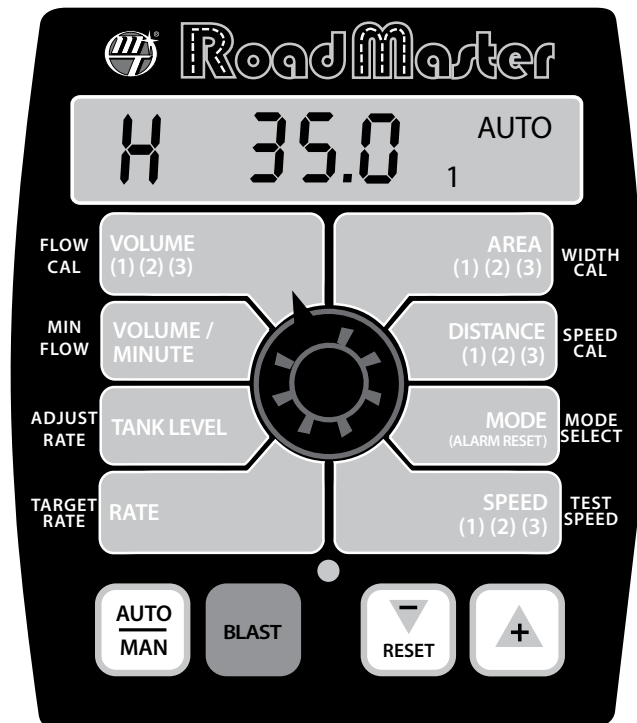

Operation (cont.)

Resetting System Counters

The VOLUME, AREA, DISTANCE & SPEED data counters maintain a running count during operation regardless of the position of the rotary switch. When any of these counters reach their maximum capacity, or when you want to start a new count, the value may be reset to zero by performing the following routine. Counter sets may be reset independently of each other.

NOTE: If the console is locked, only Data Set 1 can be cleared.

6. Turn the sections OFF or put the system in HOLD.
7. Turn the rotary switch to Volume, Area or Distance.
8. There are three independent VOLUME counters, paired with three AREA counters, paired with three DISTANCE counters and with three SPEED Values (Average and Highest velocity). The active set of counters is indicated by the small numbers in the lower right area of the display (1, 2, or 3) when the rotary switch is in the VOLUME, AREA or DISTANCE position. Select the set of counters you want to RESET by pressing the "+" button. The small number will increment each time the "+" button is pressed (from 1 to 3, then rolls back to 1). DO NOT attempt to select the counter number by using the "-" button, because that will clear the active set of counters if held for 2 seconds. If the "-" button is accidentally pressed, the console will display "CLEAR" to alert the user that the counters will be cleared. If the user continues to hold the "-" button for 2 seconds "CLEAR" will disappear and be replaced by 0.0, indicating that the selected set of counters has been cleared.

Display indicates that counter set #1 is selected

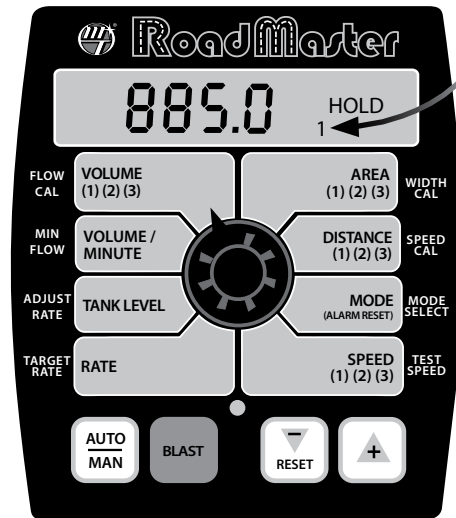

Display indicates that counter set #2 is selected

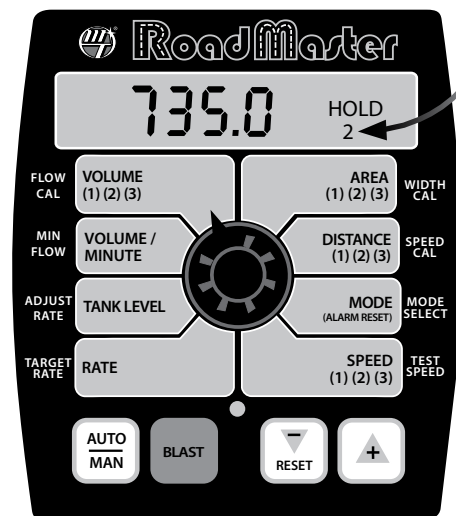

Display indicates that counter set #3 is selected

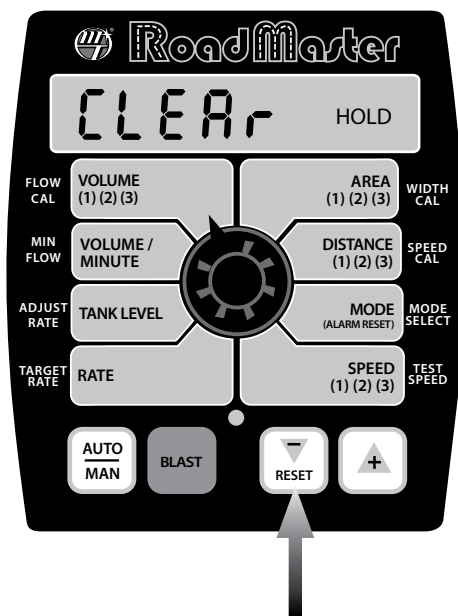
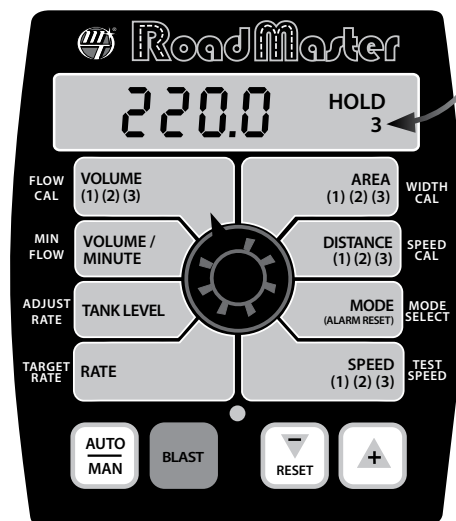

Operation (cont.)

Pre-Application System Checkout

Before beginning actual application, perform the following "Pre-field" procedure to ensure that your valve settings, nozzle selection and desired speed range will allow the ROADMASTER™ to provide the required application control. By performing all of the steps listed below, you set up your system to allow the ROADMASTER™ to perform at optimum level. Fill your application tank with clean water. **DO NOT** use chemicals until the entire system is completely checked out and operating properly.

NOTE: Pre-field System Checkout is a procedure performed while the console is in the CAL mode. During the procedure and "CAL" on the display will be flashing.

1. Start vehicle and bring the engine up to normal operating RPM.
2. Enter MAXIMUM application TEST SPEED into console. With console in HOLD, enter calibration mode. Push and hold (BLAST) button. CAL will appear on display and red light will be on if unlocked. Turn rotary switch to TEST SPEED position. Use "+" or "-" button to enter maximum application speed. Do not exit calibration mode. CAL will flash indicating TEST SPEED mode.
3. Select manual "MAN" control mode, turn all active section switches to ON position and put Run/Hold switch in RUN position. NOTE: even if no section valves are being used, the primary section should have the proper width entered, and it is used to turn the system on.
4. Turn Rotary switch to RATE position and hold "+" button to increase the RATE to maximum. The display should now read more than the maximum desired Application Rate.

Illustration 10

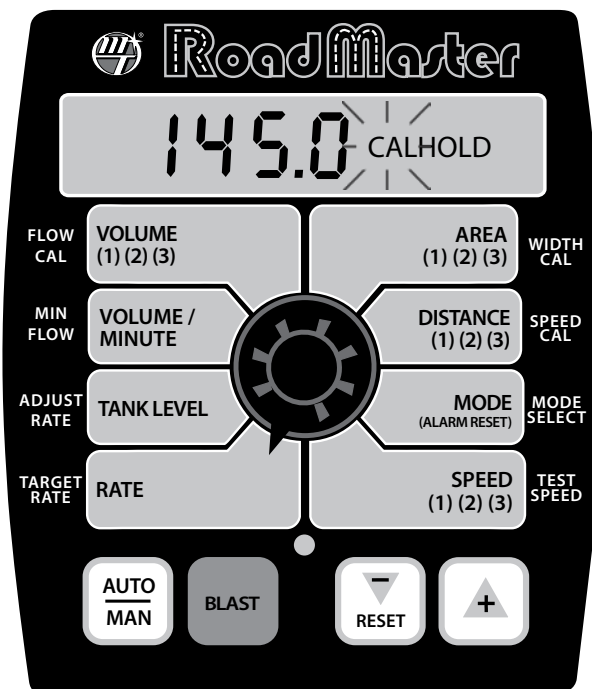

CAN'T GET THERE?

If you can't get to the desired application rate, you may need a different pump, or modifications to your plumbing configuration. **Please refer to Troubleshooting Plumbing.** Now is a good time to confirm that RATE, VOLUME/MINUTE, MPH, WIDTH and PSI all coincide with the nozzle manufacturer's charts. PSI may be slightly higher than indicated by the charts due to pressure drop across the section valves, nozzle diaphragm check valves, nozzle screens, etc.

Enter MINIMUM application TEST SPEED into console. Turn rotary switch to TEST SPEED position. Use the "+" or "-" button to enter minimum application speed. Do not exit calibration mode. (Remember, the minimum application speed is not normally less than half of the maximum application speed.)

Put Run/Hold switch in RUN position (make certain system is in Manual mode), turn rotary switch to RATE position and hold "-" button to reduce the rate to minimum. The display should now read less than the minimum desired application rate.

CAN'T GET THERE?

If holding the "-" button does not get the application rate to go below the minimum desired application rate, **please refer to Troubleshooting Plumbing.**

Care and Maintenance of your ROADMASTER™ Console

Store the console in a cool, dry location if it will not be used for an extended period of time, such as during the off-season.

As with any electronic equipment, use care in cleaning so that water or other liquids do not enter the case.

Thoroughly flush flowmeter with clean water, install plastic shipping plugs and keep from freezing.

Precautions:















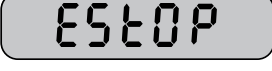



Do not expose the flowmeter to liquid temperatures exceeding 130 degrees F (55 degrees C).

Some chemicals may damage the noryl turbine or the body of the flowmeter.

If you are in doubt, contact the chemical manufacturer.

Troubleshooting

Messages/Warnings

	Average Speed (for selected Data Set) is being displayed for 2 seconds.
	Indicates memory fault. Cycling power will not clear the bad CAL message, it can only be cleared by entering Calibration or "Special Calibration" modes, checking and/or changing settings and exiting to save settings.
	BLAST is active (Blast key was pressed).
	The message alerts the user that the currently selected counter will be cleared if the reset button is held for 2 seconds. Also serves as a reminder to use "+" button to select counters.
	Emergency Stop caused by missing Flow Signal. Appears after "No Flow" error. Check flowmeter. Verify there is liquid flow and the tank is not empty.
	Trying to select Metric Units in Turf Mode or Turf Mode in Metric Units.
	Rotary switch in any position, FILL will flash if tank level is equal to or less than Tank Set Point or Float Switch detects empty Tank. Fill TANK. If using TANK counter and Tank Alarm Set Point reset TANK counter by setting the rotary switch at the TANK position and pressing the "+" button for one second. Check to make sure TANK ALARM SET POINT is properly calibrated.
	Highest Speed (for selected Data Set) is being displayed for 2 seconds.
	In Lane Mode when a Boom is selected for Width Cal a letter will display for 1 second that identifies the selected Boom. After 1 second the displayed BOOM letters clear and the Boom Width is displayed.
	Low Power. Check all power and ground connections.
	Will flash in display if rotary switch is in Width position, system is in Cal mode and no booms are turned on. Make sure system is in run and a boom switch is turned on, also check Run/Hold switch or sensor and connections.
	Will flash in display if rotary switch is in RATE position and should have flow (In Run, some booms on, speed greater than 0) but no flow is detected. Check flowmeter and flow harness connections per Troubleshooting section.
	Will flash in display if rotary switch is in RATE position and there is no Speed signal regardless of all other conditions. Check speed sensor and connections per Troubleshooting section.
	Counters (DISTANCE or AREA or VOLUME) have reached their maximum. RESET (see page 25) to clear counters and resume counting.
	"Special" Calibration mode is active. Appears when entering Special Calibration mode (hold AUTO/MAN and CAL buttons while turning console on).
	An unused SPECIAL CALIBRATE or LIVE CALIBRATE position.
	Warn LED flashes when the Rate error is over 10% or Volume/Minute is below the Minimum, or Tank is less than Tank Set Point. It is on steady when in CAL mode or SPECIAL CAL mode or Test Speed if console is unlocked.
	Alarm will sound if Alarm Enable is ON and either the Tank Level is below minimum or the Optional Tank Level Switch is active, or if Application Rate error rate is greater than 10% and the console is in Auto with adequate ground speed.

Audible Alarm

Troubleshooting (cont.)

General

All ROADMASTER™ consoles, flowmeters and harnesses are tested prior to packaging, so unless there has been damage in shipment you can be confident that everything will be operational when you receive it.

However, if you do encounter a problem that appears to be related to equipment failure, **DO NOT OPEN THE CONSOLE**. Your system is protected by a warranty, and Micro-Trak Systems, Inc. will gladly correct any defect.

Many problems are the result of mistakes in installation or operation. Before returning any parts for service, carefully check your installation and review the operating instructions. *For easy-to-follow guidelines, refer to the Troubleshooting Section which follows.*

CONSOLE APPEARS DEAD

- Using your test light, check for 12 volts at the power source. Trace cable toward battery looking for breaks. Also check any fuses or circuit breakers that supply power to the console. Then check for damaged power cable or reversed terminals. (*Console requires 12 volts for proper operation*).

SPEED IS ALWAYS ZERO OR ERRATIC

- Check for properly calibrated SPEED CAL number.
- Review speed sensor installation. If using a Magnetic Speed Sensor, check for proper mounting, alignment and spacing of speed sensor in relationship to magnet assembly. Make sure magnet polarities are alternated. Also check cable for breaks or incomplete connection.

NOTE: For more suggestions on solutions to speed problems, see console input section and Troubleshooting SPEED Sensor section on next page.

AREA COUNT IS INACCURATE

- Implement width or Speed Calibration was measured incorrectly or programmed incorrectly. Go back through the original procedures, make changes, and test for area count again. Verify accuracy with formula:

Turf = Distance x Width in feet/1000

Yard² = Distance x Width in yards

Acres = Distance x Width in feet/43560

Hectares = Distance x Width in meters/10,000

Meters² = Distance x Width in meters

DISTANCE COUNT IS INACCURATE

- Speed Calibration was incorrectly measured or entered. Review calibration, readjust and test. *See Appendix C.*

NO READOUT OF GALLONS (LITERS), OR GALLONS (LITERS) PER MINUTE

- Check to see that the pump and equipment are operating properly. If liquid is moving through the line, check the flow sensor to be sure it is screwed all the way into the flowmeter.
- Check to see that a FLOW CAL number has been entered. Also check cable for breaks or incomplete connection. (See Console Input Section). If the flowmeter is new or has not been used for a long period of time, the turbine may be sticky. Flushing the system out with water should make the turbine spin freely.
- Flow rate may be too low to register a reading, or foreign material may be lodged in the flowmeter. Shaking the Flowmeter end to end should produce a "rattling" sound (shaft end play). Blowing in the meter from either end should spin the turbine freely. See Flowmeter Assembly; Appendix E, for details.

TOTAL LIQUID USED IS INACCURATE

- This may result from an incorrectly-entered "FLOW CAL" value. Check the number stamped on the flowmeter tag, and be sure this is entered in the console's "FLOW CAL" position. If the meter has been used for some time, wear may have changed the Flow Cal value.
- Check the mounting position of the flowmeter. With lower flow rates, the meter should be mounted vertically with flow going up.
- Another cause may be inaccurate sprayer tank markings.

ELECTRICAL INTERFERENCE

- Erratic operation of the system may be the result of electrical interference from ignition wires or inductive loads (electrical clutch, fan, solenoid, etc.).
- Always try to route wires as far away from suspect areas as possible. If problems occur, you may need to relocate the console and/or wiring harness, or install a noise suppressor and/or spark plugs.

DISPLAYED MEASUREMENTS DO NOT MAKE SENSE

- The console may be in the incorrect measurement units (English or Metric) or Application mode.

NOTE: Changing UNITS will load defaults, so they should always be changed first and then all other CALIBRATE and SPECIAL CALIBRATE values may be set.

- MODE SELECT in CALIBRATE allows the user to change the MODE. Pressing the "+" or "-" (Reset) will toggle between Lane, Ag, Dust and Turf (except in Metric) MODE and the display will show LAnE, Ag, dUSt and turF.

DISPLAY READS "99999"

- DISTANCE, TOTAL AREA, and TOTAL FLOW will read 99999 when they have reached their maximum count. Reset to zero to reset counter.

Troubleshooting (cont)

Checking Individual Components

CONSOLE INPUTS

If there is no response from any of the following tests, refer to the main wiring diagram to locate the next connector in line toward the console and repeat the test at that connector. If there is a response at that connector, the problem may be in the cable between the two connectors (or the connectors themselves).

SPEED INPUT

Turn rotary switch to SPEED position and disconnect the speed sensor (yellow tie) from the main harness. Check for 12 volts between pins B (red) and C (yellow) of the main harness speed cable (yellow tie). Using a clip lead or other jumper wire (such as a paper clip bent in a "U"), several times rapidly short together pins A (orange) and C (yellow) of the 3-pin connector (See Illustration 11). The console should respond with some speed reading.

FLOW INPUT

Turn rotary switch to VOLUME/MINUTE (not RATE) and disconnect the flow sensor (green tie) from the main harness. Check for 12 volts between pins A (violet) and B (gray) of the main harness flow cable (green tie). Using a clip lead or other jumper wire (paper clip bent in a "U"), several times rapidly short together pins B (gray) and C (blue) of the 3-pin connector (See Illustration 11). The console should respond with some Volume/Minute reading.

TANK SWITCH INPUT

First Verify that ALARM ENABLE is ON. (See "Special Calibration page 21). With ALARM ENABLE turned ON, if the Tank Switch is opened, the Audible Alarm should turn on after a 15 second delay. If the switch is closed, the alarm will turn off. Verify by disconnecting the switch and shorting pins A and C on the cable connector.

RUN/HOLD INPUT

If using P/N 14361 (Run/Hold Switch Kit) or other switch, disconnect the cable from the switch and the HOLD Icon will NOT be displayed. Short between pins A and C and the HOLD Icon should turn on; if not, the console input is bad, otherwise either the switch or extension cable is bad. If using a Hall-Effect magnet Run/Hold sensor, first check for 12V between B and C, then proceed per above.

Illustration 11

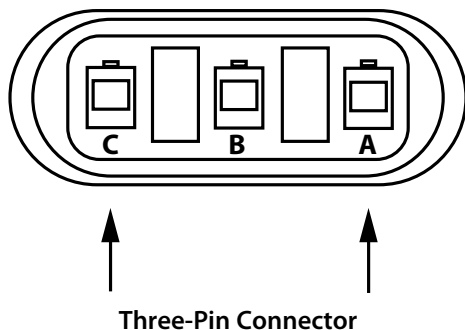

HARNESS

The harness can be checked using an ohmmeter or continuity tester. The main wiring diagram shows the pin-out of all connectors. See page 8 for wiring diagram.

MAGNETIC HALL-EFFECT SPEED AND FLOW SENSORS

Caution: Improper connection or voltage could damage the Hall-effect sensor. This particular type of Hall-effect sensor requires alternating magnetic polarities in order to switch. This means that the north pole of a magnet will "open" the Hall effect and the south pole of a magnet will "close" the Hall effect.

SPEED SENSOR

Ground pin C (black) and connect clean 12 volts to pin B (white) of the Hall-effect sensor cable. Connect the positive lead (red) of an ohmmeter or continuity tester to pin A (red) and the negative lead (black) of the ohmmeter or continuity tester to pin C of the Hall-effect sensor cable.

FLOW SENSOR

- Ground pin B and connect clean 12 volts to pin A of the flow sensor cable. Connect the positive lead (red) of an ohmmeter or continuity tester to pin C (red) and the negative lead (black) of the ohmmeter or continuity tester to pin B of the flow sensor cable.
- Holding the tip of the sensor up to the north pole of a magnet should result in a very high resistance (infinite), while holding the tip of the sensor up to the south pole of a magnet should result in a very low resistance (near zero).

ASTRO II AND ASTRO 5 GPS

Carefully check your installation and operating instructions. The following are tips for troubleshooting:

1. Check that 12 VDC power is available to the sensor. The LED closest to the connector cable indicates power on. (The other LED indicates GPS signal acquired)
2. Test the console inputs as described on this page.
3. Check to make sure that the GPS module is securely mounted.
4. Check for any damage to the 10 foot receiver cable.
5. If system still does not function, the Astro may be defective.

VANSCO RADAR SPEED SENSOR

Carefully check your installation and operating instructions. The following are tips for troubleshooting:

1. Check that 12 VDC power is available to the sensor.
2. Test the console inputs as described on this page.
3. If system passes all above tests, the radar may be defective.

ELECTRIC SECTION VALVES

If 12 volts and signal are present, but valves will not actuate, consult valve manufacturer's troubleshooting instructions.

Plumbing Guidelines

GENERAL

In order for your sprayer to function properly, it must be correctly plumbed.

Avoid pressure drops wherever possible. All hoses, valves and fittings (especially elbows) can cause undesirable pressure losses.

Follow these guidelines:

- Keep hoses as large as practical
- Don't use longer hoses than necessary
- Avoid bends when possible
- Use as few fittings as possible
- Use full port valves or the next larger size valve
- Long hoses should be supported to avoid sagging and kinking

Many spray tip manufacturers have charts showing pressure drops for various fittings and hose sizes.

Make certain that you have selected and installed the correct spray tips for the application, speed, and spray rate that you intend to maintain.

Don't forget the basics; leaky fittings and hoses, pinched hoses, and plugged or worn nozzles can affect performance.

PUMP INLET

The hose connecting the tank to the pump should be at least as large as the pump inlet port. The valve in this line is for complete tank shut-off only and should always be fully open during operation. If this hose is too small or the valve is partially closed, the system may not be able to reach the intended application rate and pump damage could occur.

FLOWMETER

The line feeding the flowmeter and the section shut-off valves should be at least as large as the flowmeter. The size of lines going from the shut-off valves to each section depends on the flow rate of each section.

PUMP

The pump must have enough capacity to achieve desired application rate. To determine if your pump is large enough, you must add up the volume per minute of all active sections.

Appendices

Appendix A

Optional Speed Sensor Mounting Installation

Magnets

Please read the following information about magnet spacing and polarity.

The number of magnets that must be used depends on the size of your tire and where you mount the sensor. On wheels the general rule of thumb is one magnet for each wheel bolt (minimum of two, and always an even number). For drive shafts, two magnets are usually adequate.

Some installations may require that more than two magnets be installed. To determine the number of magnets required, measure the distance traveled of one revolution of the sensor equipped wheel in inches (centimeters).

See the following tables to find the minimum number of magnets required (always an even number) - The magnets provided by Micro-Trak are marked with a punched dashed line on the SOUTH pole side of the magnet. *See Illustration 12A.*

Always use an even number of magnets, and always alternate the polarities of the magnets as you go around the wheel hub or drive shaft.

To install, mount the first magnet with the SOUTH pole side (dashed line) facing toward the hub or shaft. Mount the second magnet with the NORTH pole side facing toward the hub or shaft. *See Illustration 12B.*

For proper operation, the magnets must be evenly spaced around the wheel or drive shaft. The magnets must be at least 1" apart. *See Illustration 12C.*

NOTE: Magnets may be attached mechanically or adhered with epoxy or other high quality adhesive. When using adhesive, thoroughly clean the area of dirt and oil.

English or Turf (inches)

Wheel Circumference	40	80	120	160	200
Number of Magnets	2	4	6	8	10

Metric (cm)

Wheel Circumference	100	200	300	400	500
Number of Magnets	2	4	6	8	10

Locations where the magnetic sensor may be installed:

1. Non-driven wheel on the vehicle. This is less susceptible to errors resulting from wheel slip.
2. Vehicle drive shaft. This type of mounting is recommended for trucks, four-wheel drive tractors or other equipment that has poor or no access to a non-driven wheel. See Appendix B for magnetic speed sensor installation details for various types of wheels or drive shaft.

Locate the following parts:

- Speed sensor cable (Green body)
- Mounting "L" bracket
- Magnets
- Cable ties

Illustration 12A

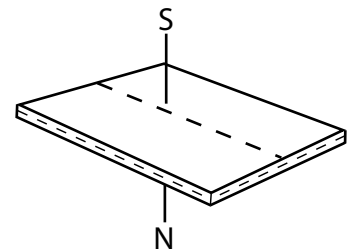
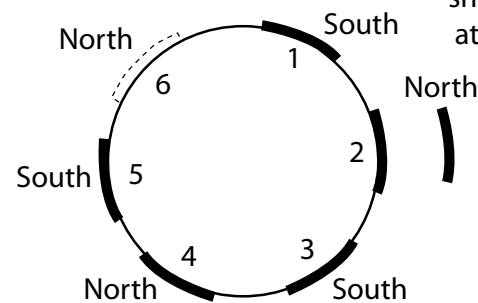
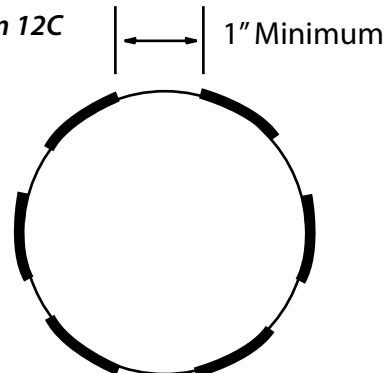

Illustration 12B



Test magnet should alternately attract and repel.

Illustration 12C



Appendix A (cont.)

Attaching the Speed Sensor

The magnets are attached to a wheel hub or drive shaft and the speed sensor is mounted directly over the magnet. When the wheel or drive shaft begins turning, a speed impulse is sent to the ROADMASTER™ console every time a magnet passes by the tip of the speed sensor. For the speed sensor to operate properly, the spacing between the magnets and the tip of the sensor must always remain constant. Before permanently mounting any parts, be sure that the location you have selected will meet the requirements shown in *Illustration 13*.

NOTE: Observe magnet polarities (see previous section).

Illustration 13

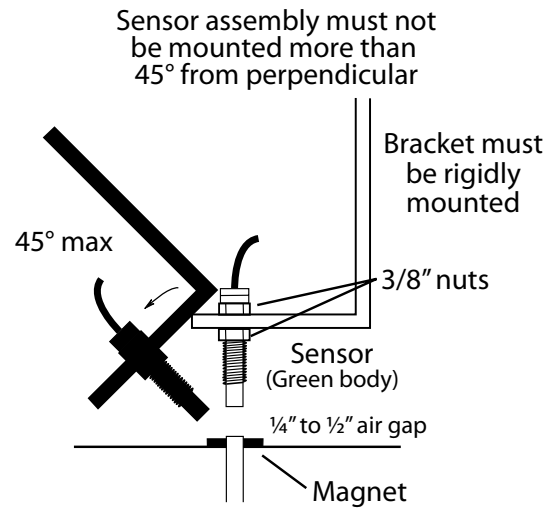

Connecting the Speed Sensor Cable

The speed sensor cable has a GREEN sensor body and mates with the 3-pin connector which is marked with a yellow cable tie. The speed sensor and the flow sensor must be connected to the proper harness connector. The speed sensor always connects to the 3-pin M/P connector with the YELLOW tie and flow sensor always connects to the 3-pin M/P connector with the GREEN tie.

See the ROADMASTER™ Wiring Diagram on page 8.

The optional Run/Hold sensor, also uses the same type of connector as the speed and flow sensors. However, the Run/Hold sensor has a GRAY tie near the 3-pin connector, the sensor body is BLACK, and it always connects to the main harness lead with the GRAY tie.

See the ROADMASTER™ Wiring Diagram on page 8.

SENSOR IDENTIFICATION CHART

SENSOR	SENSOR BODY COLOR	MAIN HARNESS TIE COLOR
Speed	Green	Yellow
Flow	Green	Green
Run/Hold	Black	Gray

Appendix A (cont.)

Optional Speed Sensor Mounting on Drive Shaft

NOTE: This is an optional method generally used on pickups or custom vehicles. It may also be necessary on any other vehicles where access to the wheels is limited. This installation requires a special calibration procedure, see page 16.

Determine the best location for the magnets on drive shaft according to which is the most practical spot to attach sensor mounting bracket. This position should be no more than 12" (.30 meters) behind the front U-joint. For best results, mount "L" bracket to transmission and mount magnets on drive shaft as close to transmission as possible. This will ensure proper alignment if drive train shifts under heavy loading.

Two magnets are required for proper Hall-effect speed sensor operation. Position them exactly opposite each other (180 degrees apart). The polarity (north and south poles) detected by the Hall-effect speed sensor must alternate as the shaft is turned. The magnets provided by Micro-Trak are marked with a punched dashed line on the SOUTH pole side

of the magnet.

- Attach magnets onto drive shaft, one NORTH pole side out and the other SOUTH (dashed) pole side out, by wrapping cable tie around shaft and magnets. Position each magnet so that its longest dimension moves in the direction of rotation. Pull cable tie tight and trim off excess. An adjustable, non-magnetic (stainless steel) band clamp may also be substituted.
- Attach sensor bracket to vehicle transmission with bolts, lock washers and nuts provided. See Illustration below. (Use self-tapping screws if bolts are not practical.) Use either the short or long end of the bracket as a base. (Allow enough room between the bracket and the magnets so that when properly spaced, the tip of the sensor will extend 1/4" [7mm] or more beyond the locking nut.)
- Turn one locking nut onto threaded sensor and insert sensor into large hole selected on mounting bracket. Turn on remaining locking nut. Set sensor to proper distance from magnets (1/4" to 1/2", or 6mm to 13mm). When distance is set, tighten nuts to lock sensor in place.
- Secure sensor cable to frame with cable ties. Place first tie as close to sensor assembly as possible.

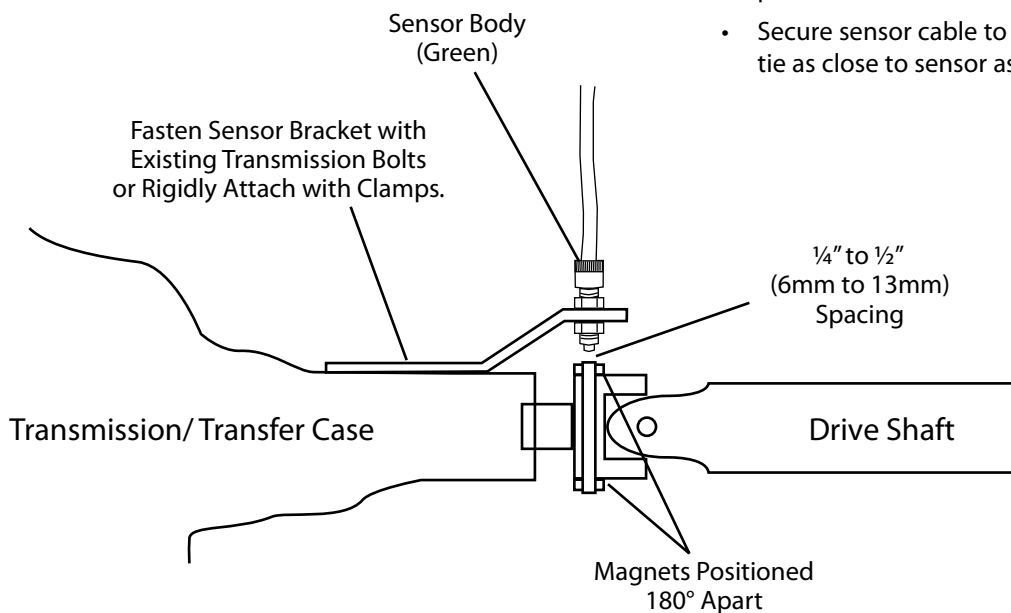

Drive Shaft Speed Sensor Calibration

Because of the difference in wheel-to-drive shaft ratios, it is difficult to determine a calibration value for installation on a drive shaft by measuring a wheel. You must start with an estimated calibration value (10-15) and then fine-tune the calibration.

Go to Appendix C for Fine-Tuning Instructions.

Appendix B

Calibrating if Using a Magnetic Speed Sensor

Determining the SPEED CAL

For the console to calculate the correct speed and measure distance accurately, the circumference of the sensor-equipped wheel must be entered. Determine the circumference of the sensor-mounted wheel to the nearest tenth of an inch (tenth of a centimeter) with the following method:

METHOD

Mark the tire with a piece of chalk and measure the distance traveled on the ground for one complete revolution. See *Illustration 14*. For improved accuracy, it is recommended that you perform this function in field conditions, measure several revolutions, and take the average.

Divide the measured revolution by the number of magnets installed to get your starting SPEED CAL calibration value. Once calibration of the system is complete, this number should be fine-tuned for optimum accuracy.

For fine-tuning the SPEED CAL value, see Appendix C on page 36.

Illustration 14

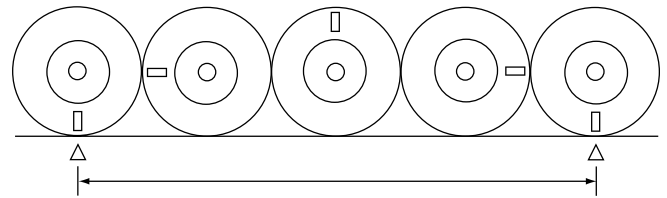

To determine SPEED CAL, measure the distance of one complete wheel revolution and divide by the number of magnets installed.

Appendix C

Fine Tuning Speed/Distance Calibration Value

This procedure is used to verify the Speed/Distance calibration. In order to achieve accurate measurements, each step in this fine tuning procedure should be performed as precisely as possible.

PREPARATION

- Once the system is fully installed and calibrated, select a straight tract of ground that is similar to your actual application conditions and as level as possible.

NOTE: Using a course with a different ground surface, such as a hard-surface road, will result in different readings than exact application conditions.

- Measure an appropriate distance for Application Mode. AG and TURF are measured in feet (meters). Dust is measured in yards (meters) and Lane is measured in miles (km). Clearly mark the beginning and end points with flags or something highly visible to the operator.

PROCEDURE

- With the console turned ON, place the Run/Hold switch in the HOLD position. The HOLD icon will be displayed. Select the Counter (1 - 3) you want to use. Be sure the display shows 0. If not, reset the distance counter by pressing and holding "RESET" until the display returns to 0 (approximately two seconds). The word CLEAR will be displayed when reset is pressed. Make sure pump is off. Turn on Section switches.
- You are now ready to drive the measured course. Pick a location on the vehicle to use as a marker for starting and stopping the distance counting function (door handle, mirror, step, etc.). You should begin driving the course well ahead of the starting flag and drive past the ending flag, using the Run/Hold switch to start and stop the counting function. It is not recommended to start from a dead stop at the starting flag and stop at the ending flag.
- Place the Run/Hold switch in RUN when the marker on the vehicle passes the starting flag to activate the distance counting function. The console display numbers will increase, adding to the distance total as you drive. Drive the pre-measured course and place the Run/Hold switch in HOLD, when the marker on the vehicle passes the ending flag, to stop the distance counting function. The console display should display "HOLD". Stop the vehicle in a level and safe area and continue with this procedure.
- With the rotary dial still at DISTANCE (SPEED CAL), press and hold the "BLAST" key for one second. Once the console is in "CAL," the speed calibration value will be displayed. Momentarily press BLAST and the word CAL will begin to flash and the distance travelled will be displayed. *See Illustration 15.*

- When the display shows distance ("CAL" is flashing), verify whether the number displayed is the exact distance you drove (within +/- 1 - 2 %). If not, press the "+" or "-" key to adjust the figure to match the distance you actually drove. If the display reads too high, use the "-" key to lower the displayed value. If the display reads too low, use the "+" key to raise the displayed value.
- When the number shown on the display matches (as closely as possible) the actual distance driven, you have arrived at the correct calibration value. If you cannot adjust the displayed distance to exactly match the actual distance driven, adjust the figure as close as possible to the actual distance. You may check the calibration number by momentarily pressing BLAST. The word CAL will stop flashing and the SPEED CAL number will appear. Exit "CAL" by pressing "BLAST" for one second.

The speed sensor is now calibrated. To verify proper calibration, repeat the procedure a second time. Write down the new speed calibration number and keep it in a safe place. If the calibration values are ever accidentally changed, you can simply re-enter this number.

Illustration 15

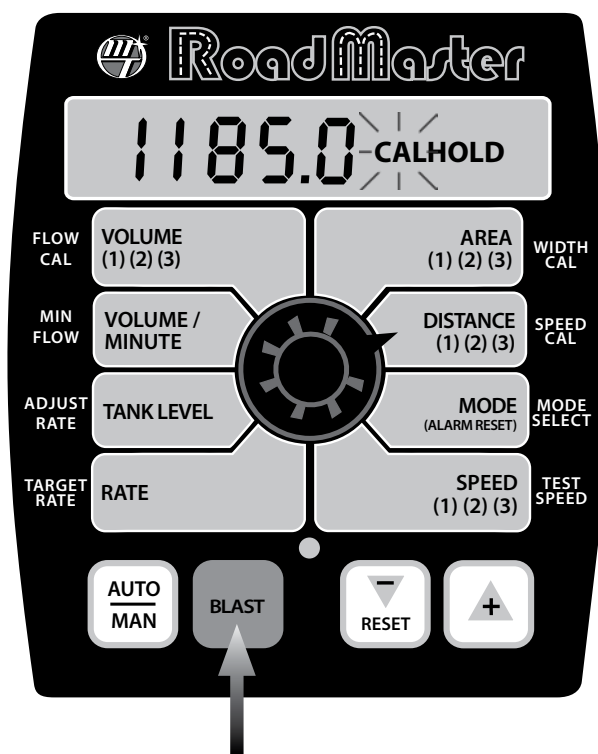

Appendix D

Fine Tuning Flowmeter Calibration Value

This procedure is used to verify and fine-tune the flowmeter calibration. Every flowmeter is calibrated with water at the factory and stamped with a calibration value. Enter that value as a starting point and use this procedure to fine-tune that value for your specific installation and spraying application. This procedure should be repeated each time a new solution is being applied (differing solutions will have a different specific gravities and different flow characteristics) or when the flowmeter installation has been altered.

This procedure is used to verify and fine-tune the flowmeter calibration. This procedure should be repeated periodically, i.e. the beginning of each season.

PROCEDURE

- Put enough water in the tank to perform this test, preferably 100 gallons or more. The larger the volume of water used, the more accurate the calibration.
- Set up a container to collect the liquid running through the system. The most accurate method to measure the volume of water run is to disconnect a main section line and run it into a large container. You can also place a container under EVERY nozzle and add together the amount from each nozzle. It is important to perform this procedure at a flow rate similar to that which will be used in the field.
- Start pump.
- Turn on at least one section.
- Put the controller in MANUAL mode. You may need to press the + or - buttons to adjust the flow of liquid through the system. Adjust the system pressure to the target pressure or adjust the flow rate to the target flow rate.
- Run enough water to purge all air from lines.
- Turn off all sections but leave pump running.
- Turn console rotary knob to the VOLUME position.
- Press and hold the RESET button until the display reads 0 (1 second).
- Turn on at least one section and run a known amount a water through the system (preferably 100 gallons or more).
- Stop the flow by putting the Run/Hold switch in the HOLD position or by turning off all sections. Compare the console's VOLUME reading with the amount of water collected.
- With the console in the VOLUME position, enter calibration mode. The display will show the current flowmeter calibration value and the CAL icon.
- Momentarily press the BLAST button, The CAL icon will begin to flash and the total volume counter will be displayed.
- Use the "+" or "-" button to adjust the value to match the actual amount of water collected.
- Momentarily press the BLAST button. The CAL icon stops flashing and a new flowmeter calibration number will be displayed. This is your "fine tuned" calibration number, keep it for future reference.
- Exit calibration by holding the BLAST button until the red warning light goes out (about one second).

* The most accurate method to measure the volume of water run is to place a container under EVERY nozzle and add together the amount from each nozzle. This assures that 100 percent of the water is collected and that all nozzles are spraying equally. It is important to perform this procedure at a flow rate similar to that which will be used in the field. It is also possible to disconnect the main line and run it to a large measuring container but a valve must be installed and properly adjusted to simulate actual field conditions.

Illustration 16

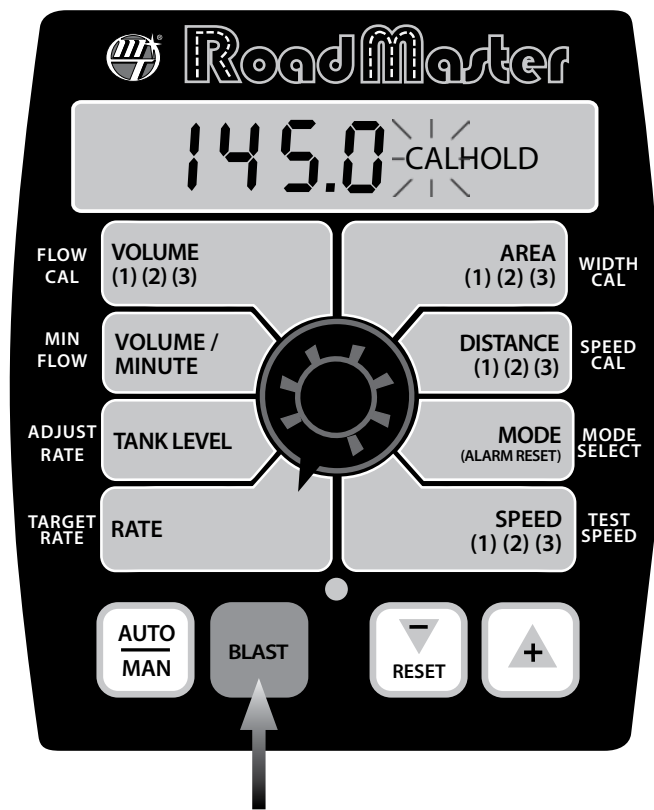

Appendix E

Flowmeter Cleaning

IMPORTANT: Opening the flowmeter will void the Flowmeter Calibration value assigned to your unit. However, you may need to take the flowmeter apart for periodic cleaning or to remove an obstruction.

If you can shake the flowmeter from end-to-end to produce a “rattling” sound (shaft-end play), or if you can blow into the meter from either end and cause the turbine to spin freely, your flowmeter does not need cleaning. If you cannot hear the “rattling” sound or get the turbine to spin freely, your flowmeter needs to be cleaned. *See Illustrations below for reassembly instructions.*

The example flowmeter shown for this procedure is a Micro-Trak FM270. These steps will also work for the Micro-Trak FM10/100 flowmeter. For information about any other model, please contact Micro-Trak directly.

DISASSEMBLING THE FM270 FLOWMETER

1. Remove the Retaining Ring on one end of the flowmeter by compressing tabs together and pulling it out.
2. Carefully remove the Bearing Housing by grasping one of the internal support fins with a needle-nose pliers and pulling. Rotating the Housing slightly while pulling may help slide it out. Avoid contacting the turbine with any tools.
3. Remove the turbine and set it aside. Do NOT remove the Spacer inside the center area of the flowmeter.
4. Repeat Steps 1-3 for the other end of the flowmeter.

CLEANING THE FM270 FLOWMETER PARTS

Use warm water and if necessary, a mild detergent and a soft bristle brush to clean all parts. Do not use solvents or diesel fuel to clean the flowmeter. A magnet works well for removing fine metallic particles from the turbine.

Inspect all parts. Check for excessive bearing or shaft wear. The shaft will wear shorter until the turbine drags on the housing. When the shaft is worn to the point of drag, the turbine must be replaced.

On a flat surface, place each Bearing Housing on end. Set and spin the turbine in each half. It should spin freely. If it does not spin freely, remove the turbine, wipe the shaft and try again. If it still does not spin freely, the shaft or bearings may have excessive wear. *(Service may be necessary).*

Rebuild kits are available from Micro-Trak.

REASSEMBLING THE FLOWMETER

Simply reverse the disassembly procedure to reassemble the flowmeter.

After assembly, shaking the flowmeter end-to-end should produce a “rattling” sound (shaft end play). Blowing into the meter from either end should cause the turbine to spin freely. If the turbine only spins from one direction, install the flowmeter so that the liquid flows in that direction (service may be required).

For maximum accuracy the flowmeter should be mounted in a vertical position. Recalibration is **required** before field operation.

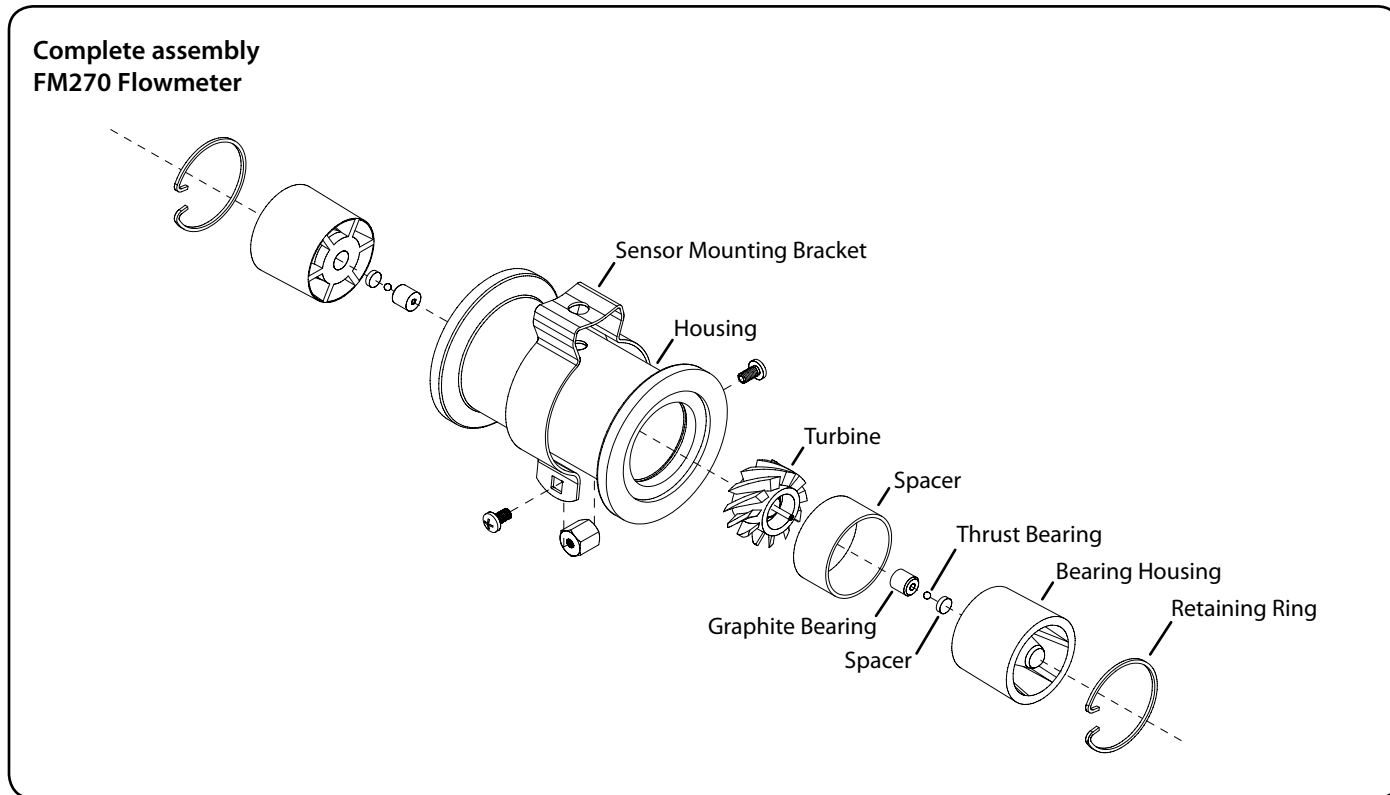

Appendix F

Radars "Y" Adapter Cables



RADAR	CONNECTOR	SIGNAL PIN
DICKEY-john	Amp	2
DICKEY-john	Cannon	3
DICKEY-john	Deutsch	3
DICKEY-john	Ford	2
DICKEY-john	Packard	B
In-Cab JD (8000 & 9000's)	Metri-Pack	A
Magnavox & Phillips	Packard	C
Raven	Conxall	3
Vansco	Amp	2

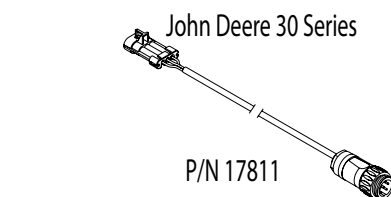
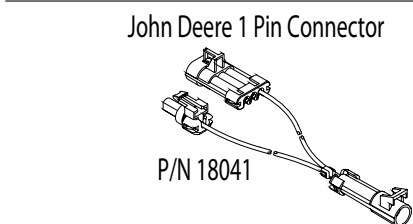
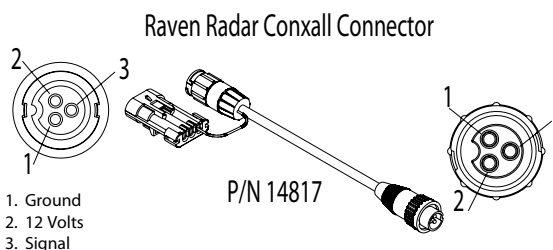
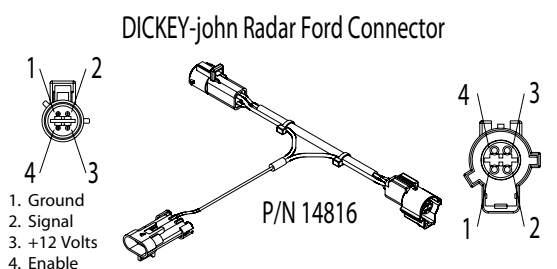
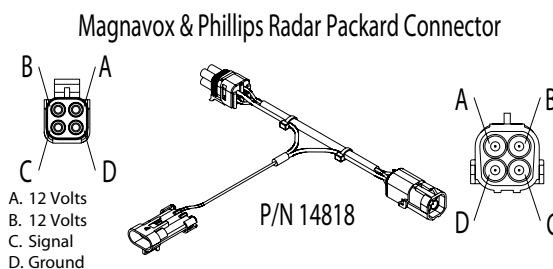
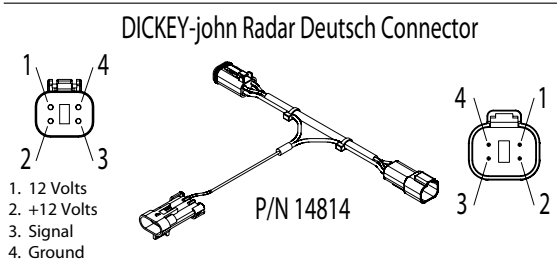
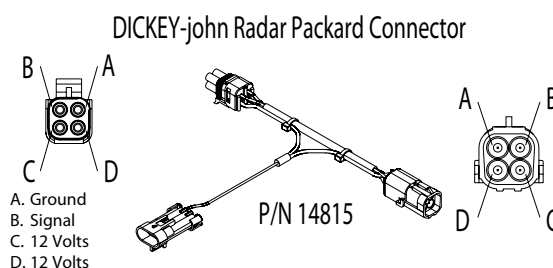
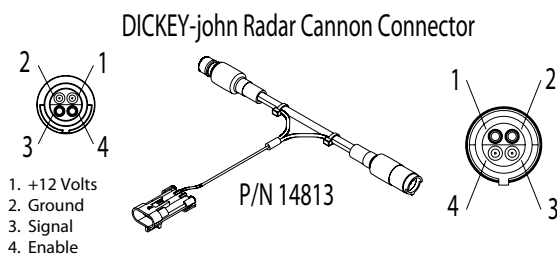
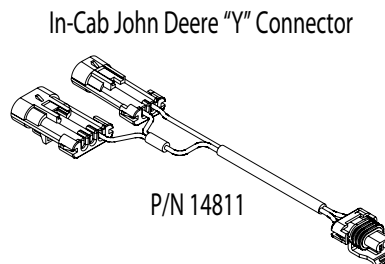
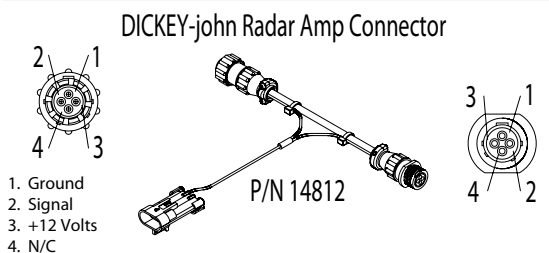

Appendix G

Conversion Chart

English to Metric		
When You Know	Multiple By	To Find
LINEAR MEASUREMENT		
inches	25.4	millimeters
feet	0.305	meters
yards	0.914	meters
miles	1.61	kilometers
LAND MEASUREMENT		
square inches	645.16	square millimeters
square feet	0.093	square meters
square yards	0.836	square meters
acres	.405	hectares
square miles	2.59	square kilometers
LIQUID MEASUREMENT		
fluid ounces	29.57	milliliters
pint	0.473	liters
quart	0.946	liters
gallons	3.785	liters
VOLUME		
cubic feet	0.028	cubic meters
cubic yards	0.765	cubic meters
DRY MEASUREMENT		
quart	1.101	liters
peck	8.810	liters
bushel	35.239	liters
FUEL CONSUMPTION		
10 miles per gallon = 4.25 kilometers per liter		

Metric to English		
When You Know	Multiple By	To Find
LINEAR MEASUREMENT		
millimeters	.039	inches
meters	3.28	feet
meters	1.09	yards
kilometers	.62	miles
LAND MEASUREMENT		
square millimeters	0.00155	square inches
square meters	10.764	square feet
square meters	1.195	square yards
hectares	2.47	acres
square kilometers	0.386	square miles
LIQUID MEASUREMENT		
milliliters	0.034	fluid ounces
liters	0.529	pint
liters	0.264	quart
liters	2.64	gallons
VOLUME		
cubic meters	35.314	cubic feet
cubic meters	1.307	cubic yards
DRY MEASUREMENT		
liters	1.101	quart
liters	8.810	peck
liters	35.239	bushels
FUEL CONSUMPTION		
10 kilometers per liter = 23.5 miles per gallon		

Conversion Abbreviations

Symbols	Symbols	Symbols
in. = inches	pt. = pint	km = kilometers
ft. = feet	qt. = quart	mm ² = square millimeters
yd. = yards	gal. = gallon	m ² = square meters
mi. = miles	ft ³ = cubic feet	ha = hectares
in ² = square inches	yd ³ = cubic yards	km ² = square kilometers
ft ² = square feet	pk. = peck	ml = milliliters
yd ² = square yards	bu. = bushel	l = liters
mi ² = square miles	mm = millimeters	dal = dekaliters (10 liters)
fl oz. = fluid ounces	m = meters	m ³ = cubic meters

Appendix H

Data List for Data Logging On-The-Go

Field No.	No. Characters	Parameter	Value	Description
0	1	Send Prefix	"D"	
1	1-5	Current Target Rate	0 to 99999	(G/Lm, I/Lkm, G/A, G/T, I/h) x 10, (G/Yd ² , I/m ²) x 1000
2	1-5	Actual Application Rate	0 to 99999	(G/Lm, I/Lkm, G/A, G/T, I/h) x 10, (G/Yd ² , I/m ²) x 1000
3	1-3	Speed	0 to 999	(mph, km/h) x 10
4	1	Pressure	0	Unused
5	1	Flow Rate	0	Unused
6	1-5	Active Section Width	0 to 65535	x 1 inch or x 1000 m
7	1	Boom Flags	Bit 0 = Boom 1	0 = Switch Off, Boom Enable Off or Width =0
			Bit 1 = Boom 2	1 = Switch On, Boom Enable On or Width > 0
			Bit 2 = Boom 3	
			Bit 3 = Boom 4	
			Bit 4 = Boom 5	
8	1	Mode Flags	Bit 0 = Console Hold	1 = Hold
			Bit 1 = Remote Hold	1 = Hold
			Bit 2 = PC Hold	1 = Hold
			Bit 3 = Auto	1 = Auto, 0 = Manual
			Bit 4	Unused
			Bit 5 = Blasting	1 = Using Blast Target, 0 = Normal
9	1	Status Flags	Bit 0 = Rate Warning	Application Error > 10%
			Bit 1 = Bad Cal	EEPROM Checksum Failed
			Bit 2 = Tank Empty Alarm	

Appendix I

Totals Data List for Downloading Accumulated Data

Field No.	No. Characters	Parameters	Value	Description
0	1	Send Prefix	t (ASCII 74 ₁₆)	T request response
1	1-3	Vehicle Number	0 to 255	Vehicle Identification Number
2	8	Date (of download)	01/01/06 to 12/31/99	Month/Date/Year
3	5	Time (of download)	00:00 to 23:59	Hour: Minute, 24 hour clock
4	1-7	Area 1	.0 to 99999.9	Lane Miles, Acres, Turfs, Lane km
			.00 to 99999.9	hectares
			0 to 9999990	Yd ² , m ²
5	2-6	Volume 1	.0 to 99999.9	Gallons or liters
6	2-6	Distance 1	.0 to 99999	Feet, Yards, Miles, meters or kilometers
7	2-4	Average Speed on Area 1	.0 to 99.9	mph or kph
8	2-4	Highest Speed on Area 1	.0 to 99.9	mph or kph
9	8	Date 1 Cleared	01/01/06 to 12/31/99	Month/Date/Year
10	5	Time 1 Cleared	00:00 to 23:59	Hour: Minute, 24 hour clock
11	1-7	Area 2	.0 to 99999.9	Lane Miles, Acres, Turfs, Lane km
			.00 to 99999.9	hectares
			0 to 9999990	Yd ² , m ²
12	2-6	Volume 2	.0 to 99999.9	Gallons or liters
13	2-6	Distance 2	.0 to 99999	Feet, Yards, Miles, meters or kilometers
14	2-4	Average Speed on Area 2	.0 to 99.9	mph or kph
15	2-4	Highest Speed on Area 2	.0 to 99.9	mph or kph
16	8	Date 2 Cleared	01/01/06 to 12/31/99	Month/Date/Year
17	5	Time 2 Cleared	00:00 to 23:59	Hour: Minute, 24 hour clock
18	1-7	Area 3	.0 to 99999.9	Lane Miles, Acres, Turfs, Lane km
			.00 to 99999.9	hectares
			0 to 9999990	Yd ² , m ²
19	2-6	Volume 3	.0 to 99999.9	Gallons or liters
20	2-6	Distance 3	.0 to 99999.9	Feet, Yards, Miles, meters or kilometers
21	2-4	Average Speed on Area 3	.0 to 99.9	mph or kph
22	2-4	Highest Speed on Area 3	.0 to 99.9	mph or kph
23	8	Date 3 Cleared	01/01/06 to 12/31/99	Month/Date/Year
24	5	Time 3 Cleared	00:00 to 23:59	Hour: Minute, 24 hour clock
25	1	Units	E (45 ₁₆) or M (4D ₁₆)	E = English, M = metric
26	1	Mode	L (4C ₁₆), A (41 ₁₆)	L = Lane, A = Agriculture
			T (54 ₁₆), D (44 ₁₆)	T = Turf, D = Dust

Where:		
T = Turf - 1000 Ft2	L = Lane	G/T = Gallons/Turf
G/LM = Gallons/Lane Mile	l/Lkm = liters/Lane kilometer	G/A = Gallons/Acre
l/h = Liters/Hectare	G/Yd2 = Gallons/Sq yard	l/m2 = Liters/Sq Meter

Appendix J

Replacement Parts List

ROADMASTER™ System Components and Optional Parts

The following replacement parts are available from:
Micro-Trak Systems, Inc. • 111 East LeRay Avenue • P. O. Box 99
Eagle Lake, MN 56024 • Toll-Free: 1-888-328-9613

SYSTEM COMPONENTS

Part Number	Description
01535	Remote RUN/HOLD Sensor Kit
13181*	ROADMASTER™ Console Mount Kit
14313	10' Flow/Control/Section Harness
14315	15' Battery Cable
14516	10' Extension Cable
14360	Power Switch/Bracket Kit
14361	Run/Hold Switch/Bracket Kit
17514	ROADMASTER™ Console, Standard
17544	ROADMASTER™ Reference Manual
17560	Optional Remote Blast/Run-Hold Switch Kit

GROUND SPEED SENSORS

Part Number	Description
01410	Astro II GPS Speed Sensor (1Hz)
01425	Astro 5 GPS Speed Sensor (5 Hz)
01437	Astro 5 w/ GPS output
01526	Vansco Radar Speed Sensor w/adaptor
01531	Magnetic Wheel Speed Sensor Kit
01533	Magnetic Drive Shaft Speed Sensor Kit

OPTIONAL TURBINE FLOWMETERS

Part Number	Description
01500	FM500 Flowmeter Kit
01501	FM750 GFN Flowmeter Kit
01504	FM750 SS Flowmeter Kit
01505	FM1000 SS Flowmeter Kit
01506	FM1500 SS Flowmeter Kit
01507	FM750 SS Flowmeter Kit w/Ceramic Bearing
01511	FM2000 P Flowmeter Kit
01513	FM3000 P Flowmeter Kit
01514	FM10/100 Flowmeter Kit
01515	FM270 Flowmeter Kit
01519	FM1500 SS LF Flowmeter Kit
01650	FM750 LF GFN Flowmeter Kit
01851	FM750 LF SS Flowmeter Kit

OPTIONAL MAGNETIC FLOWMETERS

Part Number	Description
01821	MM3, .75" FPT, .13-2.6 GPM
01822	MM5, .75" FPT, .3-5 GPM
01823	MM13, .75" FPT, .6-13 GPM
01824	MM26, 1" FPT, 1.3-26 GPM
01825	MM53, 1" FPT, 2.6-53 GPM
01826	MM106, 1.5" FPT, 5-106 GPM
01827	MM158, 2" MPT, 8-158 GPM
01749	MM238, 2" MPT, 12-238 GPM

OPTIONAL FLOW CONTROL (SERVO) VALVES

Part Number	Description
00745	.75" Servo Valve Kit (150 PSI)
00746	.75" High Pressure Servo Valve Kit (300 PSI)
01564	1" Flanged Servo Valve Kit (Butterfly)
01565	1.5" Flanged Servo Valve Kit
14928	1" Servo Valve (150 PSI)
14957	1" High Pressure Servo Valve (300 PSI)

OPTIONAL HYD. FLOW CONTROL (SERVO) VALVES

Part Number	Description
01745	PWM Valve (8 GPM)
13859	5 GPM HCV 3.5 Second Valve
14885	10 GPM HCV 3.5 Second Valve
13857	15 GPM HCV 3.5 Second Valve
13860	20 GPM HCV 3.5 Second Valve
13858	35 GPM HCV 3.5 Second Valve
14933	Bypass Dump Valve
17160	Adjustable Pressure Relief Valve

Optional 2-Pin, 3-Pin and 10-Pin Metri-Pack Extension Cables					
Part No.	M/P 2-Pin	Part No.	M/P 3-Pin	Part No.	M/P 10-Pin
13200	5-foot	13205	5-foot	14363	5-foot
13201	10-foot	13206	10-foot	14316	10-foot
13202	15-foot	13207	15-foot	14317	15-foot
13203	20-foot	13208	20-foot	14364	20-foot
13204	25-foot	13209	25-foot	14365	25-foot
		13419	50-foot	14419	50-foot

Optional 2-Pin and 3-Pin Weather-Pack Extension Cables			
Part No.	W/P 2-Pin	Part No.	W/P 3-Pin
11560	5-foot	10450	5-foot
11561	10-foot	10449	10-foot
11671	15-foot	10876	15-foot
11672	20-foot	10829	20-foot
		11462	25-foot

*13181 is available only as a kit, some console mounting parts are not available as individual components.

Parts and design specifications subject to change without notice.

MANUFACTURED IN THE U.S.A BY:



MICRO-TRAK[®]
SYSTEMS, INC.

111 E. LeRay Avenue

P. O. Box 99

Eagle Lake, MN 56024-0099

Toll-Free: 800-328-9613

Phone: 507-257-3600 • Fax: 507-257-3001

www.micro-trak.com • trakmail@microtrak.com