

**RAVEN**

*Simply improving your position.<sup>SM</sup>*

# Installation & Service Manual



**SCS Sidekick Injection System**

## ***Disclaimer***

---

While every effort has been made to ensure the accuracy of this document, Raven Industries assumes no responsibility for omissions and errors. Nor is any liability assumed for damages resulting from the use of information contained herein.

Raven Industries shall not be held responsible or liable for the effects of atmospheric conditions and sunspot activity on the performance of our products.

Raven Industries cannot guarantee the accuracy, integrity, continuity, or availability of the GPS signal from the U.S. Department of Defense/NAVSTAR GPS satellites, the OmniSTAR correction service or the WAAS correction service.

Raven Industries accepts no responsibility for the use of the signal for other than the stated purpose. Raven Industries shall not be responsible or liable for incidental or consequential damages or a loss of anticipated benefits or profits, work stoppage or loss or impairment of data arising out of the use, or inability to use, the SmarTrax or any of its components.

## Important Safety Information



### Recognize Safety Information

This is the safety-alert symbol. When you see this symbol on your machine or in this manual, be alert to the potential for personal injury. Follow recommended precautions and safe operating practices.

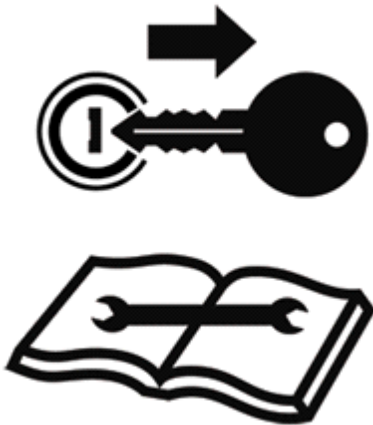

### Follow Safety Instructions

Carefully read all safety messages in this manual and on the machine's safety labels. Keep safety labels in good condition. Replace missing or damaged safety labels. Verify that new equipment components and replacement parts include the current safety labels. Replacement safety labels are available from your Raven dealer.

Learn how to operate the machine and controls. Do not let anyone operate the machine without instruction.

Keep the machine in proper working condition. Unauthorized modifications to the machine may impair the machine function and/or safety, and may shorten the life of the machine.

If you do not understand any part of this manual and need assistance, contact your local Raven dealer.



### Understand Signal Words

Signal words – DANGER, WARNING, or CAUTION – are used with the safety-alert symbol. DANGER signifies the most serious hazards.

DANGER or WARNING safety labels are located near specific hazards. General precautions are listed on the CAUTION safety labels. CAUTION also calls attention to safety messages in this manual.

## Wear Protective Clothing



Wear appropriate personal protective equipment as recommended by the chemical Manufacturer.

Wear close-fitting clothing and safety equipment appropriate for the job being performed.

Prolonged exposure to loud noise can cause impairment or loss of hearing.

Wear suitable hearing protection such as earmuffs or earplugs to protect against objectionable or uncomfortable loud noises.

Operating equipment safely requires the full attention of the operator. Do not wear music headphones while operating the machine.

## Work in a Ventilated Area



Engine exhaust fumes can cause illness or death. If it is necessary to run an engine in an enclosed area, remove the exhaust fumes from the area with an exhaust pipe extension.

If you do not have an exhaust pipe extension, open the doors to allow fresh air into the work area.

## Service Machines Safely



Tie long hair behind your head. Do not wear a necktie, scarf, loose clothing, or necklace when working near machine tools or moving parts. These items have the potential to get caught in the machine, causing severe injury or death.

Remove rings and other jewelry to prevent electrical shorts and entanglement in moving parts.

## Handle Agricultural Chemicals Safely



Chemicals used in agricultural applications such as fungicides, herbicides, insecticides, pesticides, rodenticides, and fertilizers can be harmful to your health and the environment if not used carefully.

Always follow all label directions for effective, safe, and legal use of agricultural chemicals.

To reduce the risk of exposure and injury:

- Wear appropriate personal protective equipment as recommended by the chemical manufacturer. In the absence of manufacturer's instructions, follow these general guidelines:
  - Chemicals labeled **DANGER** are the most toxic. Generally requires use of safety goggles, a respirator, gloves, and skin protection.
  - Chemicals labeled **WARNING** are less toxic than those labeled DANGER. Generally requires use of safety goggles, gloves, and skin protection.
  - Chemicals labeled **CAUTION** are the least toxic. Generally requires use of gloves and skin protection.
- Always avoid inhaling chemical spray or dust.
- Always have soap, water, and towels available when working with chemicals. If a chemical comes in contact with skin, hands, or face, wash immediately with soap and water.
- Wash hands and face after using chemicals and before eating, drinking, smoking, or using the restroom.
- Do not smoke or eat while applying chemicals.
- After handling chemicals, always bathe and change clothes. Wash clothing before wearing it again.
- Seek medical attention immediately if illness occurs during or shortly after the use of chemicals.
- Store chemicals in their original containers. Do not transfer chemicals to unmarked containers or to containers used for food or drink.
- Store chemicals in a secure, locked area away from human or livestock food.
- Keep children away from areas used to store chemicals.
- Always dispose of chemical containers properly. Triple-rinse empty containers and puncture or crush containers and dispose of them properly.



## Service and Operate Chemical Sprayers Safely



Chemicals used in agricultural sprayers can be harmful to your health and the environment if not used carefully.

Always follow all label directions for effective, safe, and legal use of agricultural chemicals.

To reduce risk of exposure and injury:

- Wear appropriate personal protective equipment as recommended by the chemical manufacturer. Refer to the *Handle Agricultural Chemicals Safely Section* for further information.
- Fill, flush, calibrate, and decontaminate the sprayer in an area where runoff will not reach ponds, lakes/streams, livestock areas, gardens, or people.
- Keep children away from chemicals, chemical solutions, and rinsing agents.
- If spray or chemical concentrate comes in contact with skin, hands, or face, wash immediately with soap and water. If spray or chemical concentrate gets into the eyes, flush immediately with water.
- If the nozzle clogs or the system malfunctions, stop the engine and relieve spray pressure from the system.
- Do not use your mouth to clear obstructions from nozzle tips or other components. Keep spare nozzle tips on hand for replacement.
- Minimize risk of spray drift:
  - Use large nozzle tips operated at lower pressures.
  - Do not operate the solution delivery system at pressures exceeding 50 psi (345kPa, 3.5 bar).
  - Do not spray when winds exceed 10 mph/16 kmph.
  - Do not spray when the wind is blowing toward a nearby sensitive crop, garden, or populated area.
- Properly dispose of unused chemicals, flushing solution and empty chemical containers.
- Decontaminate equipment used in mixing, transferring, and applying chemicals after use.





## **⚠ CAUTION**

*During application of hazardous pesticides, residue can build up on the inside or outside of the vehicle. Clean the vehicle thoroughly according to the Use instructions of hazardous pesticides.*

## **Clean the Vehicle of Hazardous Pesticides**

When exposed to hazardous pesticides, clean the interior and exterior of the vehicle daily to keep it free of visible dirt and contamination accumulation.

1. Sweep or vacuum the floor of the cab.
2. Clean headliners and inside cowlings of the cab.
3. Wash the entire exterior of the vehicle.
4. Dispose of any wash water contaminated with hazardous concentrations of active or non-active ingredients according to published regulations or directives.



## **Dispose of Waste Properly**

Improper disposal of waste can threaten the environment and ecology. Potentially harmful waste used with equipment include oil, fuel, coolant, brake fluid, filters, and batteries.

Use leak-proof containers when draining fluids. Do not use food or beverage containers, as this may cause someone to accidentally ingest the chemicals.

Do not pour waste onto the ground, down a drain, or into any water source.

Air conditioning coolants escaping into the air can cause damage to the atmosphere. Government regulations may require a certified air conditioning service center to recover and recycle used air conditioning coolants.

Inquire on the proper method to recycle or dispose of waste from your local environmental or recycling center.



## **Live With Safety**

Before returning the machine to the customer, make sure the machine is functioning properly, especially the safety systems. Install all guards and shields.

THIS PAGE INTENTIONALLY LEFT BLANK



# TABLE OF CONTENTS

SYSTEM SPECIFICATIONS .....	2
INTRODUCTION .....	3
OPERATION .....	4
SYSTEM DIAGRAM .....	5
INSTALLATION	
1. INJECTION MODULE .....	6
2. PLUMBING .....	7
3. CONSOLE .....	9
4. CABLING .....	10
BATTERY CONNECTIONS .....	11
CONSOLE FEATURES .....	12
CONSOLE PROGRAMMING .....	13
1. CALCULATING "METER CAL" .....	14
2. CALCULATING "VALVE CAL" .....	14
3. CALCULATING "SPREADER CONSTANT" .....	15
4. DETERMINING COUNTS PER REVOLUTION OF GEAR MOTOR SHAFT .....	15
5. ALTERNATE METHOD OF CALCULATING SPREADER CONSTANT .....	16
6. CONSOLE CALIBRATION .....	17
7. OTHER DISPLAY FEATURES .....	19
HIDDEN FEATURES .....	20
INITIAL INJECTION SET-UP .....	29
PREVENTIVE MAINTENANCE .....	30

---

## APPENDIXES

---

1. SIDEKICK INJECTION SYSTEM TROUBLESHOOTING FLOWCHART .....	31
2. PROCEDURE TO TEST CONSOLE ENABLE .....	32
3. PROCEDURE TO TEST CABLES .....	33
4. PROCEDURE TO TEST SPEED SENSOR EXTENSION CABLES .....	34
5. PROCEDURE TO TEST METERING SENSOR CABLES .....	35
6. PROCEDURE TO TEST TACH GENERATOR .....	36
7. PROCEDURE TO TEST METERING SENSOR .....	37
8. PROCEDURE TO RE-CALIBRATE PUMP .....	38
9. PROCEDURE TO TEST FLOW MONITOR SENSOR .....	39
10. SENSITIVITY ADJUSTMENT PROCEDURE, MANIFOLD FLOW MONITOR SENSOR .....	40
11. PROCEDURE TO TEST VACUUM SWITCH .....	41
12. ALTERNATE TANK SELECTION .....	42
13. SERIAL INTERFACE .....	43
14. SCS-SIDEKICK COMMUNICATION STRINGS .....	44

## REPLACEMENT PART SHEETS

# SYSTEM SPECIFICATIONS

## **CONSOLE:**

4 Digit Display  
Keyboard Data Entry System  
Microprocessor Based  
PWM Motor Control W/Tach  
Automatic Control

## **CABLES:**

15' Console Cable    P/N 115-0171-130  
27' Product Cable    P/N 115-0171-138  
Extension Cables Available

## **MODULE:**

Pump: Piston  
150 PSI Max

Capacity:    5-200 oz/min

# INTRODUCTION

The Raven SCS SIDEKICK INJECTION SYSTEM is designed to improve the accuracy and uniformity of spray applications. Its performance relies on the installation and preventive maintenance of the complete sprayer. It is important that this Installation and Service Manual be reviewed thoroughly before operating the system. This Manual provides a simple step-by-step procedure for installing and operating this system.

The SCS SIDEKICK INJECTION SYSTEM consists of a computer based Control Console, one Injection Module, an In-Line Mixer and cables. The Console mounts directly to a Raven Console for easy operator use. Boom inputs and speed are shared with the Raven Console.

Injection Module mounts to the framework of the sprayer. The In-Line Mixer mounts just before the Boom On/Off Valves. Appropriate cabling is furnished for field installation.

The operator sets the target application rate to be injected and the SCS SIDEKICK automatically maintains the flow regardless of vehicle speed or gear selection.

A Raven Console controls the carrier. The SCS SIDEKICK Console controls the Injection System.

Raven Consoles that may be used with the SCS SIDEKICK are listed below:

SCS 440

SCS 450

SCS 460

SCS 600

SCS 660

SCS 661

SCS 330 & SCS 400 may be used if user fabricates the mounting bracket.

# OPERATION

The SCS SIDEKICK Console must receive a “boom sense signal” from the Raven Console to which it is connected. The harness provided with the SCS SIDEKICK Console shares the On/Off Boom signal from the Raven Console to which it is connected. For this reason, both consoles BOOM CAL numbers must match.

The SCS SIDEKICK Console must also share speed with the Raven Console to which it is connected. Therefore, it is important that the initial speed selection SP1 or SP2 be the same on both consoles. Also, both Speed Cal numbers must match.

Refer to Initial System Setup.

To operate the Sidekick Injection System, place the Raven Console's Master and Boom switches to OFF. Place the Sidekick OFF/HOLD/RUN switch to RUN. The Injection Pump should not run until the Master switch and at least one Boom switch are turned on. Place Master and Boom switches to ON. The Injection Pump should now run. To stop injecting chemical and still run the carrier, place the OFF/HOLD/RUN switch to HOLD. This will flush the carrier of the chemical being injected.

# SYSTEM DIAGRAM

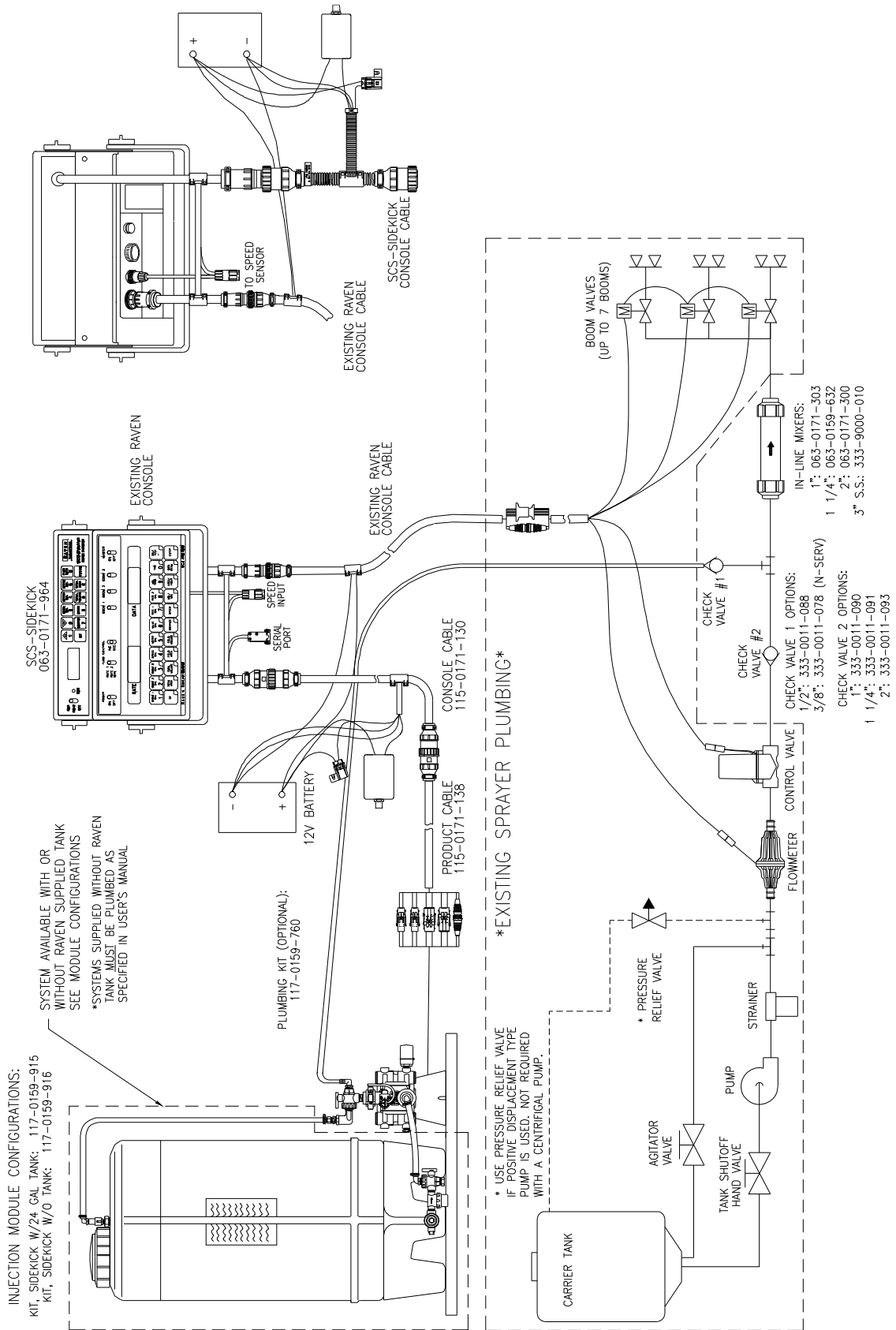

# INSTALLATION

## 1. INJECTION MODULE

- a. Select an area that is close to the Boom Valves. This will keep the amount of chemical in the line between the Injection Module and the carrier line as small as possible.
- b. Reference the platform dimensions. This is the size of the Injection Module.

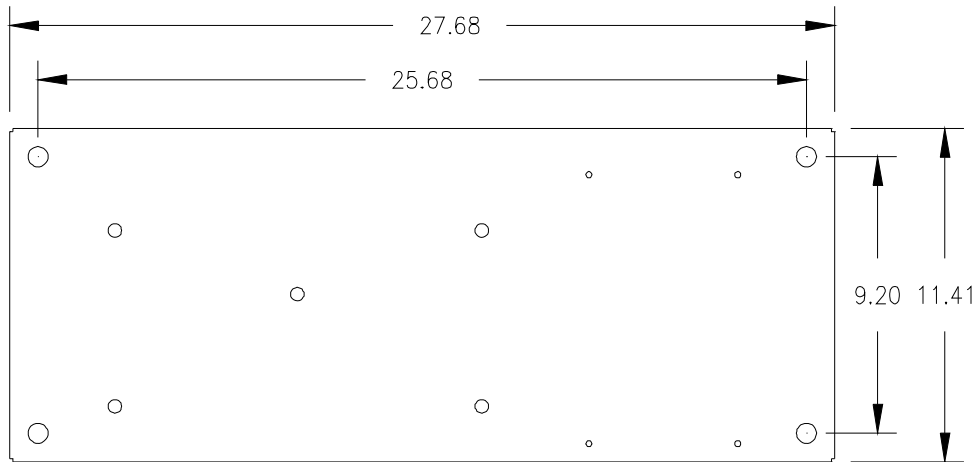

\*DIMENSIONS OF PUMP/TANK PLATFORM.  
PLATFORM USED WHEN SYSTEM ORDERED  
WITH RAVEN SUPPLIED 8, 16, 24 GALLON  
TANK CONFIGURATIONS.

- c. Take into consideration the location of the injection module's hand valves and drain. **DO NOT BLOCK THESE.**
- d. Position the Injection Module for access to the Injection Pump to perform periodic maintenance.



## 2. PLUMBING

### a. Reference Plumbing diagram

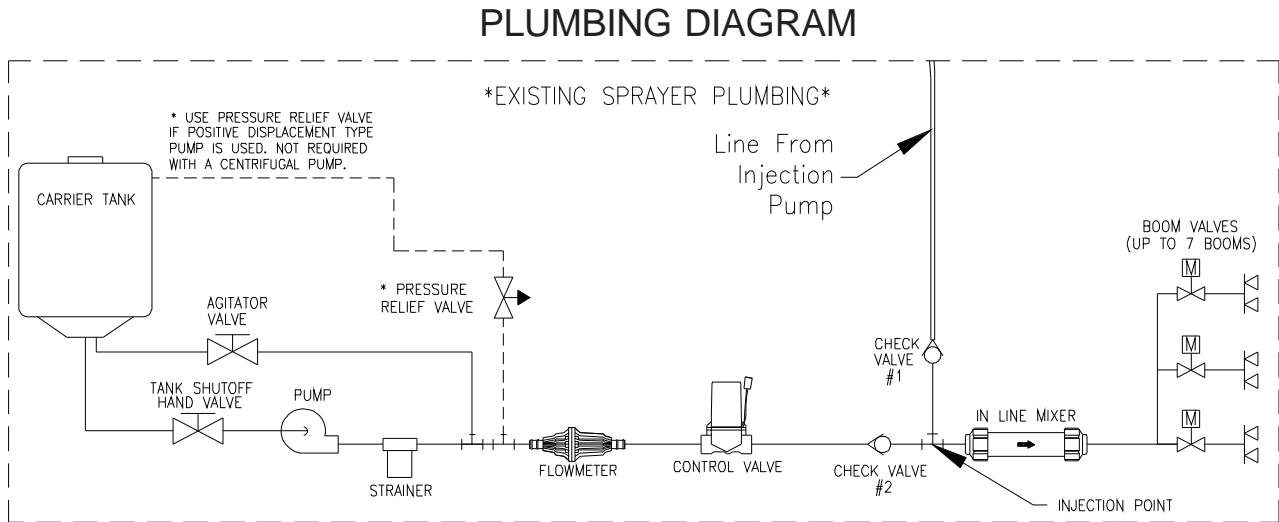

- b. It will be necessary to add the following components to the existing carrier plumbing. These components shall be plumbed as shown above.

CK Valve #1  
CK Valve #2  
In-Line Mixer

**NOTE:** Check Valves and In-Line Mixers are not included in kits. Must be ordered separately. See page 8 for selections.

- c. CK Valve #2 and the In-Line Mixer must be sized large enough to avoid excessive pressure drop. See Figure above.
- d. The Injection Point should be as close to the Boom Valves as possible.

# FIGURE 1 CHECK VALVE SELECTION CHART

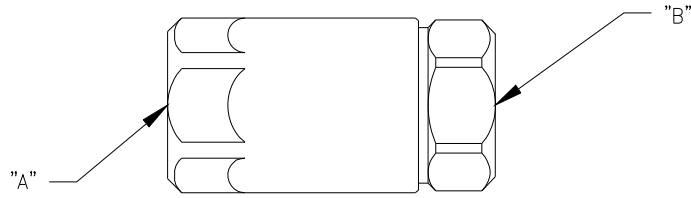

	RAVEN PART NO.	"A" NPT	"B" NPT	Cv*	
CHECK VALVE #1	333-0011-078	3/8"	3/8"	5	FOR USE WITH NH3 & N-SERVE
	333-0011-088	1/2"	1/2"	8	
CHECK VALVE #2	333-0011-090	1"	1"	14	
	333-0011-091	1 1/4"	1 1/4"	22	
	333-0011-093	2"	2"	70	
	333-0011-094	3"	3"	110	
	333-0011-095	4"	4"	175	

\* Cv = GALLONS OF WATER PER MINUTE THAT VALVE WILL PASS WITH 1 psig PRESSURE DROP.

## IN-LINE MIXER SELECTION CHART

	RAVEN PART NO.	"A" NPT	"B" NPT	Cv*	
POLY PROPYLENE	063-0171-303	1"	1"	25	FOR USE WITH NH3 & N-SERVE
	063-0159-632	1 1/4"	1 1/4"	25	
	063-0171-300	2"	2"	25	
STAINLESS STEEL	333-9000-010	3"	3"	60	
CAST IRON	063-0171-784	1"	1"	25	

### 3. CONSOLE

- a. Disconnect the cable from the existing Raven Console.
- b. Use the brackets provided to mount the SCS SIDEKICK Console to the top of the Raven Console.

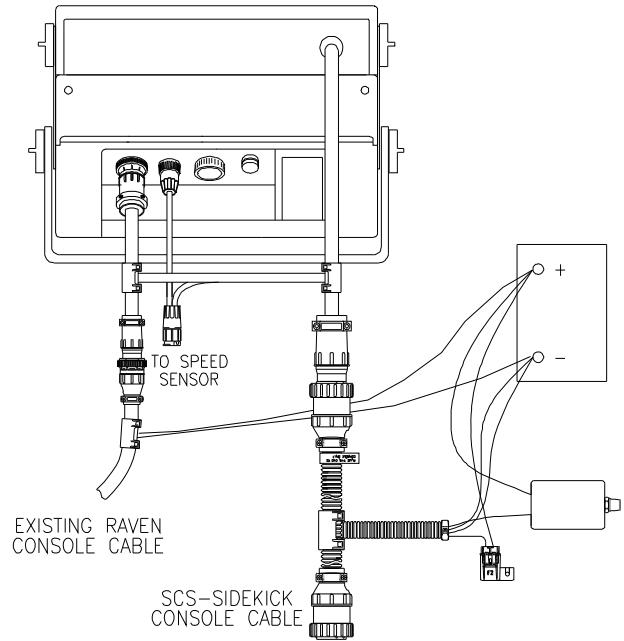
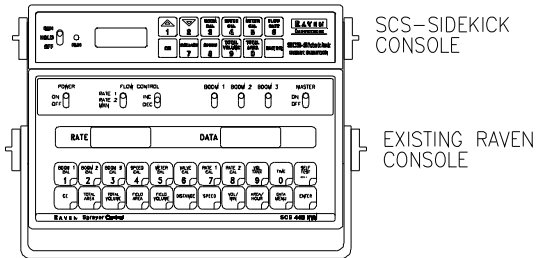

## 4. CABLING

- a. Connect both Flow Control and Speed cables from the SCS SIDEKICK Console to the Raven Console. Connect the existing Flow Control cable and Speed Sensor to the SCS SIDEKICK cable.
- b. Connect the Red and White Power Wires from the SCS SIDEKICK Console directly to the vehicle battery. **SEE BATTERY CONNECTIONS.**
- c. Route the SCS SIDEKICK cables out of the vehicle cab.
- d. Connect the 15 foot Console Control Cable to the 27' Product Cable. Use di-electric grease provided.
- e. Turn OFF/HOLD/RUN switch to OFF and route the Red and White battery wires to the 12-volt vehicle battery. Attach the White battery wire to the NEGATIVE(-) battery terminal and the Red battery wire directly to the POSITIVE (+) battery terminal. (See below) (DO NOT CONNECT RED AND WHITE WIRES TO THE STARTER). Secure the battery wires with plastic cable ties. DO NOT tie the battery wires close to the existing battery leads or any other electrical wiring. Connect the Product cable to the Injection Module. Use di-electric grease provided.

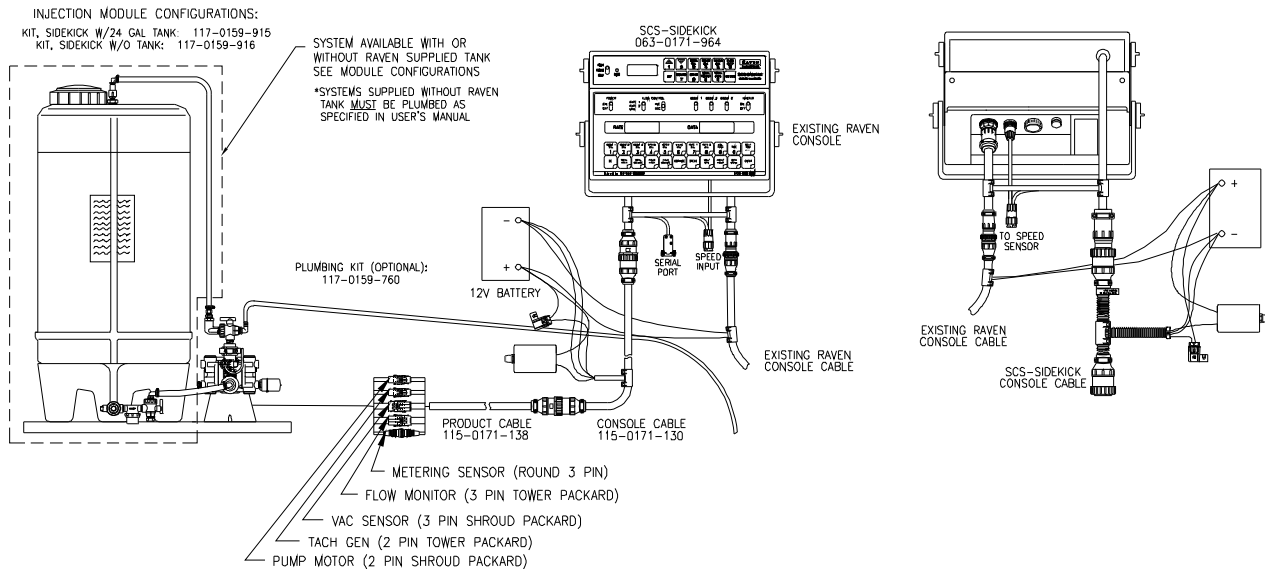

# BATTERY CONNECTIONS

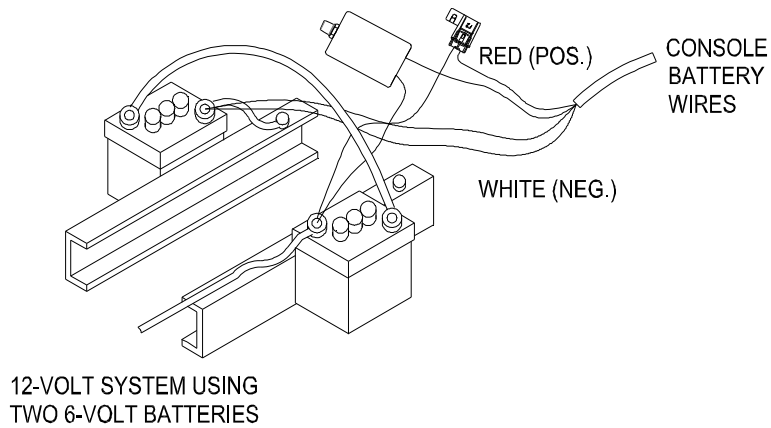
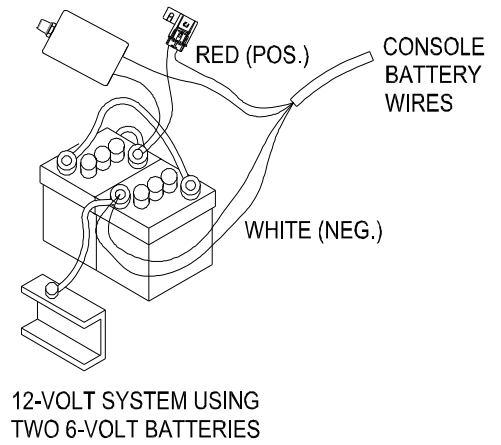
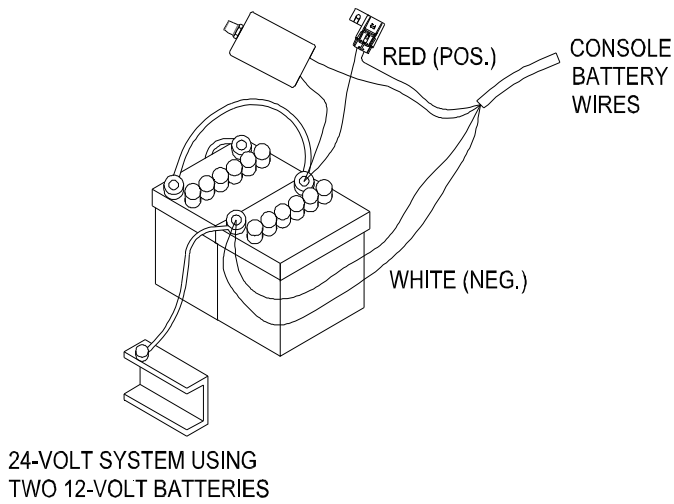
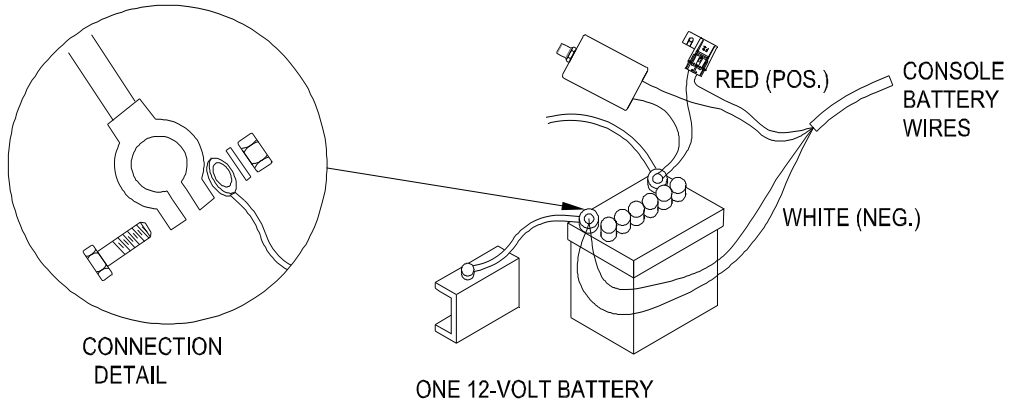

# CONSOLE FEATURES

**IMPORTANT:** This Console requires selection of **US** (acres), **SI** (hectares), or **TU** (1,000 sq. ft.) area; **SP1** (wheel drive, etc.) or **SP2** (radar) speed sensor; LI (liquid) or GR1, GR2 (Granular). (See Console Calibration) Hold TOTAL AREA key to view selections.

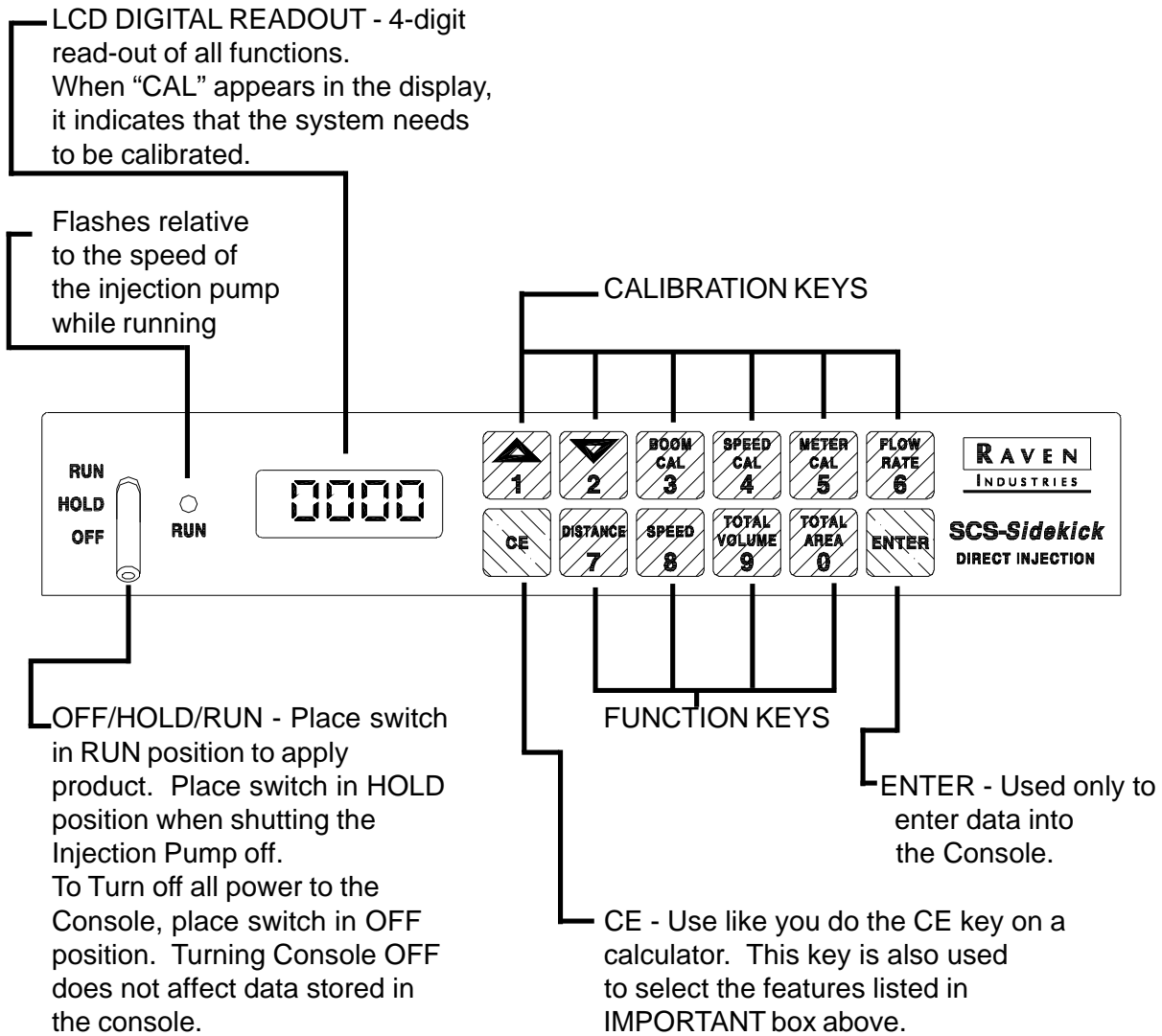

**CALIBRATION KEYS--** Used to enter data into the Console to calibrate the system.

**FUNCTION KEYS --** Used to Display Data

**BOOMCAL** -- Length of Boom in inches or [cm]. Select Boom number by using UP/DOWN arrow keys.

**SPEED CAL** -- Determined by Speed Sensor

**METER CAL** -- Meter Calibration Number

**FLOWRATE** -- Target Application Rate

**TOTALAREA** -- Total Area Applied

**TOTAL VOLUME** -- Total Volume Applied

**DISTANCE** -- Distance Traveled

**SPEED** -- Speed of Vehicle



# CONSOLE PROGRAMMING

When entering data into the Console computer, the entry sequence is always the same.

## STEP 1

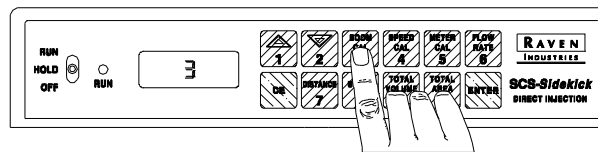

Depress the key in which you wish to enter data. The number of the key will be displayed.

## STEP 2

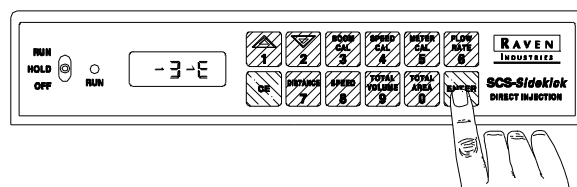

Depress the "Enter" key. 3-E will now flash in the digital display.

## STEP 3

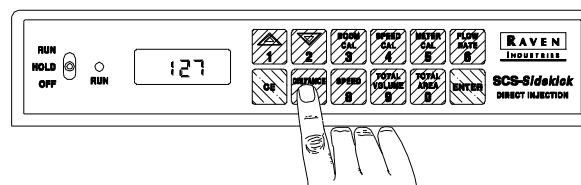

Depress the keys corresponding to the number you wish to enter (i.e. "1", "2", "7"). The numbers will flash in the digital display as they are entered.

## STEP 4

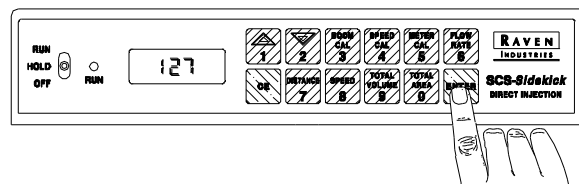

Complete the entry by again depressing the "Enter" key. Display stops flashing.



### 3. CALCULATING "SPREADER CONSTANT" (If using liquid, skip to step 6)

[only available if programmed in GR1 or GR2]

1) Find the cubic feet [Cubic cm] of discharge per 1 revolution of the Gear Motor shaft.

L = Length in inches [cm], of belt travel per 1 revolution of Gear Motor shaft

GH = Gate Height in inches [cm]

GW = Gate Width in inches [cm]

Cubic Feet [cubic cm] of Discharge per 1 revolution of Gear Motor shaft: (For GR2, calculation must include cu ft of both granular metering devices per 1 revolution of the gear motor shaft).

$$\text{cu ft/rev. of sensor} = \frac{L \times GH \times GW}{1728}$$

$$\text{cu cm/rev. of sensor} = L \times GH \times GW$$

**EXAMPLE:**

1)	L	=	<u>13</u>	inches [33 cm]
2)	GH	=	<u>7</u>	inches [18 cm]
3)	GW	=	<u>15</u>	inches [38 cm]

$$\text{cu ft/rev. of sensor} = \frac{13" \times 7" \times 15"}{1728} = .790$$

$$\text{cu cm/rev. of sensor} = 33 \times 18 \times 38 = 22,572$$

2) For RATE displayed in 1 lb increments:

$$\text{Spreader Constant (1 lb)} = \frac{\text{counts per rev of Gear Motor shaft}}{\text{cu ft/rev. of Gear Motor shaft}}$$

**EXAMPLE:** For 80 counts per rev  
Spreader Constant =  $\frac{80}{.790} = 101$

3) For RATE displayed in 1 Kg increments

$$\text{Spreader Constant (1 Kg)} = \frac{\text{counts per 1 rev of sensor} \times 100,000}{\text{cu cm / rev of Gear Motor shaft}}$$

**EXAMPLE:** 80 counts per rev =  $\frac{8,000,000}{22,572} = 797$

### 4. DETERMINING COUNTS PER REVOLUTION OF GEAR MOTOR SHAFT

Counts per 1 rev of Gear Motor shaft may be determined by entering a METER CAL number of 10, enter 0 in TOTAL VOL and turning sensor exactly 1 revolution. The number in TOTAL VOL will be the counts per 1 rev of Gear Motor shaft.

## 5. ALTERNATE METHOD OF CALCULATING SPREADER CONSTANT

For systems where calculating volume of discharge is difficult (metering wheels, augers, etc.). Spreader Constant can be determined by performing a catch test.

Confirm that Spreader Constant is zero (no decimal point in Meter Cal) and enter a Meter Cal of 200. Enter zero in Total Volume. Run machine and collect a sample large enough to weigh accurately and perform following calculation.

$$\frac{\text{Meter Cal} \times \text{Total Volume} \times \text{Product Density}}{\text{Actual Volume}} = \text{Spreader Constant}$$

<b>EXAMPLE:</b>	Meter Cal	= 200
	Total Volume	= 200
	Weight of collected material	= 128
	Product Density	= 50.0 lbs/cu. ft.

$$= \frac{200 \times 200}{128} = \frac{312 \times 50}{10} = 1560$$

Spreader Constant = 1560

Enter this number as Spreader Constant and enter Product Density as Meter Cal which will have a decimal point now.

**NOTE:** Verify Spreader Constant by performing following procedure.

- 1) Enter a "0" into the  .
- 2) With the console in the MAN mode (see Automatic/Manual control), unload a portion of the load by positioning the boom switch to ON.
- 3) Determine the actual weight of material collected.
- 4) Compare to the TOTAL VOLUME displayed by the Console.
- 5) Perform the following calculation to correct the Spreader Constant if desired:

$$\text{Corrected Spreader Constant} = \frac{\text{old Spreader Constant} \times \text{TOTAL VOLUME}}{\text{weight of material collected}}$$

<b>EXAMPLE:</b>	old Spreader Constant	=	228 [797]
	TOTAL VOLUME amount	=	2000 lbs [4400 kg]
	weight of material collected	=	1950 lbs [4290 kg]

**English (US):**



$$\text{Corrected Spreader Constant (1 lb)} = \frac{228 \times 2000}{1950} = 234$$

**Metric (SI):**

$$\text{Corrected Spreader Constant (1 kg)} = \frac{[797] \times [4400]}{[4290]} = [817]$$

This is the new Spreader Constant. Repeat this procedure until the weight of the metered material equals the TOTAL VOLUME value.

## ENTERING PRODUCT DENSITY AND SPREADER CONSTANT

- 1) Depress and hold . After 5 seconds the display will change to "vcal". Continue to hold key until "S CON" is displayed. At this time, enter the Spreader Constant. See "Calculating Spreader Constant"/
- 2) After a Spreader Constant has been entered, momentarily depress . Now enter the product density in lbs/cu ft.







## 6. CONSOLE CALIBRATION

When console power is first turned on after all installation procedures have been completed, the console will display "US" in the display window. This means the console must be calibrated or programmed before it can be operated. This is a one-time operation which does not have to be repeated. Turning OFF the power switch does not affect the console memory. All data is retained.



**IMPORTANT:** If an entry selection error is made during steps 1-6, place the OFF/HOLD/RUN switch to the OFF position. Depress the  key and hold while placing the OFF/HOLD/RUN switch to HOLD or RUN. This will "reset" the console.

**NOTE:** Boom Cal and Speed Cal must match selection and numbers programmed into existing Raven consoles.



The following steps must be followed:

- 1) Display US (acres), SI [hectares], or TU {1000 sq. ft.}.
  - a) Depressing momentarily  steps the display from US to SI.
  - b) Depressing momentarily  steps the display from SI to TU.
  - c) Depressing momentarily  steps the display from TU to US.
- 2) Selecting US, SI, or TU.
  - a) To select US, SI, or TU, step  until the desired code is displayed.
  - b) Momentarily depress . The display will now display SP1.
- 3) Display SP1 (wheel drives, etc.) or SP2 (radar).
  - a) Depressing momentarily  steps the display from SP1 to SP2.
  - b) Depressing momentarily  steps the display from SP2 to SP1.



4) Selecting SP1 or SP2.

- a) To select SP1 or SP2, step with  until desired code is displayed.
- b) Momentarily depress .

5) Displaying LI (liquid sprayer), GR1\* (single bed belt), or GR2\*\* (split bed belt).

- a) Depressing momentarily  steps the display from LI to GR1.
- b) Depressing momentarily  steps the display from GR1 to GR2.
- c) Depressing momentarily  steps the display from GR2 to LI.

6) Selecting LI, GR1, or GR2.

- a) To select LI, GR1, or GR2, step  until desired code is displayed.
- b) Momentarily depress .

\* GR1 (Single Bed) Definition of Operation  
As boom width is changed, the SCS SIDEKICK CONSOLE will change the speed of the drive motor to adjust to the desired rate.

\*\* GR2 (Split Bed) Definition of Operation  
As boom width is changed, the SCS SIDEKICK CONSOLE will not adjust the speed of the drive motor. Instead, the SCS SIDEKICK will count total volume based on the width of boom remaining on. For this reason, calibration is based on the sum of both Granular Metering devices.

7) Definition of Boom Calibration keys.

 Depressing this key displays selected boom number in DATA display. **EXAMPLE:** Boom 1 will be displayed as b-01.

 Depressing this key after selecting BOOM CAL changes the boom number. **EXAMPLE:** b-01 will change to b-02.

 Depressing this key after selecting BOOM CAL changes the boom number. **EXAMPLE:** b-02 will change to b-01.

Enter Boom Data:

- a) Select boom b-01.
- b) Use the same boom width as entered into existing Raven console.
- c) If a boom is not needed, enter a "0" for the width.

8) Enter the same SPEED CAL as entered into existing Raven console id key labelled .

9) Enter METER CAL calibration number in key labelled . When programmed in GR1 or GR2 and if spreader constant is used, enter the product density in lbs/cu.ft. as Meter Cal. NOTE: This key will not display a decimal until a spreader constant has been entered.



- 10) A VALVE CAL calibration number is automatically entered when console is programmed.

To change the VALVE CAL setting, depress key labelled  for 5 seconds. The display will show the current VALVE CAL calibration number. Enter a new VALVE CAL calibration number if desired.

- 11) Enter the FLOW RATE target application rate in oz/acre if LI is selected or lbs/acre if GR1







or GR2 is selected in key labelled .

**NOTE:** A decimal point is displayed automatically. Therefore, 20 is entered as 20.0, not 2.0.

## YOU HAVE NOW COMPLETED PROGRAMMING THE CONSOLE

The display of "CAL" will now extinguish and the console will begin to display data. If not, repeat procedure starting at step 7.

## 7) OTHER DISPLAY FEATURES

- 1) To display TOTAL AREA covered, depress key labelled . To "zero out" this total at any time, enter a "0" in this key.
- 2) To display TOTAL VOLUME sprayed, depress key labelled . To "zero out" this total at any time, enter a "0" in this key.
- 3) To display speed in MPH [km/h], depress key labelled .
- 4) To display DISTANCE in feet [m] traveled, depress key labelled . To "zero out" this total at any time, enter a "0" in this key.
- 5) To display actual application flow rate in oz/acre [dl/dl/ha], place MASTER switch in ON position and depress key labelled . To display target application flow rate, place MASTER switch to OFF and depress key labelled .
- 6) To view any of the set calibration numbers, depress the corresponding calibration keys.

# HIDDEN FEATURES

The SCS-SIDEKICK Console is equipped with many hidden features. Several Console keys have multiple features located under them. The amount of time a key is held down determines the feature that will be displayed. The display will flash the coded name of the feature that is being programmed. These features and their display codes are outlined below: (A detailed explanation of the feature follows this page.)

## Console

### Key

### Depress 5 seconds for:

### Depress 7 seconds for:

### Depress 9 seconds for:



Data Lock  
flashing "nEu.1" or "old"



(Alarm Menu)  
"A on" / "AoFF"

Display Smoothing  
"d on" / "doFF"

(Flo and VAC Alarm)  
"u on" / "uoFF"



Program Rev. Number  
"-###"

Program Part Number  
"P #"

Total Boom Width  
"b tot"



Off Target Alarm  
"or" (off Rate)

Dual Sensor Alarm  
"dF"



Control Delay  
"dLAY"



Valve Cal  
"uCAL"

Spreader Constant  
"SCon"



Flow Rate vol/min  
"FLo"

Automatic Rate +/-  
"dELt"

Low Limit Alarm  
"LL"



Automatic/Manual Control  
"C on" / "CoFF"



Self Test  
"tEst"



DATA MENU  
Ref. Data Menu Feature



Display Units  
Alternates  
"US", "SI", or "tU"  
"SP1" or "SP2"  
"L1" or "GR1" or "GR2"









## FEATURES UNDER

### 1) SEQUENCE TO ACTIVATE DATA-LOCK

- a) Depress  for 5 seconds, NEW CODE message will appear.
- b) Enter 4 digit code within 15 seconds:

**EXAMPLE:** For 1234, depress:     and .

### 2) SEQUENCE TO CHANGE DATA-LOCK

- a) Depress  for 5 seconds, OLD CODE message will appear.
- b) Enter 4 digit code within 15 seconds:     and .

NEW CODE message will appear. Enter 4 digit code within 15 seconds.

**EXAMPLE:** For 4321, depress:     and .





### 3) ENTER MODE SEQUENCE WITH ACTIVATED DATA-LOCK

- a) Depress the key into which you wish to enter data.
- b) Depress , CODE message will appear. Enter your DATA-LOCK CODE. If code is correct, "E" will appear. Now enter data normally.

\*The DATA-LOCK feature prohibits the entry of data without first entering the DATA-LOCK CODE. If DATA-LOCK is not desired, omit steps above. The DATA-LOCK CODE may be cleared by entering a code of "0" or by resetting console.

## FEATURES UNDER

### 4) ALARMMENU

- a) To display ALARM MENU, depress key labelled  for 5 seconds. "A on" will show in the display.
- 1) Momentarily depressing  toggles the display between "A on" and "A oFF". "A on" means alarm is enabled, "A oFF" means alarm is disabled.
- b) To display setting for display smoothing, press and hold key labelled  for 7 seconds. The display will show "d on" or "doFF". Selecting "d on" means the window displays target rate when actual rate is within 10% of target rate. Selecting "doFF" means the window displays actual rate. Console defaults to "d on".
- 1) Momentarily depressing  toggles the display between "d on" and "doFF".

**C) FLO AND VAC ALARM**

The SCS SIDEKICK Injection system features a Flow Monitor and a Vacuum Monitor to alert the operator in case the system malfunctions. A FLO message in the display indicates an under application of chemical. See PROCEDURE TO RE-CALIBRATE PUMP. A VAC message in the display indicates a high vacuum condition on the inlet to the injection pump. This may cause under application.

- 1) To enable or disable VAC and Flow monitor alarms, press and hold the key labelled



for 9 seconds or until "u on" or "uoFF" is displayed. "u on" = VAC and Flow alarm is ON. "uoFF" - VAC and Flow alarm is OFF.

- 2) Momentarily depressing  toggles the display between "u on" and "uoFF".

**FEATURES UNDER**



**5) DISPLAYING PROGRAM NUMBER, PROGRAM REV., TOTAL BOOM ON**

- a) To display Console Program number, depress key labelled  for 5 seconds.

- b) To display Console Program revision, depress key labelled  for 7 seconds.

- c) To display Total Length of boom detected as "on", depress key labelled  for 9 seconds. Display will alternate between "btot" (boom total) and the number in inches of detected boom length on.

NOTE: This is a trouble shooting tool used to determine if console is reading booms currently ON.

**FEATURES UNDER**



**6) OFF TARGET ALARM**

Alarm sounds when the actual rate is off from the target rate by a specified percentage. The Off Target value is preset to 30%, but may be changed to a different number.

- a) Adjusting Off Target value.

- 1) Depress  for 5 seconds. Display will show "or". Enter desired new number for OFF TARGET ALARM.

- 2) Depress  to store selection.

- b) Dual Sensor Alarm

When programmed in LI (Liquid) and controlling a Raven Sidekick Injection Pump, the console monitors the rate sensor and the flow monitor sensor. If there is an unreasonable difference between rate sensor and the flow monitor sensor, the console will sound an alarm and the console will display FLO. This means the injection pump is not metering accurately. Refer to troubleshooting guide for possible causes. The console is preset at a value of 60. Do NOT change this value. Changing this value may result in Flo alarm being on all the time or degrade performance of this feature. To access this feature, press and

hold  for 7 seconds until displays "dF". Press any key to exit.

7) **FEATURES UNDER** 

**CONTROL DELAY**

Depress key labelled  for 5 seconds. "dLAY" will be displayed.

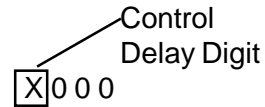



The Control Delay number is a 4 digit number. The first digit in the Control Delay number represents the time (in seconds) between when the booms are turned ON and when the Console actually begins to control the flow rate. A value of 1 - 9 means a delay of 1 - 9 seconds respectively, a value of 0 means no delay. The remaining 3 digits are always zero. The Control Delay feature only operates when the booms are toggled OFF or ON in intervals of 30 seconds or less.

8) **FEATURES UNDER** 

a) To display current VALVE CAL setting, depress key labelled  for 5 seconds. Display will change to "uCAL". Release the key to current valve cal setting. Console defaults to a valve cal number of 123.

b) To display SPREADER CONSTANT or to enter a spreader constant, console must be programmed in GR1 or GR2.

1) Depress and hold . After 5 seconds the display will change to "uCAL". Continue to hold key until "SCon" is displayed. At this time, enter the Spreader Constant. See "Calculating Spreader Constant".

2) After a Spreader Constant has been entered, momentarily depress . Now enter the product density in lbs/cu ft.

9) **FEATURES UNDER** 

**FLOW RATE VOL/MIN**

This feature allows the operator to view the flow rate in volume per minute.

a) To display volume per minute, depress and hold key labelled  for 5 seconds until the display shows "FLo". When displaying volume per minute, the display will alternate between "FLo" and the volume per min reading.

b) To exit and return to volume per area display, press key labelled  again.

**AUTOMATIC RATE +/-**

This feature sets the increment at which flow is increased or decreased in the Auto mode of

operation. Select RATE +/- for product by depressing  for 7 seconds. The display will show "dELt". Enter the desired amount for +/-.

**EXAMPLE:** If flow rate is to be changed by "1.0":  
Enter a value of 1.0 for RATE +/- . When in Auto, each time the  or

 key is depressed, the target flow rate for that product will increase or decrease by "1.0".

## LOW LIMIT FLOW SET POINT AND LOW LIMIT ALARM



- a) To display the Low Limit Flow Set Point, depress key labelled  for 9 seconds. Display will show "LL" and low limit flow rate will appear in the display. A low limit flow rate may now be entered.
- b) If the actual volume per minute falls below the set limit, the Control stops closing, an alarm sounds (if enabled) and the display flashes "-LL-".
- c) The low limit value should be determined with all booms ON. This value is automatically proportioned to the percentage of booms that are ON.

**EXAMPLE:** If the entered low limit is 4, and half the total boom length is shut OFF, the Console will automatically reduce the low limit flow set point to 2.

## 10) FEATURES UNDER

### AUTOMATIC/MANUAL CONTROL

The console defaults to Automatic Control.

- a) To place console in Manual Control, depress key labelled  for 5 seconds. "C on" will show in the display.
- 1) Momentarily depressing  toggles the display between "C on" and "CoFF". "CoFF" means control is in the manual mode.

## 11) FEATURES UNDER

### SELF TEST FEATURE

**NOTE:** When using self test for testing the system, place the Injection Modules hand valves in the recirculation position.

SELF TEST allows speed simulation for testing the system while the vehicle is not moving. Enter the simulated operating speed by depressing the key labelled  for 2 seconds. Display will show "tEst". If 6 MPH [9.6 km/h] is desired, enter 6.0 [9.6] (See CONSOLE PROGRAMMING). The SELF TEST speed will clear itself when motion of vehicle is detected by the Speed Sensor. A SPEED CAL value of 900 [230] or greater is recommended when operating this mode.

**NOTE:** To prevent nuisance clearing of self test speed, disconnect speed connector on back of the Console when Radar Speed Sensors are used.

## 12) FEATURES UNDER

The following are brief descriptions of features available under the TOTAL VOLUME key.

### DISPLAY

P r n

b E g n

### DESCRIPTION

Sends data through serial port to attached optional printer to print field begin and field end pages. (Not available when GPS or Datalog are ON)



**DISPLAY**

**DESCRIPTION**

rate	on	Turns rate change alarm ON or OFF. When rate change alarm is selected ON; alarm sounds 4 long beeps when the Rate 1 calibration number is changed via the serial port using a valid change request data string.
file	1	Used only with Raven Application Management System. See Application Management System manual for more details.
gps	1 naC	Used only with Raven Application Management System. See Application Management System manual for more details.
pref	0	Allows user to enter up to a four-digit number to represent a field. Field reference is included in field begin and field end pages and the data logger time/date string.
baud	9600	Used in GPS mode and data logging mode. Selectable between 1200 or 9600 baud.
trig	0	Used in data logging mode. The trigger determines how often actual rate data string (See Appendix 10 for Data Communication String Formats) is sent to the serial port. The trigger may be either feet [meters] or seconds.
Unit	ft	Used in data logging mode. The trigger unit is selectable between feet [meters] or seconds.
dlog	off	Turns data logger ON or OFF. (Not available when GPS is active)
time		Sets time.
month		Sets month.
day		Sets day.
year		Sets year.
pdn		Sets power down days wait.

**A) Definition of Data Menu Options:**



Depressing this key for 5 seconds displays selected Data Menu features.



Depressing these keys after selecting DATA MENU increments through desired features.



**EXAMPLE:** "Prn" "bEgn", "rAtE" "on", "FILE" "1", etc....

**B) CONSOLE DATA PRINTOUT**

a) Display will alternate between `prn` and `begn` (Print Field Begin).

1) To Print Field Begin, depress key labelled  .

b) Display will now alternate between `prn` and `end` (Print Field End).

1) To Print Field End, depress key labelled  .

2) While `end` is displayed, if Field Begin is required, depress key labelled  to toggle display to `begn`.

c) Momentarily depress  to advance to RATE CHANGE ALARM ON/OFF.

**C) RATE CHANGE ALARM ON/OFF**

a) Display will alternate between `rate` and `on` (Rate Change Alarm On).

b) Depressing  momentarily changes the display between `on` and `off`. A value of `on` means alarm is enabled; a value of `off` means alarm is disabled.

c) Momentarily depress  to advance to GPS FILE REFERENCE.

**D) GPS FILE REFERENCE**

a) Display will alternate between `file` and `1` (GPS File Reference 1).

b) Enter the GPS file number.

c) Momentarily depress  to advance to GPS OPTIONS.

**E) GPS OPTIONS**

a) GPS is inactive when the display alternates between `gps` and `inac`. The GPS features are explained further in the GRID APPLICATION SYSTEM MANUAL.

b) Momentarily depress  to advance to FIELD REFERENCE.

**F) FIELD REFERENCE**

a) Display will alternate between `fref` and `0` (Field Reference 0).

b) Enter the field number.

c) Momentarily depress  to advance to BAUD RATE.

**G) BAUD RATE**

a) Display will alternate between `baud` and `9600` (Baud Rate 9600).

b) Depressing  momentarily changes the display between `9600` and `1200`.



c) Momentarily depress  to advance to DATA LOGGER TRIGGER VALUE.

**NOTE:** The TRIGGER VALUE default is "zero". This value must be changed to a desired number ranging from 1-9999. The DATA LOGGER features will not work if this number is not changed.

**H) DATA LOGGER TRIGGER VALUE**

- a) Display will alternate between `trig` and `0` (Data Log Trigger Value 0).
- b) Enter the TRIGGER VALUE.
- c) Momentarily depress  to advance to DATA LOGGER TRIGGER UNITS.

**I) DATA LOGGER TRIGGER UNITS**

- a) Display will alternate between `Unit` and `ft` (Data Log Trigger Units Feet).
- b) Depressing  momentarily changes the display between `ft [metr]` and `seC`. A value that has been chosen as the unit of measurement for the TRIGGER VALUE programmed previously. (`seC` means seconds has been chosen as the unit of measure.)
- c) Momentarily depress  to advance to DATA LOGGER.

**J) DATA LOGGER ON/OFF**



- a) The DATA LOGGER uses the communications strings listed in Appendix 10 to pass data out through the serial port. The data is sent at a set time interval or a set distance traveled, as determined by the values entered in the DATA LOGGER TRIGGER VALUE and DATA LOGGER TRIGGER UNITS. Upon each trigger, the Actual Rate string, Data Strings 1, 2, and 3, and the Time/Date string are sent, in that order. When a Console Calibration value is changed, the Console will automatically send out the Cal 1, 2, and 3 strings. When a Console switch is changed, the Data 1, 2, 3, Time/Date, and Cal 1, 2, 3 strings will be sent by the Console. The Data (with Time/Date string included) and Cal strings can also be requested by the data logger using the request strings shown in Appendix 10.





**NOTE:** Some options within the DATA MENU LISTINGS may be unavailable if certain features are ON or active. The options affected are:

CONSOLE DATA PRINTOUT: Console Data Printout will not be available when DATA LOGGER is ON or when GPS functions are active.

GPS OPTIONS: GPS options will not be available when DATA LOGGER is ON.

DATA LOGGER: DATA LOGGER will not be available when GPS functions are active.

- b) Display will alternate between `dlog` and `off` (Data Log Off).
- c) Depressing  momentarily changes the display between `off` and `on`. A value of `off` means DATA LOGGER is disabled; a value of `on` means DATA LOGGER is enabled.
- d) Momentarily depress  to advance to TIME.

- K) ENTER TIME**
- a) Select TIME.
  - b) Enter TIME when display flashes *time*.
  - c) Momentarily depress  to advance to MONTH.
- L) ENTER MONTH**
- a) Select MONTH.
  - b) Enter MONTH when display flashes *onth*.
  - c) Momentarily depress  to advance to DAY.
- M) ENTER DAY**
- a) Select DAY.
  - b) Enter DAY when display flashes *day*.
  - c) Momentarily depress  to advance to YEAR.
- N) ENTER YEAR**
- a) Select YEAR.
  - b) Enter YEAR when display flashes *year*.
  - c) Momentarily depress  to advance to PRINT FIELD BEGIN.
- O) POWER DOWN**  
Sets number of days of inactivity before console goes into low power consumption mode and time settings are lost.

**13) FEATURES UNDER KEY **

To display information relating to the initial programming of the console, press and hold key  for 5 seconds. The display will scroll through the settings for the following:

- US, SI or TU
- SP1 or SP2
- L1, GR1 or GR2

# INITIAL INJECTION SET-UP

- 1) Fill Injection Module Tank with water.
- 2) Place the 3-way valve handle on Injection Pump to the "injection" position on Injection Module.
- 3) Place MASTER ON/OFF switch to ON and BOOM ON/OFF switches to OFF.
- 4) Place OFF/HOLD/RUN switch to HOLD on SCS SIDEKICK.
- 5) Verify correct Boom Widths, SPEED CALS, METER CALS, VALVE CALS, and RATE CALS have been entered into each Console.
- 6) Run main carrier pump at normal operating RPM.
- 7) Verify that each BOOM ON/OFF Valve operates and that no nozzles are plugged by operating Boom ON/OFF switches. (MASTER switch must be ON).
- 8) Enter a SELF TEST speed equal to that of normal operating speed in both Consoles, verify entry by depressing SPEED (6 MPH [9.6 km/h] is recommended). (See Self Test mode under "SPEED" in "OTHER DISPLAY FEATURES").
- 9) Place all BOOM ON/OFF switches to ON.
- 10) Set injection Rate on SCS SIDEKICK for desired oz/acre [dl/ha] of application.
- 11) Place SCS SIDEKICK OFF/HOLD/RUN switch to RUN. The SCS SIDEKICK Console display should display a reading.
- 12) The system will seek the desired rate.
- 13) Enter a SELF TEST speed 2 MPH [3.2 km/h] greater than that initially programmed (8.0 MPH) [12.9 km/h]. The system will automatically correct for this speed variation.
- 14) Turn one BOOM ON/OFF switch to OFF position. The system will automatically correct for this change in boom lengths.
- 15) Repeat Steps 11 thru 16 for all remaining injection products.
- 16) To verify at any time that the Injection Pump is properly calibrated, refer to PROCEDURE TO RE-CALIBRATE PUMP.
- 17) If you have verified the pumps calibration, drain water from Injection Module Tank and add product.

# PREVENTIVE MAINTENANCE

Preventive maintenance is most important to assure long life of the system. The following maintenance procedures should be followed on a regular basis:

- 1) Flush Injection system with clean water after use. Failure to clean system can result in crystallization of products which may foul pump check valves. This may also cause under application.
- 2) Flush and drain system before storing.

**IMPORTANT:** Freezing temperature may damage system if water is not drained.

- 3) Periodically clean strainer on Injection Module.
- 4) Flush Injection system by using flush system (See "RECOMMENDED INJECTION PUMP FLUSH SYSTEM") or by recirculating water through Injection Module until pump is clear of product. When storing at the end of season, recirculate RV antifreeze during the last flush.

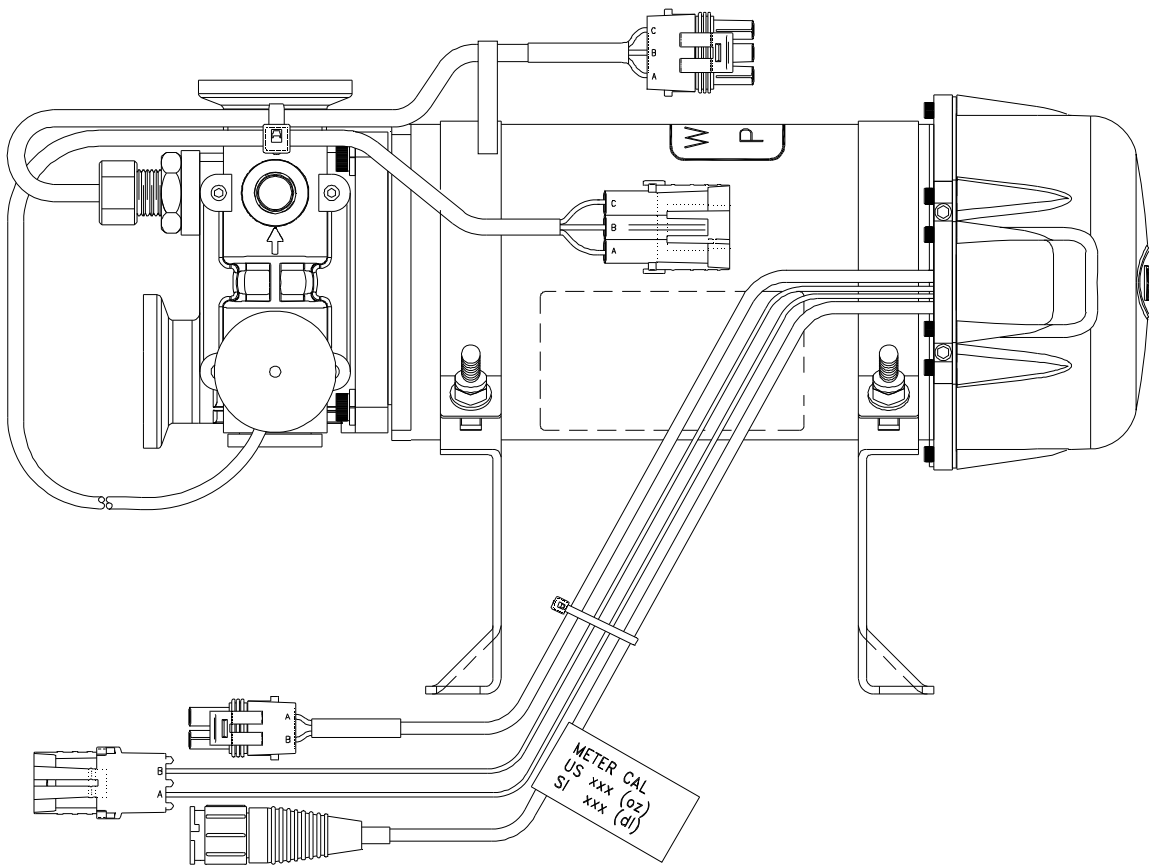

# APPENDIX 1 SIDEKICK INJECTION SYSTEM TROUBLESHOOTING FLOWCHART

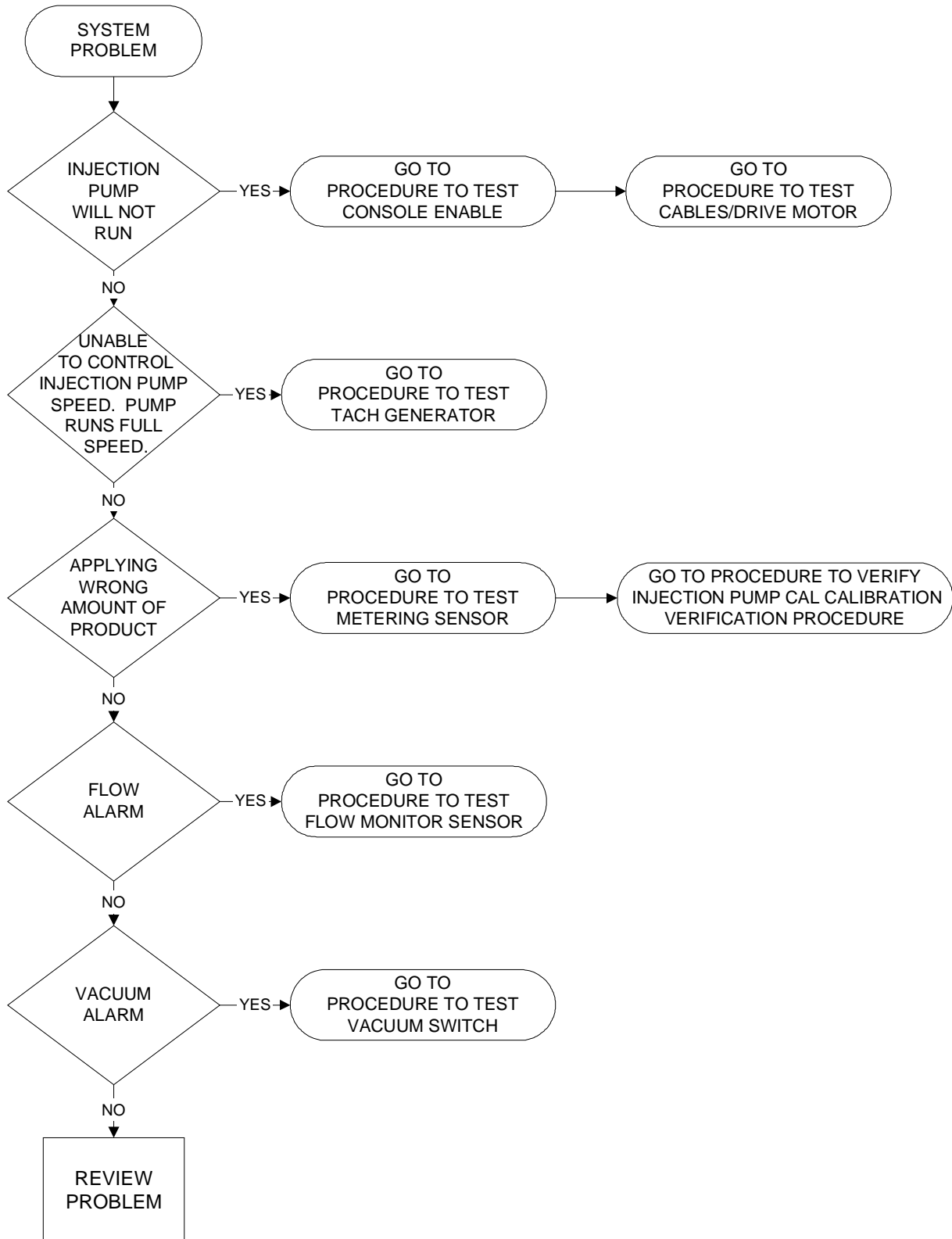

# APPENDIX 2

## PROCEDURE TO TEST CONSOLE ENABLE

- 1) INJECTION PUMP WILL NOT RUN
  - A) Verify OFF/HOLD/RUN switch is in the RUN position.
  - B) The SCS SIEKICK Console must share the Boom On/Off signal with the console it is mated with. 12 VDC equals Boom ON, 0 VDC equals Boom OFF. The Injection pump will not run until the SCS SIDEKICK console receives a Boom ON signal.
  - C) One way to verify the boom signal is being received is to program a large (example: 100.0 mph) in as a simulated speed (see self test feature). Verify the Total Area counts up as the respective boom switches are turned on. The boom switches should be turned ON and then OFF to verify each boom signal is received.

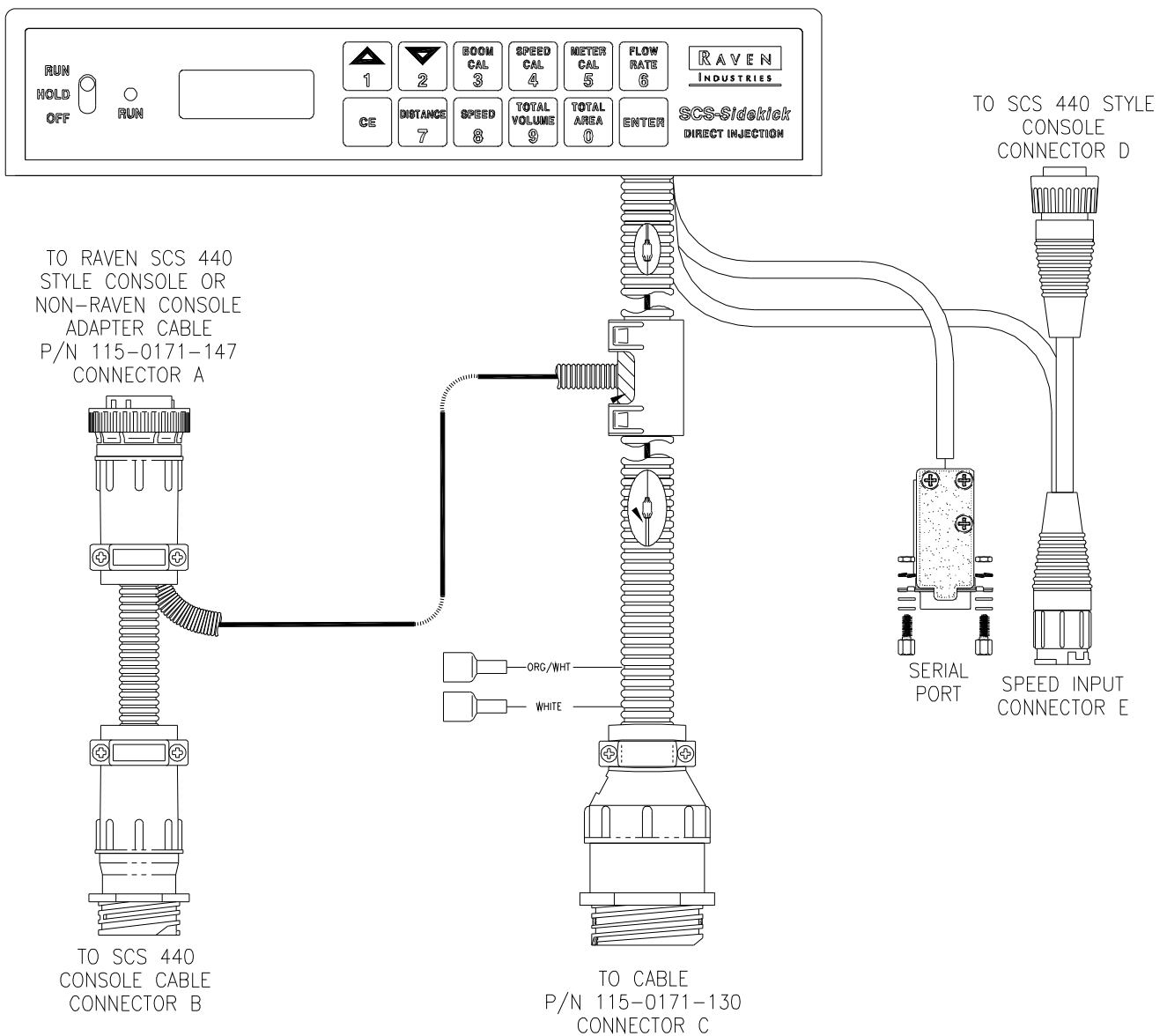



# APPENDIX 3

## PROCEDURE TO TEST CABLES

- 2) INJECTION PUMP WILL NOT RUN (continued)
- A) Ref. cable 115-0171-130 & 115-0171-138 wiring diagram (console cable & product cable).
    - 1) Verify 30 amp fuse is good.
    - 2) Verify 12 volts to fuse holder. Verify white wires connected to battery negative.
  - B) Check connectors for corrosion.
  - C) Verify 12 VDC at Pin A of connector of the Drive Motor. Use Pin B for the negative voltage reference.

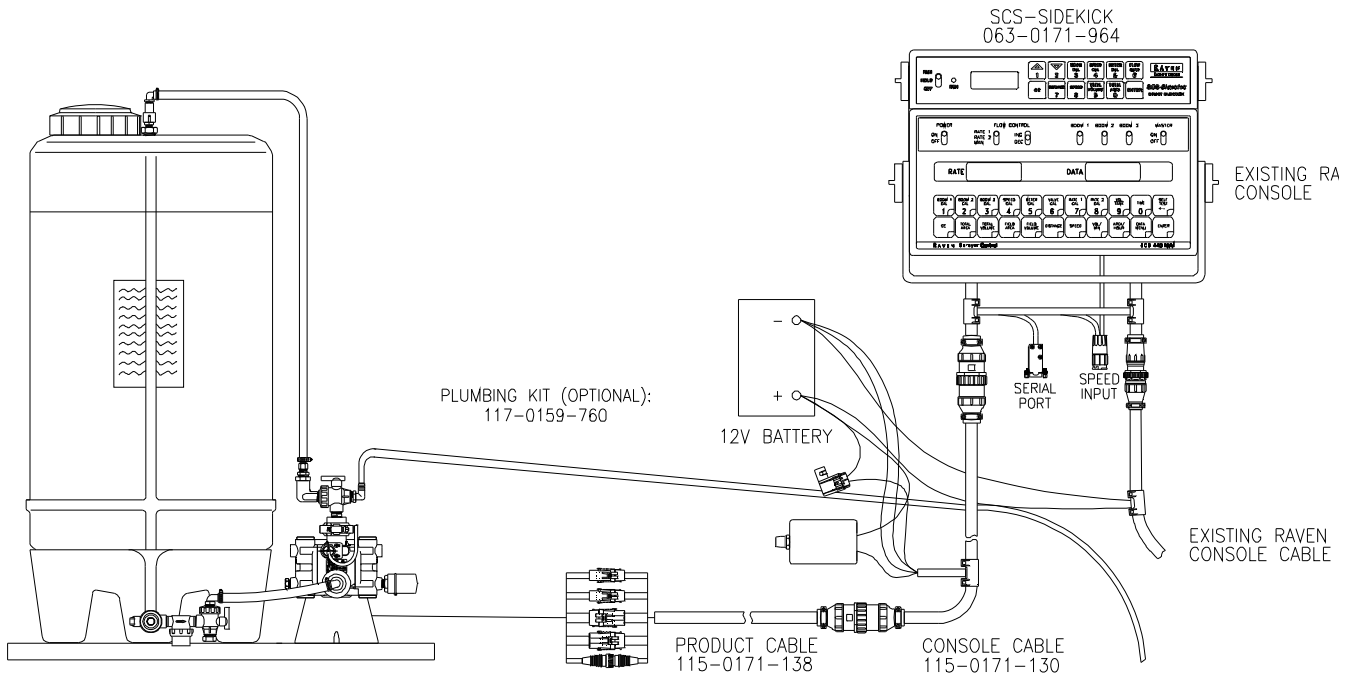

Pin B of the connector going to the Drive Motor is pulsed when the motor is running. This is how the speed of the motor is changed. A pulse that holds pin B to 0 volts for a long time will cause the motor to run faster than a pulse that holds pin B to 0 VDC for a short time.

- D) Drive Motor Test
  - 1) Use the OHM meter function of a multi-meter to measure the resistance of the Drive Motor. It should measure less than 3 ohms.
- E) An other way to test the Drive Motor is to apply 12 VDC to the motor +12 VDC to pin A, 0 VDC to pin B. The motor should run at full rpm.

## APPENDIX 4

### PROCEDURE TO TEST SPEED SENSOR EXTENSION CABLES

Disconnect extension cable from Speed Sensor Assembly cable. Hold extension cable connector so that keyway is pointing in the 12 o'clock position.

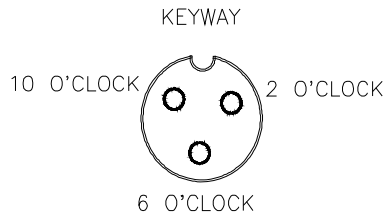

#### PINDESIGNATIONS

2 o'clock socket location is power if SCS Sidekick is connected to an SCS 440 style Console.

10 o'clock socket location is ground.

6 o'clock socket location is signal.



#### VOLTAGEREADINGS

1) 10 o'clock socket to 6 o'clock socket = +5 VDC.

2) 10 o'clock socket to 2 o'clock socket = +5 VDC.

If a +5 VDC voltage reading is not present, disconnect the Flow Sensor cable. If the Speed reading is restored, Test the Flow Sensor cable per Appendix "PROCEDURE TO TEST FLOW METER CABLES".

#### PROCEDURE TO CHECK CABLE:

- 1) Enter SPEED CAL number of 9999 in key labelled: 
- 2) Depress key labelled: 
- 3) With small jumper wire (or paper clip), short between the 10 o'clock and 6 o'clock sockets with a "short-no-short" motion. Each time a contact is made, the DISTANCE total should increase by increments of 1 or more counts.
- 4) Perform above voltage checks.
- 5) If DISTANCE does not increase, remove the section of cable and repeat test at connector next closest to Console. Replace defective cable as required.
- 6) If all cables test good, replace Speed Sensor.

**NOTE:** After testing is complete, re-enter correct SPEED CAL number before application.

# APPENDIX 5

## PROCEDURE TO TEST METERING SENSOR CABLES

Disconnect cable from Metering Sensor. Hold Metering Sensor cable so that the keyway is pointing in the 12 o'clock position:

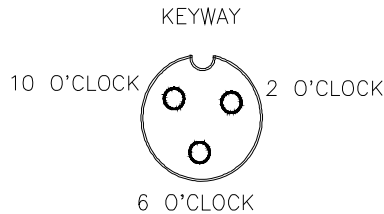

### PIN DESIGNATIONS



- 2 o'clock socket location is ground.
- 10 o'clock socket location is power.
- 6 o'clock socket location is signal.

### VOLTAGE READINGS

- 1) 2 o'clock socket to 6 o'clock socket = +5 VDC.
- 2) 2 o'clock socket to 10 o'clock socket = +5 VDC.

If a +5 VDC voltage reading is not present, disconnect the Speed Sensor cable. If the Flow reading is restored, Test the Speed Sensor cable per Appendix "PROCEDURE TO TEST SPEED SENSOR EXTENSION CABLES".

### PROCEDURE TO CHECK CABLE:

- 1) Enter a METER CAL number of one (1) in key labelled: 
- 2) Depress key labelled: 
- 3) Place BOOM switches and MASTER switch of mating console to ON.
- 4) With small jumper wire (or paper clip), short between the 2 o'clock and 6 o'clock sockets with a "short-no short" motion. Each time a contact is made, the TOTAL VOLUME should increase by increments of 1 or more counts.
- 5) Perform above voltage checks.
- 6) If TOTAL VOLUME does not increase, remove the section of cable and repeat test at connector next closest to Console. Replace defective cable as required.
- 7) If all cables test good, replace Metering Sensor.

**NOTE:** After testing is complete, re-enter correct METER CAL numbers before application.

# APPENDIX 6

## PROCEDURE TO TEST TACH GENERATOR

P/N 063-0159-784 OR P/N 063-0172-312



To locate Tach Generator location, see PUMP/MOTOR ASSEMBLY REPLACEMENT PARTS sheet.

- 1) Flush injection system with water. Ensure that system is free of all chemicals and that there is water in chemical tank. Place Injection Module hand valves to the re-circulate position.

**NOTE:** Position console switches as follows:

SCS 440, Boom 1 switch "ON", Master switch "ON".

SCS SIDEKICK, OFF/HOLD/RUN switch to "RUN". Program the SCS Sidekick in manual control.

- 2) Injection module should now be running. If you can change pump speed by using the  and  keys, the Tach Generator is good. If you can not, proceed to step 3. Refer to Automatic Rate +/- in console programming.
- 3) Position the Master switch to "OFF". Disconnect the cable coming from the Feedback Generator. Connect a DC volt meter to the Tach Generator leads, positive to pin A, negative to pin B. Position the Master switch to "ON". The volt meter should read at least 9 volts. If not, replace the Feedback Generator.

**NOTE:** If the Feedback Generator is good and the injection module was not running at full speed before the Feedback Generator was disconnected, it is normal for the injection module to run at full speed with the Tach Generator disconnected.

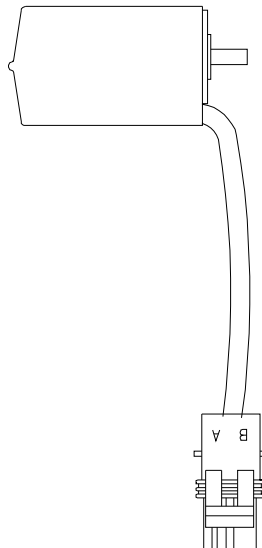

# APPENDIX 7



## PROCEDURE TO TEST METERING SENSOR

063-0171-669 or 063-0172-351

To verify Metering Sensor location see REPLACEMENT PARTS sheet for PUMP/MOTOR ASSEMBLY.

**NOTE:** A cable test should be performed on the main harness prior to testing the Metering Sensor. A cable test is identical to the "Procedure to Test Product Flow Cables".

Disconnect the 2 pin connector of Motor from the Product Cable. This is done as a safety measure to guard against the chance of starting the Injection Module during the test.

- 1) Enter a METER CAL number of "10" in key labelled .
- 2) Turn the Master Switch and Boom 1 Switch to "ON". Place the OFF/HOLD/RUN switch of the SCS Sidekick Console to RUN
- 3) Rotate printed magnet wheel by hand.
- 4) Depress  and display should increment by 2 per revolution of the pump. If not, replace the Metering Sensor.

**NOTE:** If Injection Module is over-applying or under-applying product, it may be necessary to clean the intake and discharge valves. Verify programming calibration numbers when either over-applying or under-applying.

# APPENDIX 8

## PROCEDURE TO RE-CALIBRATE PUMP

- 1) Enter 50 into the METER CAL key on the SCS SIDEKICK Console.
- 2) Place 3-way valve handle on Injection Pump to recirculate position.
- 3) Place BOOM and MASTER switches ON. Place the OFF/HOLD/RUN switch to RUN.
- 4) Run pump until liquid appears from tank return hose. Place OFF/HOLD/RUN switch to HOLD.
- 5) Enter "0" into TOTAL VOLUME key.
- 6) Place tank return hose into measuring container.
- 7) Place OFF/HOLD/RUN switch to RUN until 50 ounces of measured product is pumped. The number displayed in TOTAL VOLUME is the new METER CAL.
- 8) Enter this new METER CAL number in METER CAL key.
- 9) Enter "0" in TOTAL VOLUME key.
- 10) Place OFF/HOLD/RUN switch to RUN until 50 ounces of measured product is pumped.
- 11) The number in TOTAL VOLUME should be 49, 50, or 51. If not, repeat calibration procedures.
- 12) Empty tank return hose into measuring container.
- 13) Pour product caught in measuring container back into Injection Module Tank.

**NOTE:** A. Typical causes for Injection System to under apply are:

1. Fouled Pump Check Valves.
2. Air leaks on Injection Pump inlet plumbing.
3. Air entrained in chemical.
4. Plugged inlet strainer.
5. Chemical is too thick to flow thru inlet plumbing.

B. Typical cause for over application:  
Incorrect calibration data entered into Console.

CALIBRATION FLASK  
106-0159-454

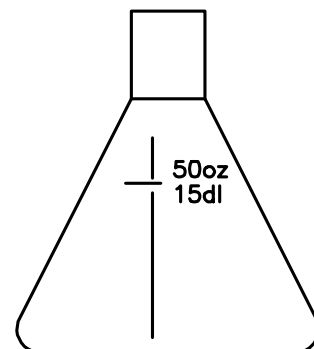

# APPENDIX 9

## PROCEDURE TO TEST FLOW MONITOR SENSOR

P/N 063-0171-979

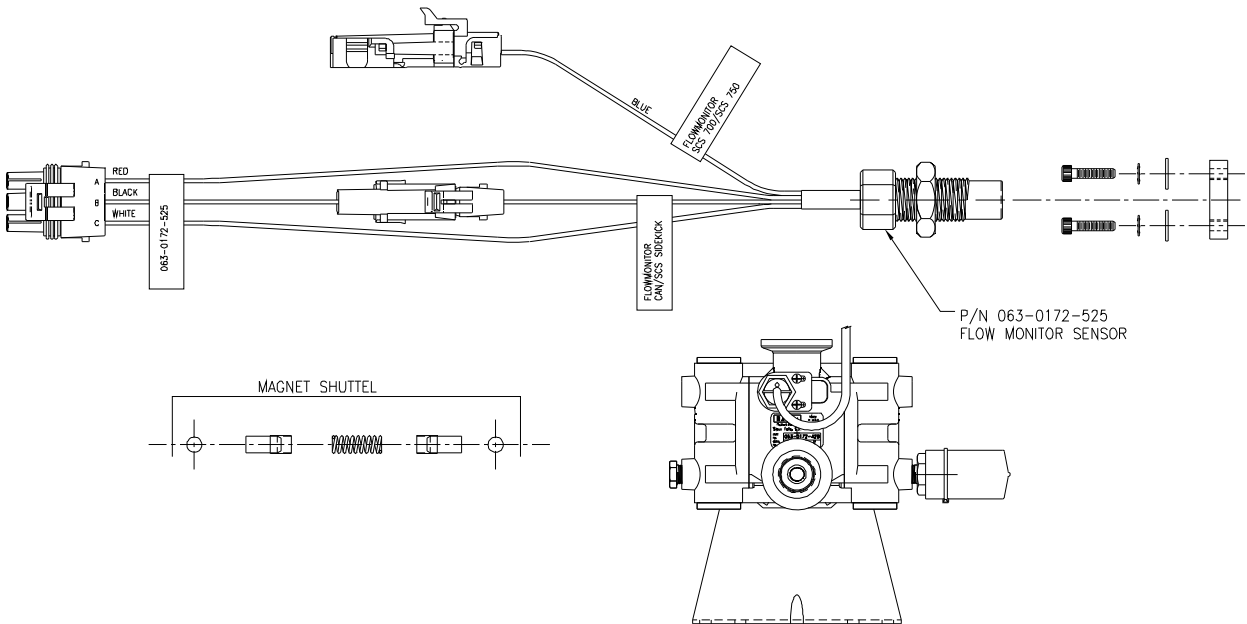

- 1) The above drawing represents the Flow Monitor Manifold found inside the RAVEN SIDEKICK pump. In operation, the magnet shuttle moves back and forth inside the flow monitor manifold as fluid is pumped. The Flow Monitor Sensor detects the magnet's movement when a north and south pole pass by the face of the Flow Monitor Sensor. A red LED flashes, indicating the detection of the moving magnet shuttle.
  - 2) The SCS SIDEKICK Console monitors the Flow Monitor Sensor output. In order for the flow alarm not to sound, the console must see a pulse from the Flow Monitor Sensor as indicated by the flashing LED on the sensor or also indicated by the run light on the console. If the LED is in a steady ON state or a steady OFF state, the flow alarm will be ON. In some cases, the problem can be solved by adjusting the Flow Monitor Sensor to the left or the right. In other cases, the magnetic shuttle may need to be cleaned. Refer to: SENSITIVITY ADJUSTMENT PROCEDURE, MANIFOLD FLOW MONITOR SENSOR.
  - 3) To test the sensor by itself:
    - a) Remove the sensor from the manifold.
    - b) Disconnect the 2 pin connector from the drive motor.
    - c) Position the Sidekick's OFF/HOLD/RUN switch to RUN. On the SCS 440 Console, position the Master switch and the Boom 1 switch to ON. The flow alarm on the Sidekick console will come on.
    - d) Using a magnet, alternate the north pole, then the south pole against the face of the sensor. As the Flow Monitor Sensor detects the magnets changing polarity, verify the LED on the sensor changes from ON to OFF. The flow alarm on the Console should also be silent as long as the Flow Monitor Sensor's LED flashes.
  - 4) The pin out of the sensor is as follows:  
A = +12 VDC; B = Signal; C = 0 VDC
  - 5) To test this portion of the cables, make and break a short between pins A and B. If the cable is good, the run LED on the console will flash.
- NOTE:** Position console switches as indicated in step 3 above.

## APPENDIX 10

### SENSITIVITY ADJUSTMENT PROCEDURE, MANIFOLD FLOW MONITOR SENSOR

- 1) Position injection modules hand valve to recirculate. Run pump to prime system. Inspect for any leaks. Repair as necessary.
- 2) Monitor volume per minute. Manually adjust pump output to 5 oz. per minute.
- 3) Visually monitor LED on manifold sensor. Adjust manifold sensor left or right until LED flashes. Tighten screws on bracket. See below.
- 4) Verify LED continues to flash.
- 5) Manually adjust pump output to 40 oz/min. Verify LED continues to flash.
- 6) During normal operation LED shall flash. If pump pumps on only one cylinder, LED will no longer flash. Flow error message will be displayed on console.
- 7) Return hand valve to injection position.

**NOTE:** To read vol/min, refer to SIDEKICK CONSOLE manual.

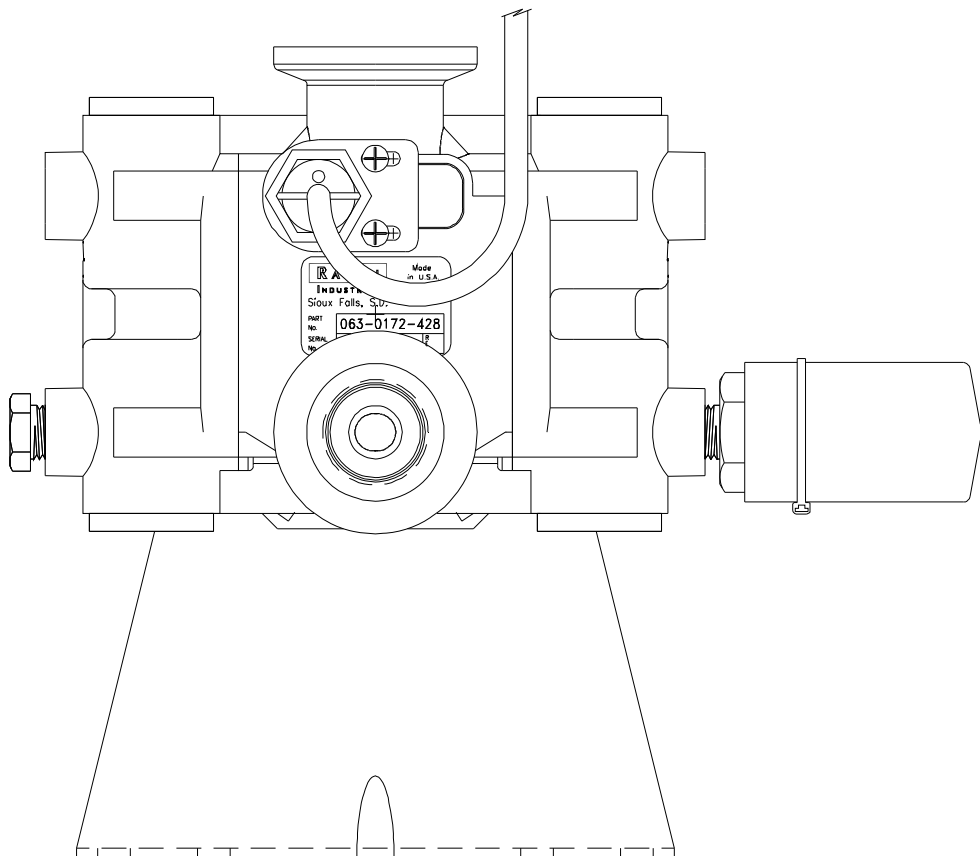



# APPENDIX 11

## PROCEDURE TO TEST VACUUM SWITCH

063-0171-035

To verify Vacuum Sensor location see ULTRA LOW VOLUME INJECTION MODULE ASSEMBLY REPLACEMENT PARTS sheet for low volume units or HIGH VOLUME INJECTION MODULE ASSEMBLY REPLACEMENT PARTS sheet for high volume units.

- 1) Disconnect the Vacuum Switch from product cable.
- 2) Test for continuity between pins A and C of the Vacuum Switch. If the OHM meter reads a short, the switch is good, if it reads an open, the Vacuum Switch is bad.

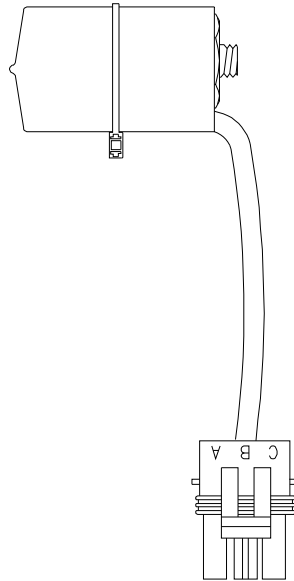

**NOTE:** The Vacuum Switch is a normally closed circuit.

Schematic Symbol: ———— A ———— C ———— (Pin B not used)

# APPENDIX 12

## ALTERNATIVE TANK SELECTION

Tank must be of a shape and design that does not permit the tank outlet to un-cover when the vehicle goes up and down steep grades or when sloshing when product in tank is low.

The tank should be capable of complete drainage.

Generally speaking, a tall, narrow (length and width) tank is best. Cone bottom tanks work well also.

### PLUMBING TANK

- 1) Pump must be gravity fed with a flooded inlet.
- 2) Keep plumbing short and avoid running hose up and down. (See below) This will trap air and could cause pump to air lock.
- 3) Use 3/4" hose between tank and pump.
- 4) A strainer with 20 mesh screen must be used on pump inlet.
- 5) Provide for tank drainage and incorporate 3-way valves that will allow pump to be flushed with clean water. See below.
- 6) Provide a 3-way valve on pump outlet to allow for a recirculation/calibration position and an injection position.

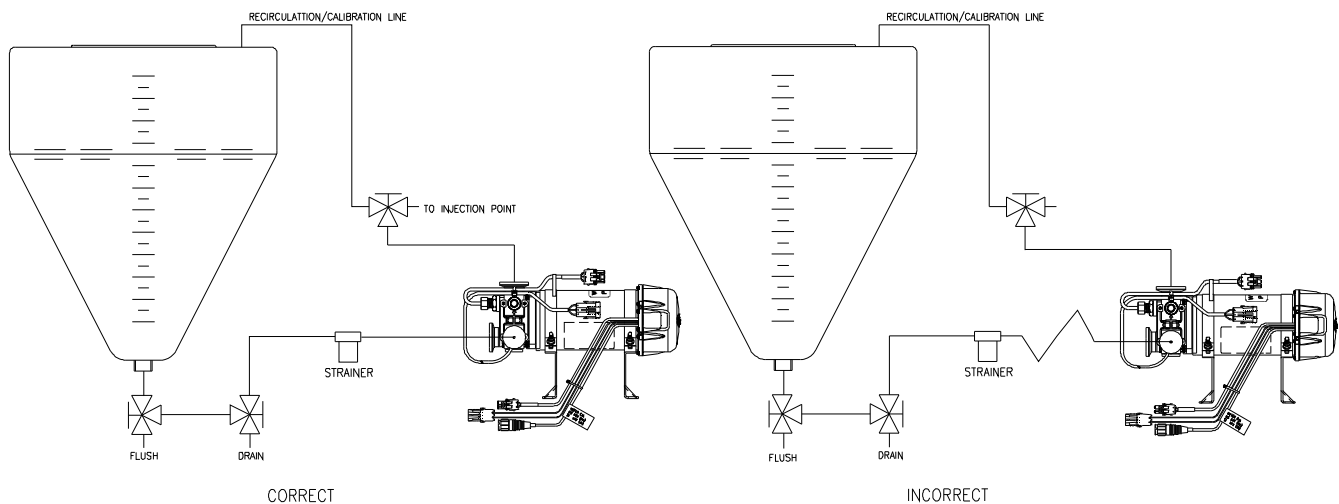

# APPENDIX 13 SERIALINTERFACE

- 1) Cable pinout (P/N 115-0159-994), supplied with Thermal Printer Kit (P/N 117-0159-529).



- 2) Changing RATE 1 CAL by remote computer.  
a) Configuration of RS-232C serial port:

1200 or 9600 Baud Rate  
NO Parity  
8 Data Bits  
2 Stop Bits

- b) Data stream to Raven Console.

**EXAMPLE:** Change RATE 1 to 123.4

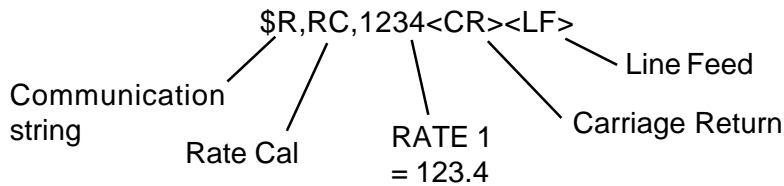

Decimal point is not sent from Remote Computer to Raven Console.

- 3) Optional 9 pin to 9 pin cable pinout (P/N 115-0159-822).

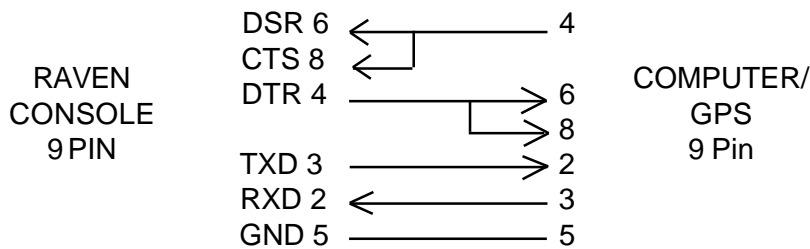

# APPENDIX 14

## SCS-SIDEKICK COMMUNICATION STRINGS

### REMOTE COMPUTER TO SCS-SIDEKICK CONSOLE

All request strings begin with \$R, to indicate a Raven communication string.

**Rate 1 Change Request:**

\$R,RC,<rate\_1\_cal><CR><LF>

**Calibration String Values Request:**

\$R,CR<CR><LF>

**Data String Request:**

\$R,DR<CR><LF>

**Time Request:**

\$R,TR<CR><LF>

**Time Acknowledge Request:**

\$R,TA<CR><LF>

### SCS-SIDEKICK CONSOLE TO REMOTE COMPUTER

All console output strings begin with \$R122A, the \$R indicates a Raven communication string, the 122 is the last three digits of the current SCS-SIDEKICK programmed chip part number and A is the software revision number.

**Calibration Strings:**

\$R122A,C1,<switch\_byte\_1>,<switch\_byte\_2>,<boom\_1\_cal>,  
 <boom\_2\_cal>,<boom\_3\_cal>,<boom\_4\_cal>,<boom\_5\_cal>,  
 <boom\_6\_cal>,<boom\_7\_cal>,<speed\_cal><CR><LF>  
 \$R122A,C2,<meter\_cal>,<CR><LF>  
 \$R122A,C3,<valve\_cal>,<rate\_1\_cal><CR><LF>

Bit	Switch Byte 1	Switch Byte 2
0	boom 1	0
1	boom 2	0
2	boom 3	0
3	boom 4	rate 1
4	boom 5	0
5	boom 6	0
6	boom 7	0
7	1	1

**NOTE:** If rate 1 is zero, the console is in Manual.  
 For switch Byte Bits; 0 = off and 1 = on.

**Data Strings:**

\$R122A,D1,<total\_area><CR><LF>  
 \$R122A,D2,<total\_volume><CR><LF>  
 \$R122A,D3,<distance><CR><LF>

**Actual Rate:**

\$R122A,AR,<actual\_rate><CR><LF>

**Time/Date:**

\$R122A,TD,<hr:min>,<month/day/year>,<field\_reference><CR><LF>

**Notes:**

# SCS SIDEKICK PLUMBING INSTALLATION AND REPLACEMENT PARTS

ITEM	DESCRIPTION	RAVEN PART #
1	Fitting, Elbow, Street	333-0007-031
2	Valve, 3 Way 1/2" Poly	334-0001-037
3	Fitting, Plug, 1/2" Poly	333-0009-063
4	Fitting, Elbow 1/2" NPT x 3/4" HB	333-0002-048
5	Fitting, Strainer 1/2"	333-9000-008
6	Gasket, M100	219-0000-129
7	Hose Clamp	435-3003-003
8	Hose, EVA 3/4"	Not Supplied in Kit
9	Fitting, Elbow, Flanged	333-0002-200
10	Fitting, Nozzle Nipple	333-0008-164
11	Check Valve	333-0011-001
12	Teflon Washer	313-2202-460
13	Fitting, Hose Shank 3/8"	333-0002-061
14	Fitting, Nozzle Cap	333-0009-028
15	Hose Clamp	435-3003-002
16	Hose, EVA 3/8"	Not Supplied in Kit
17	Fitting, Bushing 3/4 X 1/4 Poly	333-0003-039
18	Fitting, Nozzle Body	333-0002-901
19	Fitting, Elbow 1/4 NPT X 3/8 HB Poly	333-0002-040
20	Cap & Gasket	333-0002-902
21	Washer, Flat 1/4" SS	313-2301-810
22	Washer, Lock 1/4" SS	313-1000-017
23	Bolt 1/4-20 UNC X 5/8 SS	311-0050-202
24	Washer, Lock Internal Tooth SS	313-3000-032
25	Fitting, Elbow HB	333-0002-047
26	Fitting, Nipple 1/2" X 4" SS	107-0159-907
27	Bushing 3/4" X 1/2" Poly	333-0003-071
28	Nut 1/4-20 Hex SS	312-1001-033
29	Fitting, Flanged	333-0002-201
30	Clamp, V-Band	435-3003-044
31	Fitting, Nipple	333-0008-154
32	Valve 3-Way Continuous Flow	334-0001-054

## NOTES:

1. This kit is intended to aid with installing Raven Injection Pumps to a non-Raven tank. Not all fittings shown may be relevant.
2. Assemble parts as shown. Use pipe sealant on all fittings.
3. Please note valve item 41 must be installed on the outlet side of the pump for recirculation. This valve has a blue dot in the handle for identification.

# SCS SIDEKICK PLUMBING INSTALLATION AND REPLACEMENT PARTS

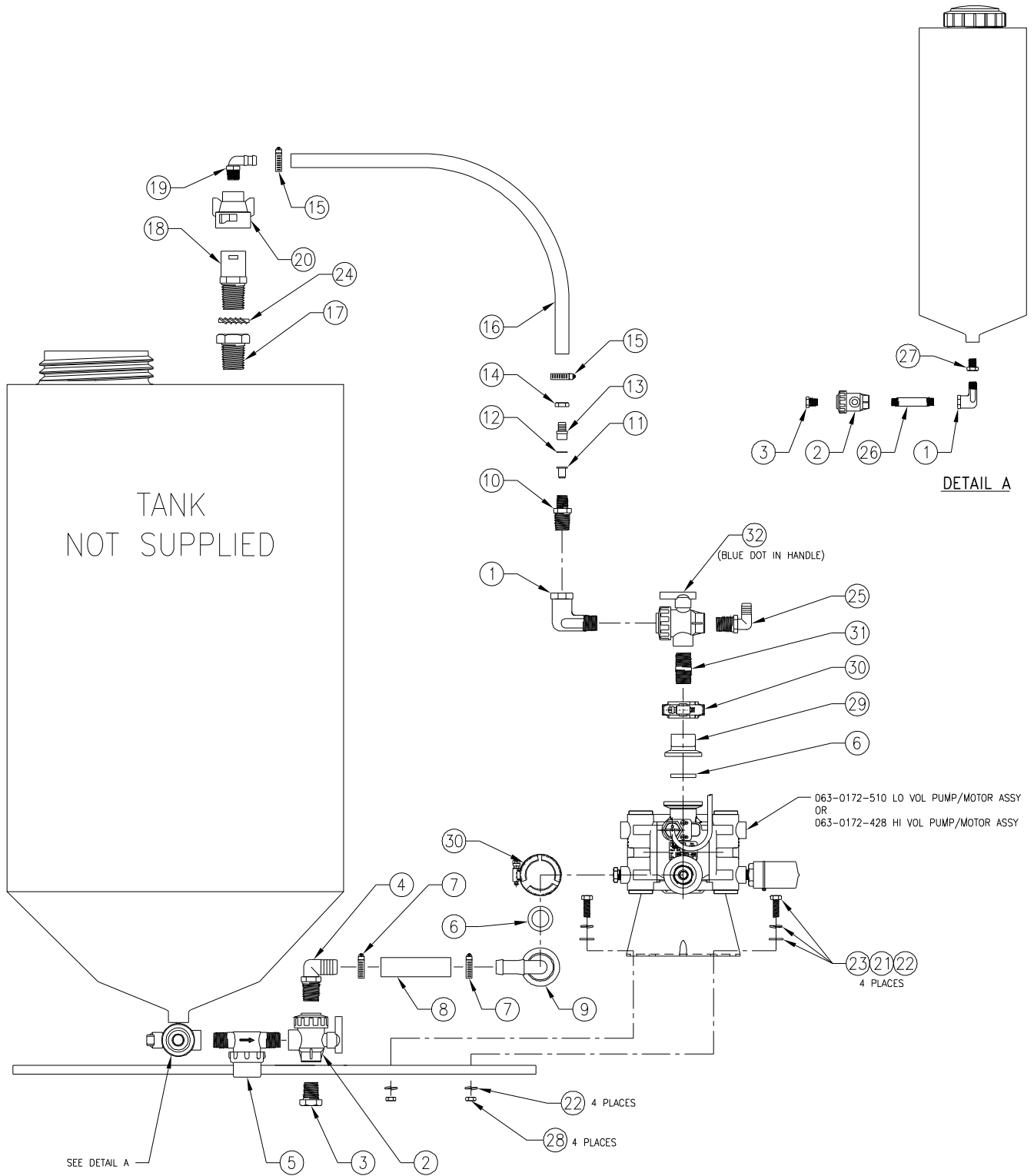

016-0159-820

# MODULE, SCS-SIDEKICK DIRECT INJECTION, HIGH VOLUME REPLACEMENT PARTS

063-0172-511

ITEM	DESCRIPTION	RAVEN PART #
1	Weldment, Platform	116-0159-484
2	Module, Pump/Motor	063-0172-428
3	Tube, Formed Upright	107-0171-374
4	Strap, Tank Mounting, Stainless	107-0171-375
5	Bolt, J-Hook	321-0000-316
6	Plug, 3/4"	333-0009-064
7	Tank, 24 Gal.	118-0159-016
8	Cover, Fillwell	118-0159-043
9	Saddle, Molded	118-0159-007
10	Valve, 3-Way	334-0001-037
11	Valve, 1 PSI Check	333-0011-001
12	Fitting, Nipple 1/2" x 4"	107-0159-907
13	Bushing, 3/4" x 1/2"	333-0003-071
14	Street Elbow, 1/2"	333-0007-031
15	Plug, 1/2"	333-0009-063
16	Fitting, Flanged	333-0002-201
17	Elbow, 3/4" HB x 1/2" NPT	333-0002-048
18	Strainer, 1/2"	333-9000-008
19	Clamp, V-Band, FC-100	435-3003-044
20	Fitting, Elbow, Flanged M-100 x 3/4" HB 90°	333-0002-200
21	Gasket, M-100	219-0000-129
22	Nozzle Nipple	333-0008-164
23	Hose Shank	333-0002-061
24	Nozzle Cap	333-0009-028
25	Bushing, 3/4" to 1/4"	333-0003-039
26	Nozzle Body	333-0002-901
27	Elbow, 1/4" NPT to 3/4" Hosebarb	333-0002-040
28	Hose, 3/4" EVA	214-0001-005
29	Hose, 3/8" EVA	214-0001-002
30	Hose Clamp	435-3003-003
31	Hose Clamp	435-3003-002
32	Teflon Washer	313-2202-460
33	Cap	333-0002-902
34	Bolt, 1/4-20 x 1"	311-0050-105
35	Bolt, 5/16-18 x 1 3/4"	311-0052-108
36	Bolt, 1/4-20 x 5/8"	311-0050-202
37	Valve, 3-Way	334-0001-054
38	Washer	313-2300-012
39	Nipple	333-0008-154
40	Washer	313-2301-810
41	Lock Washer 1/4"	313-1000-017
42	Hex Nut, 5/16-18, Nylon Lock	312-4000-059
43	Star Washer 14mm External	313-3000-032
44	Fitting, Elbow, Hosebarb	333-0002-047
45	Washer, Fender	313-2300-124

054-0159-314



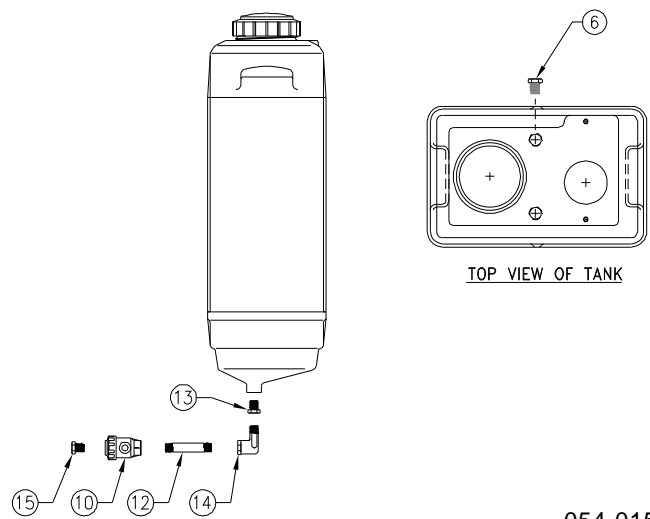
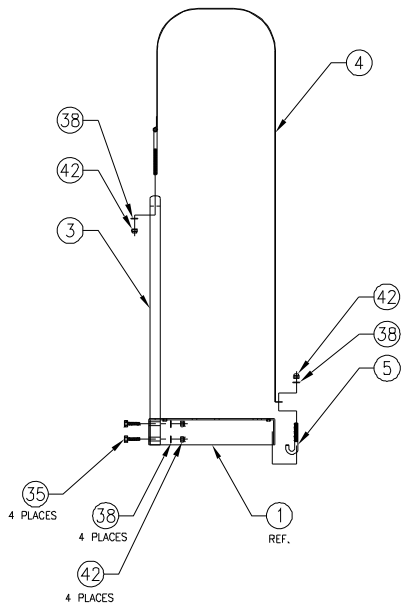
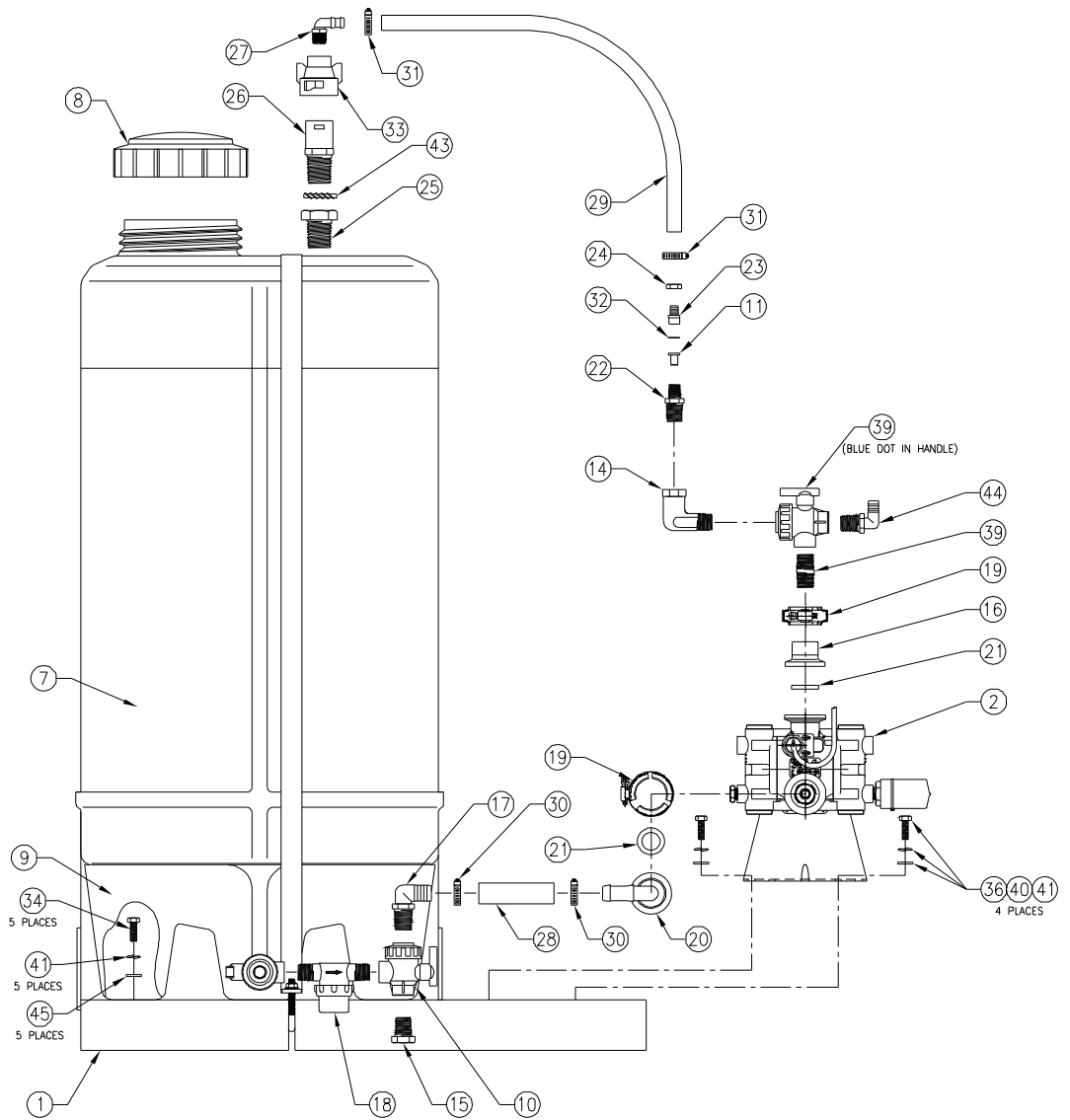

054-0159-314

# RAVEN INJECTION PUMP, 5-200 oz/min. REPLACEMENT PARTS

063-0172-428

ITEM	DESCRIPTION	RAVEN PART #
1	Motor/Tach Assembly	063-0172-500
2	Bearing Assembly	063-0172-501
3	Key	107-0171-588
4	O-Ring	219-0001-153
5	Bracket, Mounting, Pump/Motor	107-0171-589
6	Label, Meter Cal	041-0159-718
7	Strap	107-0171-594
8	Washer, Internal Tooth, Lock 1/4" SS	313-3000-017
9	Screw, Socket Heat, Cap 1/4"-20 x 3/4"	311-0073-066
10	Cartridge, Intake	063-0172-503
11	Cartridge, Discharge	063-0172-504
12	Bracket, Sensor	106-0159-539
13	Screw	311-0004-040
14	Label, Serial	041-0159-710
15	Tie, Cable	435-1000-003
16	Cap, Tapered	118-0159-041
17	Thread Sealant Loctite #242	222-1001-029
18	Screw, Cap, Hex Socket Head 1/4-20 x 1/4	311-0068-060
19	Manual (Not Shown)	016-0159-975
20	Grease, Lubricating, Versilube	222-0000-002
21	Bolt, 1/4"-20 x 1"	311-0069-004
22	Washer	313-2300-009
23	Nut	312-4000-057
24	Anti-Sieze Compound, Nickel	222-1001-079
25	Grease	222-1001-114
26	Sensor, Universal, Flowmonitor	063-0172-525

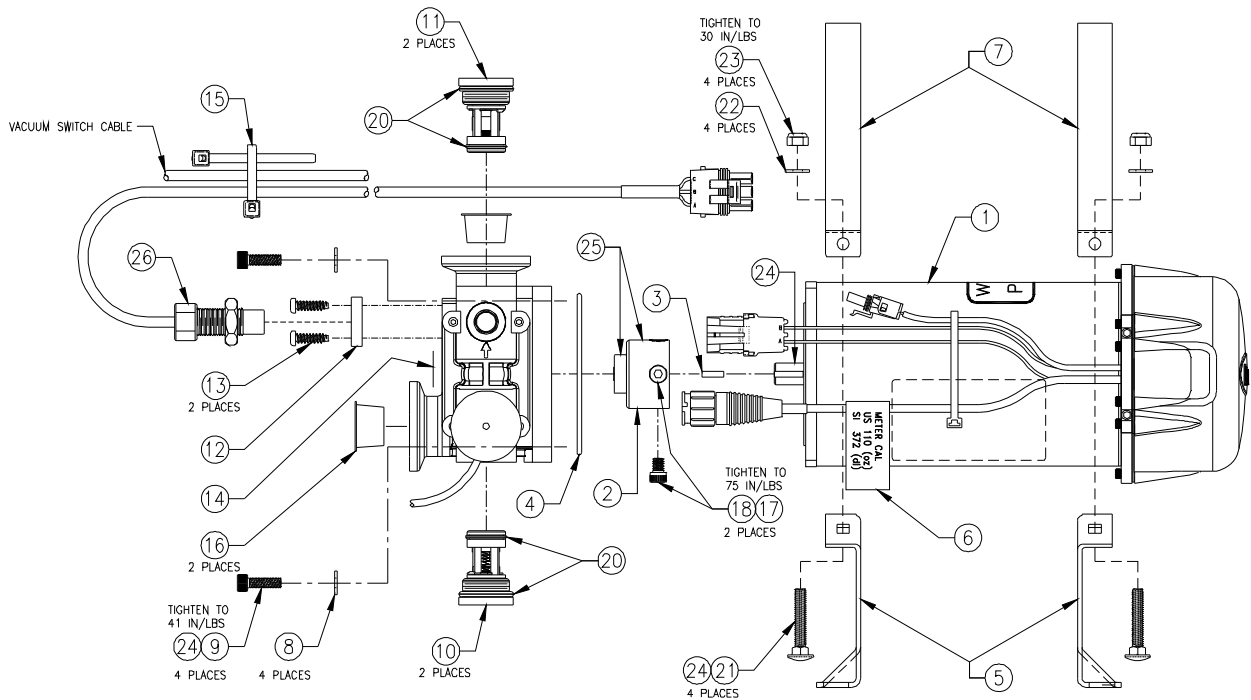

054-0159-290

# RAVEN INJECTION PUMP, 5-200 oz/min. REPLACEMENT PARTS

063-0172-428

ITEM	DESCRIPTION	RAVEN PART #
1	Housing, 3/4" Injection Pump	107-0171-523
2	Bearing, Piston	325-0000-018
3	Piston, 3/4" Pump	107-0171-531
4	Seal, Slipper	219-0000-125
5	O-Ring	219-0007-117
6	O-Ring	219-0002-015
7	Spring	314-0000-012
8	Magnet Assembly	063-0172-518
9	Ball	321-0000-313
10	Head, 3/4" Pump	107-0171-526
11	Screw 10-24 x 1 1/2" SS	311-0068-191
12	Anti-Sieze Compound, Nickel	222-1001-079
13	Washer, Internal Tooth Lock	313-3000-014
14	Switch, Vacuum	063-0171-035
15	Plug, Hex, Pipe	333-0009-061
16	Seal Kit (Not Shown)	117-0159-987

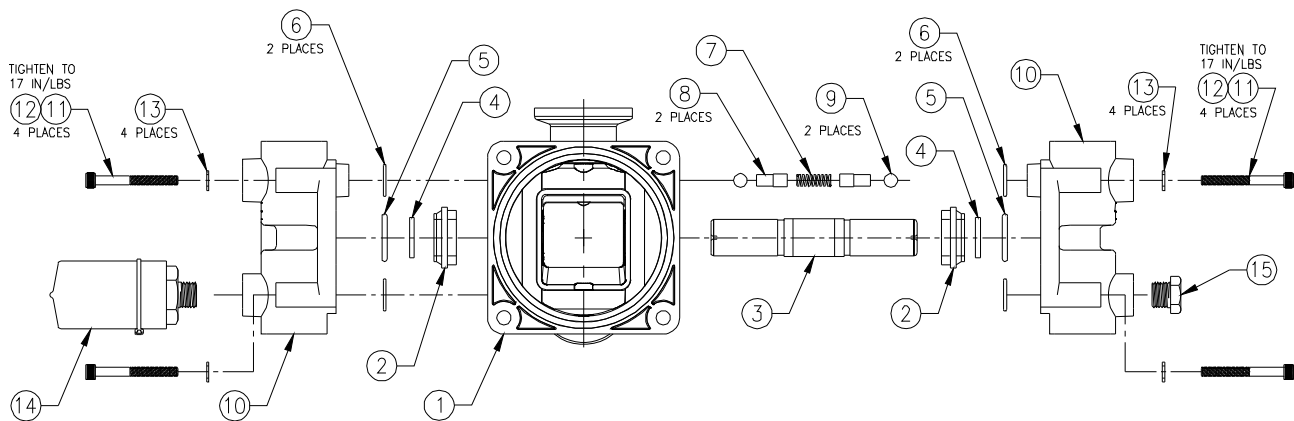

054-0159-290

# RAVEN INJECTION PUMP, 1-40 oz/min. REPLACEMENT PARTS

063-0172-510

ITEM	DESCRIPTION	RAVEN PART #
1	Motor/Tach Assembly	063-0172-527
2	Bearing Assembly	063-0172-501
3	Key	107-0171-588
4	O-Ring	219-0001-153
5	Bracket, Mounting, Pump/Motor	107-0171-599
6	Label, Meter Cal	041-0159-720
7	Strap	107-0171-600
8	Washer, Internal Tooth, Lock 1/4" SS	313-3000-017
9	Screw, Socket Head, Cap 1/4"-20 x 3/4"	311-0073-066
10	Cartridge, Intake	063-0172-503
11	Cartridge, Exhaust	063-0172-504
12	Bracket, Sensor	106-0159-539
13	Screw	311-0004-040
14	Grease	222-1001-114
15	Sensor, Universal, Flowmonitor	063-0172-525
16	Label, Serial	041-0159-721
17	Tie, Cable	435-1000-003
18	Cap, Tapered	118-0159-041
19	Thread Sealant Loctite #242	222-1001-029
20	Screw, Cap, Hex Socket Head 1/4-20 x 1/4	311-0068-060
21	Manual (Not Shown)	016-0159-975
22	Grease, Lubricating, Versilube	222-0000-002
23	Bolt, 1/4"-20 x 1"	311-0069-004
24	Washer	313-2300-009
25	Nut	312-4000-057

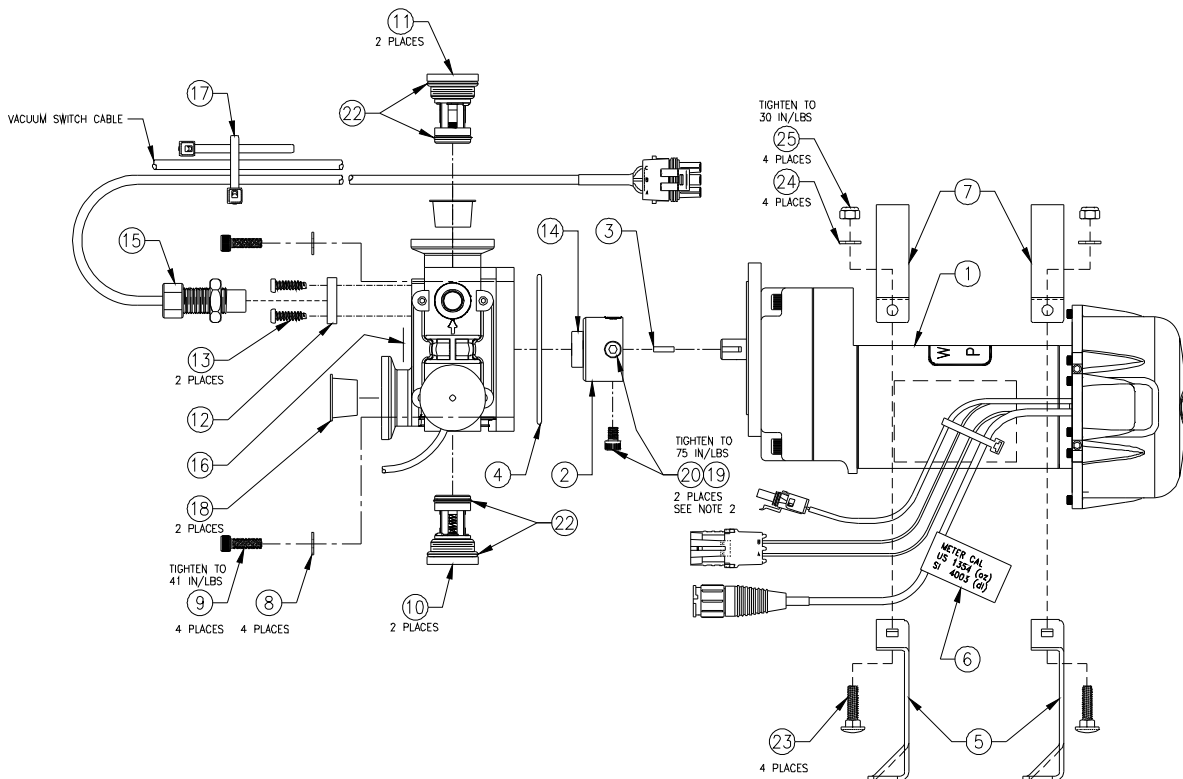

054-0159-291

# RAVEN INJECTION PUMP, 1-40 oz/min. REPLACEMENT PARTS

063-0172-510

ITEM	DESCRIPTION	RAVEN PART #
1	Housing, 3/4" Injection Pump	107-0171-523
2	Bearing, Piston	325-0000-018
3	Piston, 3/4" Pump	107-0171-531
4	Seal, Slipper	219-0000-125
5	O-Ring	219-0007-117
6	O-Ring	219-0002-015
7	Spring	314-0000-012
8	Magnet Assembly	063-0172-518
9	Ball	321-0000-313
10	Head, 3/4" Pump	107-0171-526
11	Screw 10-24 x 1 1/2" SS	311-0068-191
12	Anti-Sieze Compound, Nickel	222-1001-079
13	Washer, Internal Tooth Lock	313-3000-014
14	Switch, Vacuum	063-0171-035
15	Plug, Hex, Pipe	333-0009-061

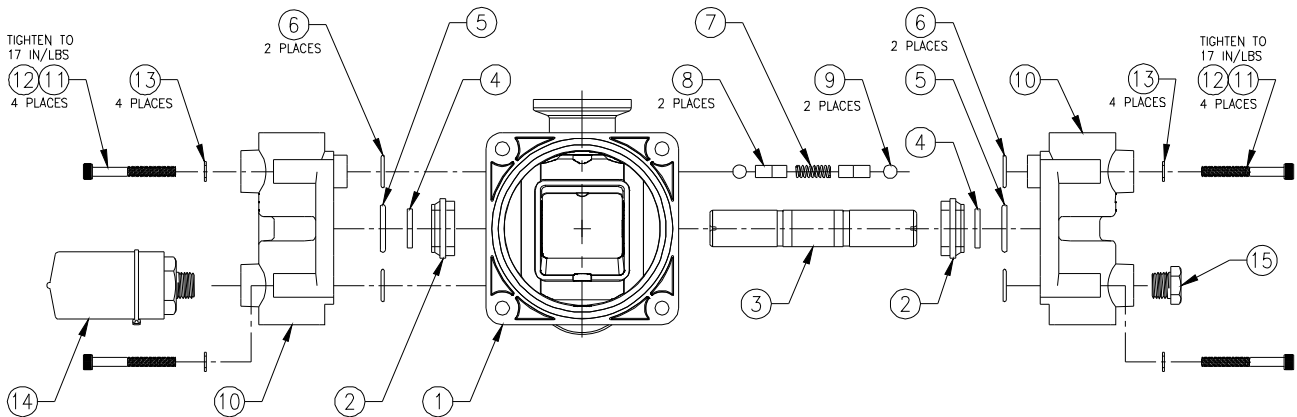

054-0159-291

# MODULE, SCS-SIDEKICK DIRECT INJECTION, LOW VOLUME REPLACEMENT PARTS

063-0172-512

ITEM	DESCRIPTION	RAVEN PART #
1	Weldment, Platform	116-0159-484
2	Module, Pump/Motor	063-0172-510
3	Tube, Formed Upright	107-0171-374
4	Strap, Tank Mounting, Stainless	107-0171-375
5	Bolt, J-Hook	321-0000-316
6	Plug, 3/4"	333-0009-064
7	Tank, 24 Gal.	118-0159-016
8	Cover, Fillwell	118-0159-043
9	Saddle, Molded	118-0159-007
10	Valve, 3-Way	334-0001-037
11	Valve, 1 PSI Check	333-0011-001
12	Fitting, Nipple 1/2" x 4"	107-0159-907
13	Bushing, 3/4" x 1/2"	333-0003-071
14	Street Elbow, 1/2"	333-0007-031
15	Plug, 1/2"	333-0009-063
16	Fitting, Flanged	333-0002-201
17	Elbow, 3/4" HB x 1/2" NPT	333-0002-048
18	Strainer, 1/2"	333-9000-008
19	Clamp, V-Band, FC-100	435-3003-044
20	Fitting, Elbow, Flanged M-100 x 3/4" HB 90°	333-0002-200
21	Gasket, M-100	219-0000-129
22	Nozzle Nipple	333-0008-164
23	Hose Shank	333-0002-061
24	Nozzle Cap	333-0009-028
25	Bushing, 3/4" to 1/4"	333-0003-039
26	Nozzle Body	333-0002-901
27	Elbow, 1/4" NPT to 3/4" Hosebarb	333-0002-040
28	Hose, 3/4" EVA	214-0001-005
29	Hose, 3/8" EVA	214-0001-002
30	Hose Clamp	435-3003-003
31	Hose Clamp	435-3003-002
32	Teflon Washer	313-2202-460
33	Cap	333-0002-902
34	Bolt, 1/4-20 x 1"	311-0050-105
35	Bolt, 5/16-18 x 1 3/4"	311-0052-108
36	Bolt, 1/4-20 x 5/8"	311-0050-202
37	Valve, 3-Way	334-0001-054
38	Washer	313-2300-012
39	Nipple	333-0008-154
40	Washer	313-2301-810
41	Lock Washer 1/4"	313-1000-017
42	Hex Nut, 5/16-18, Nylon Lock	312-4000-059
43	Star Washer 14mm External	313-3000-032
44	Washer, Fender	313-2300-124
45	Fitting, Elbow, Hosebarb	333-0002-047

054-0159-315

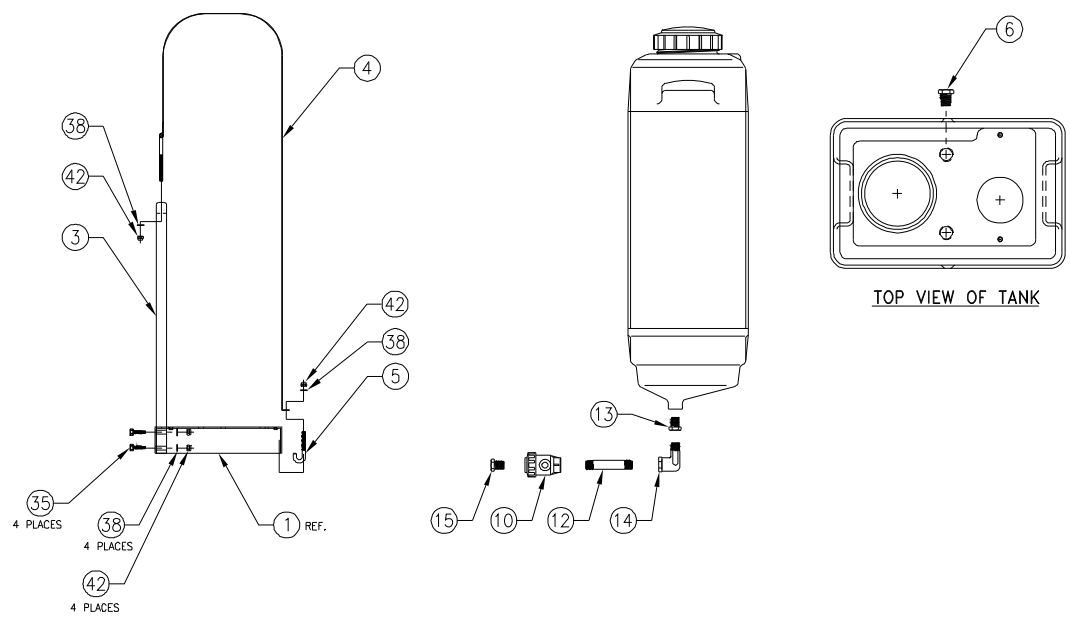
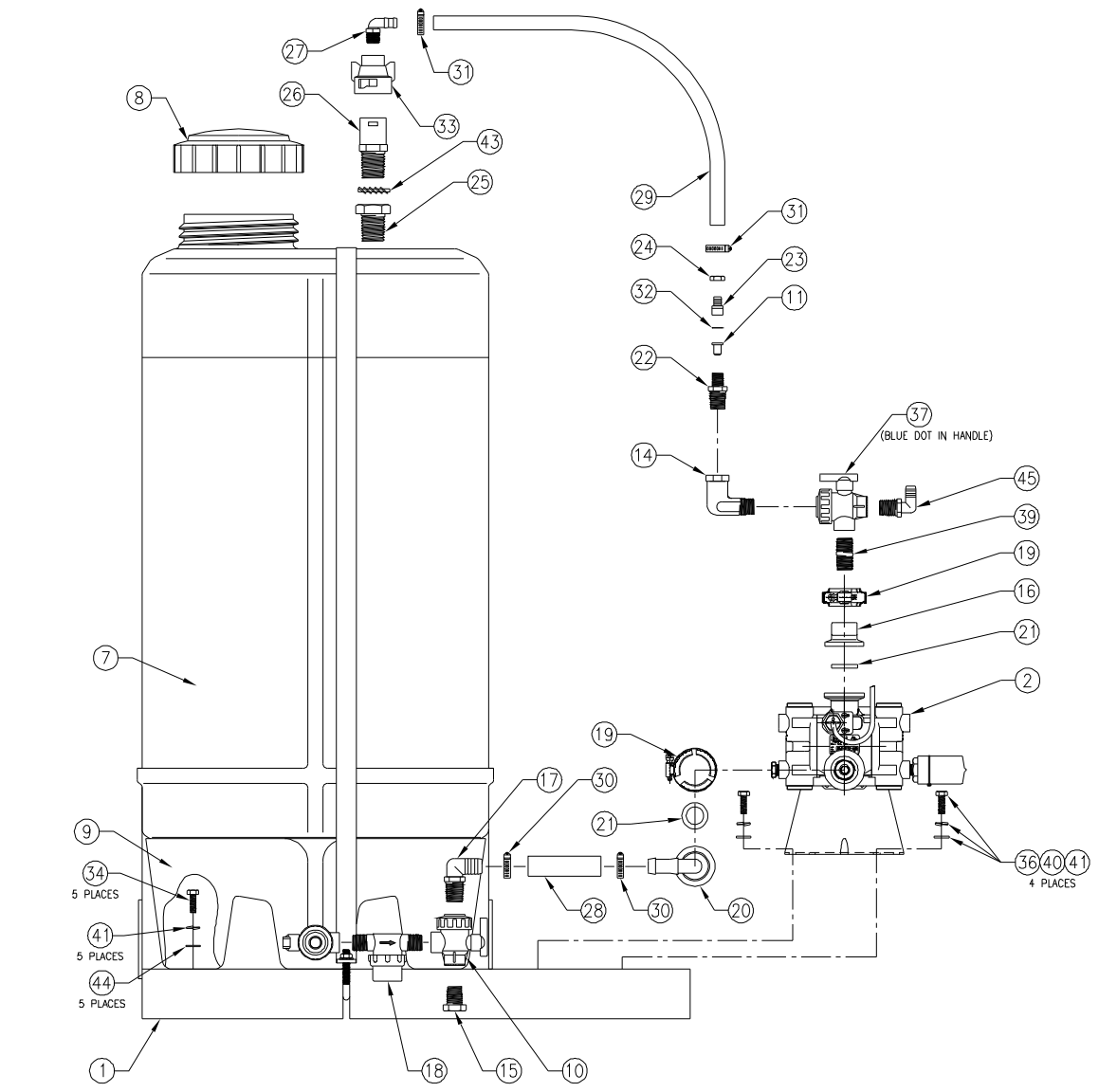

054-0159-315

**Notes:**



**RAVEN**

# **RAVEN INDUSTRIES**

## **Limited Warranty**

---

### ***What Does this Warranty Cover?***

This warranty covers all defects in workmanship or materials in your Raven Applied Technology Product under normal use, maintenance, and service.

### ***How Long is the Coverage Period?***

Raven Applied Technology Products are covered by this warranty for 12 months after the date of purchase. This warranty coverage applies only to the original owner and is nontransferable.

### ***How Can I Get Service?***

Bring the defective part and proof of purchase to your Raven Dealer. If your Dealer agrees with the warranty claim, the Dealer will send the part and proof of purchase to their distributor or to Raven Industries for final approval.

### ***What Will Raven Industries Do?***

Upon confirmation of the warranty claim, Raven Industries will, at our discretion, repair or replace the defective part and pay for return freight.

### ***What is not Covered by this Warranty?***

Raven Industries will not assume any expense or liability for repairs made outside our facilities without written consent. Raven Industries is not responsible for damage to any associated equipment or products and will not be liable for loss of profit or other special damages. The obligation of this warranty is in lieu of all other warranties, expressed or implied, and no person or organization is authorized to assume any liability for Raven Industries.

Damages caused by normal wear and tear, misuse, abuse, neglect, accident, or improper installation and maintenance are not covered by this warranty.

**R A V E N**

SCS Sidekick Injection System  
Installation & Service Manual  
(P/N 016-0159-819 Rev G 7/09)

*Simply improving your position.<sup>SM</sup>*



Raven Industries  
Applied Technology Division  
P.O. Box 5107  
Sioux Falls, SD 57117-5107

Toll Free (U.S. and Canada): (800)-243-5435  
or Outside the U.S. :1 605-575-0722  
Fax: 605-331-0426  
[www.ravenprecision.com](http://www.ravenprecision.com)  
[atdinfo@ravenind.com](mailto:atdinfo@ravenind.com)

Notice: This document and the information provided are the property of Raven Industries, Inc. and may only be used as authorized by Raven Industries, Inc. All rights reserved under copyright laws.