

INDEX

A	PAGE	H	PAGE	R	PAGE
Adjustable Hounds.....	11	Hammer Straps.....	25	Racks, Hay.....	3
Adjustable Tongues.....	10	Hardware, Wagon.....	24	Reaches, Ironed and Painted.....	12
Arms, Binder Reel.....	19	Harrow Bars, Folding.....	13	Reaches, White.....	17
Axles.....	17	Harrow Hooks.....	23	Reel Fans, Binder.....	19
		Harrow Teeth.....	23	Repair Ends, Steel.....	11
B		Hawns, Rear.....	17	Rims, Wagon.....	16
Bars, Hay Loader.....	18	Hawns, Tongue.....	17	Rods, Wagon Box.....	24
Beams, Cultivator.....	17	Hay Loader Slats and Bars.....	18		
Boards, Shoveling.....	8-9	Hay Racks.....	3	S	
Bolster Irons.....	25	Hay Rack Fixtures.....	23	Sandboards.....	17
Bolster Plates, Hay Rack.....	25	Hay Sling Bars.....	18	Shoveling Boards.....	8-9
Bolsters, Rough or Finished.....	17	Hitches, Heider.....	21	Shoveling Board Parts.....	9
Bolster Stakes, Steel.....	12-25	Hooks, Harrow.....	23	Singletrees, Cultivator.....	20
Bolsters, Trailer.....	12	Hounds, Adjustable.....	11	" Machine.....	20
Bolsters, Truck.....	12			" Plow.....	20
Boxes, Wagon.....	4	I		" Wagon.....	20
Braces, Wagon Box.....	24	Implement Poles.....	14	Singletree Woods.....	15
Bumpers, Disc.....	23			Singletree Parts.....	25
Bushings, Machinery and Split.....	25-26	J		Slats, Canvas.....	19
		Joint, Tongue.....	11	Slats, Manure Spreader.....	18
C				Split Washers.....	26
Canvas Slats.....	19	K		Spokes, Wagon.....	16
Clamps, Hay Rack.....	23	King Bolts.....	25	Spools, Extension.....	23
Clamps, Truck.....	23			Spools, Spreader.....	23
Clevis.....	22	L		Steel Repair Ends.....	11
Corn Picker Hitch.....	11	Loops, Hay Rack.....	23	Strap Bolts.....	24
Cultivator Beams.....	17			T	
Cultivator Handles.....	16	M		Teeth, Sweep Rake.....	15
		Machine Sets.....	20	Tongues, Adjustable.....	10
D		Machine Set Straps.....	25	Tongue Joints.....	11
Disc Bumpers.....	23	Manure Spreader Slats.....	18	Tongues, Wagon.....	17
Doubletree Plates.....	24	McPhail Hooks.....	25	Tractor Clevis.....	22
Doubletree Sets.....	21			Tractor Hitch.....	11
Doubletree Woods.....	15	N		Trailer Bolster.....	12
Doubletrees.....	21	Neckyokes.....	21	Trailer Hitch.....	12
Dump Endgates.....	8-9	Neckyoke Parts.....	25	Truck Clamps.....	23
		Neckyoke Woods.....	15	Truck Wagon Bolsters.....	12
E				W	
Endgates.....	12	P		Wagon Boxes.....	4
Endgates, Dump.....	8-9	Pitmans, Binder.....	19	Wagon Poles.....	17
Evener Sets, Machine.....	20	Pitman Woods, Mower.....	19	Wagon Tongues, Adjustable.....	10
Evener Woods.....	15	Pitman Woods, Pump Jack.....	18	Wagon Box Anti-Spread Chain.....	24
Eye Bolts, Harrow.....	23	Plow Handles.....	16	" Bevel Edge Iron.....	24
Extension Spools.....	23	Plow Sets, Doubletree.....	21	" Braces.....	24
		Pockets, Hay Rack.....	23	" Endgate Fasteners.....	24
F		Pole Caps.....	24	" Grain Cleats.....	24
Fans, Binder Reel.....	19	Poles, Implement.....	14	" Hinges.....	24
Fixtures, Hay Rack.....	23	Poles, Wagon.....	17	" Rods.....	24
Flares, Wagon Box.....	23	Pump Rod.....	16	" Rod Nuts.....	24
				" Rod Washers.....	24
G		Q		" Rub Irons.....	24
Grass Boards.....	19	Queen Bolts.....	25	" Staples.....	24
Grass Board Sticks.....	19			" Strap Bolts.....	24
				Wagon Wrenches.....	24
				Washers, Bushing.....	25
				Washers, Split.....	26

DULTMEIER HAY RACK

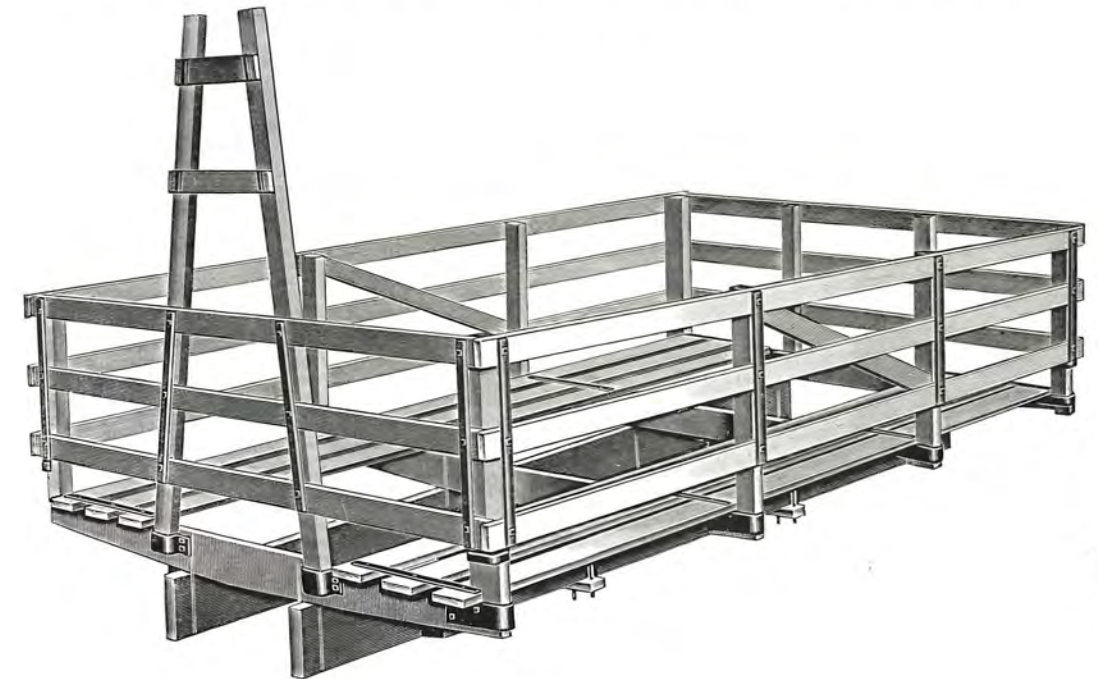

A Sturdy, Dependable "Take Down" Rack That One Man Can Handle Easily

The Dultmeier Hay Rack goes together without bolts, screws or nails and can be taken apart for storing by one man without tools.

The body is finished a golden brown and trimmed in red before it is assembled. Made of high grade fir lumber and equipped throughout with standard bolts, clamps and irons.

Sills are gathered in front for short turning.

SPECIFICATIONS

Main Sills.....	2 x 10
4 x 6 Sills furnished if specified.	
Cross Sills.....	2 x 6
Standards.....	2 x 4
Stakes and Sill Braces.....	2 x 4
Sides.....	1 x 4
Floor Boards.....	1 x 6
Size Overall.....	8' x 14'

Shipped semi-assembled. Six floor boards regularly furnished as illustrated. Weight, about 450 pounds.

No.	Price
310—Regular Rack.....	\$35.35

EXTRAS

For 4 x 4 cross sills, in place of 2 x 6, add.....	\$1.35
For 4 x 6 sills, in place of 2 x 10, add.....	1.15
For Tite Floor between sills, add.....	5.35
For Tite Floor throughout, add.....	8.00
For special braced sides, add.....	1.50
For Rack Less all Floor Boards Illustrated, Deduct.....	3.25



This cut shows the unique method used in the corner construction which permits the Dultmeier Hay Rack to be taken apart easily without tools.

PRE-SEASON TERMS AND CASH DISCOUNTS

(SUBJECT TO CHANGE WITHOUT NOTICE)

The following datings and cash discounts apply only on orders so written as to permit shipment at our convenience during the shipping period designated in each case. All orders for at once shipment carry maximum cash discounts shown for payment within ten days.

HAY RACKS

2%—10 days, Net 30 days.

WAGON BOXES

When shipped prior to Sept. 1st, 5%—10 days, Net 30 days.
When shipped after Sept. 1st, 2%—10 days, Net 30 days.

SHOVELING BOARDS

2%—10 days, Net 30 days.

HARROW BARS

When shipped at our convenience Dec. 1st to Mar. 1st. 2%
April 10th, Net May 1st.

WOOD REPAIR PARTS (Page 19)

When shipped at our convenience Mar. 1st to July 1st. 5%
July 10th, Net August 1st.

SWEEP RAKE TEETH

When shipped at our convenience Jan. 1st to May 1st. 2%
June 10th, Net July 1st.

ALL OTHER ITEMS—Pages 10 to 26

When shipped at our convenience Jan. 1st to Mar. 1st. 2%
Mar. 10th, Net April 1st.

This is a general outline of our schedule of terms. However, the possession of this catalog is not a guarantee on the part of the Dultmeier Manufacturing Company to supply (to the possessor of our catalog) merchandise at the terms and prices shown in this booklet and the price guides that apply to it.

DULTMEIER GRAIN-TITE WAGON BOXES

NO. D80

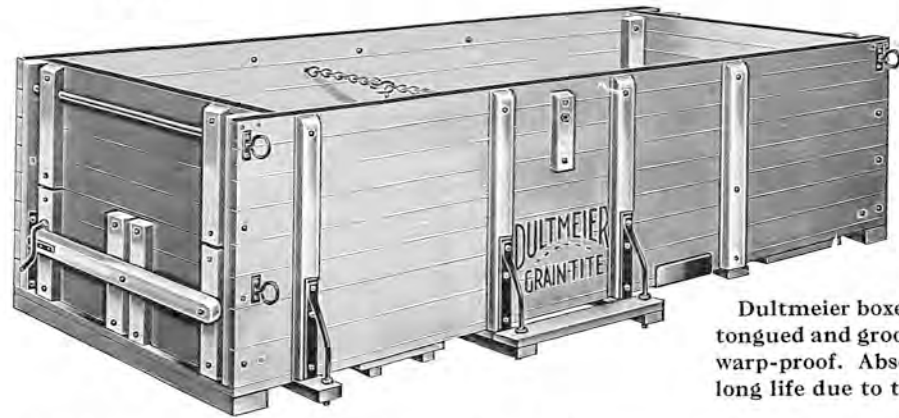

STANDARD SIZE 10' 6" Long
BUILT FOR DURABILITY

Dultmeier boxes are made of clear, kiln-dried, four-inch, tongued and grooved fir flooring, making them shrink- and warp-proof. Absolutely grain tite. These boxes have extra long life due to the rot-resisting nature of fir.

The bottom has six selected hardwood cross sills with double bottom over bolsters.

Each side has 4 hardwood cleats; inside, and outside. Extra brace at rear of each side to prevent bulging when endgate and rods are removed.

The front endgate is a removable one-piece construction. Rear has double endgate, lower half being new truck type. Angle grain cleats.

The Irons are standard weight throughout. Boxes furnished with two coats of varnish, or painted with green enamel, irons red, striped in panel form.

No. D80—26-in. SINGLE PANEL

No.	Aprox. Wgt.	Price
D80—Grain Tite 26" Single Panel, Painted	325	\$34.70
D83—Tip Top—10"	70	10.00
For 1 1/4" Floor, add	20	2.35
Equipped with No. 1126A Dump Endgate, add		.80
Varnished instead of painted: Deduct, D80 Box, \$1.00; D83 Tip Top, \$0.40.		
See Page 8 for Dump Endgate Specifications.		

No. D802

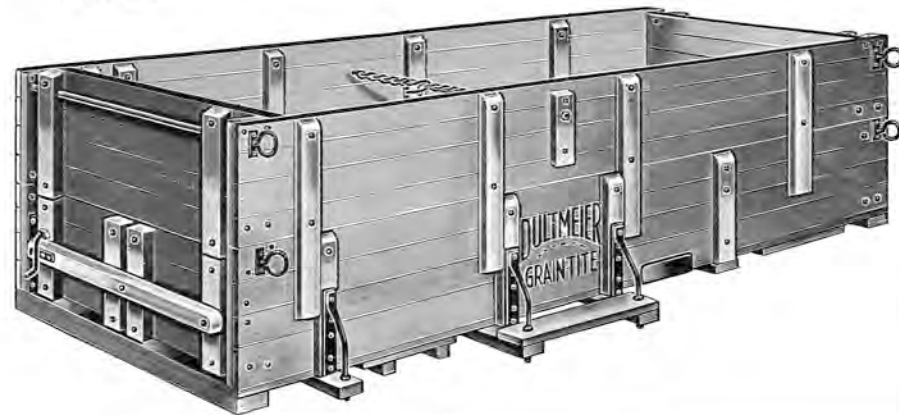

STANDARD SIZE 10' 6" Long
No. D802—26-in. TWO PANEL

The D802 is of the same general construction as the D80, except that the sides while made of four-inch flooring are made in two panel and equipped with angle grain cleats. Furnished painted with Green Enamel, Irons Red, sides striped in panel form.

No.	Aprox. Wgt.	Price
D802—Grain Tite—26" Two Panel, Painted	335	\$37.35
D83 —Tip Top—10"	70	10.00
For 1 1/4" Floor, add	20	2.35

NEW IDEAL WAGON BOXES

No. D85

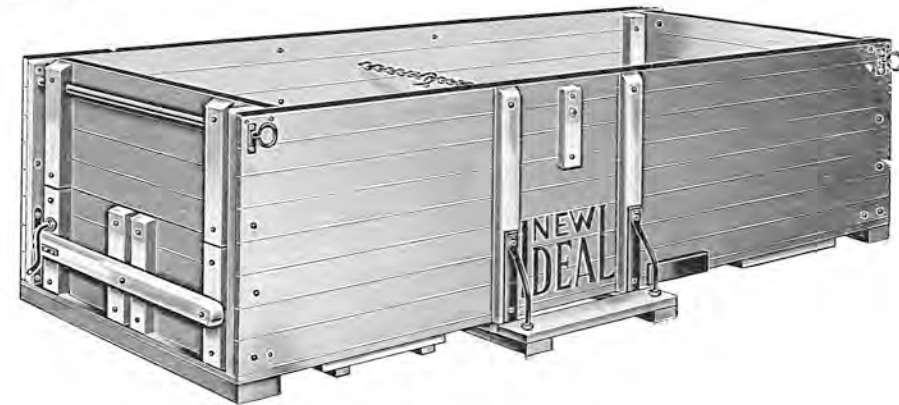

STANDARD SIZE 10' 6" Long

A competitive box built similar to the No. D80, has but 4 cross pieces beneath the bottom and two braces and strap irons on the outside of each side. The same high grade material is used throughout the No. D85 that is used in constructing our No. D80 box. An item to be used in meeting radio competition. Furnished with two coats of varnish or painted with green enamel, irons red, sides striped in panel form.

No. D85—26-in. SINGLE PANEL

No.	Aprox. Wgt.	Price
D85—New Ideal 26" Single Panel, Painted	300	\$32.00
D83—Tip Top—10"	70	10.00
For 1 1/4" Floor, add	20	2.35
Equipped with No. 1126A Dump Endgate, add		.80
Varnished instead of painted: Deduct, No. D85 Box, \$1.00; D83 Tip Top, \$0.40.		
See page 8 for Dump Endgate specifications.		

No. D852

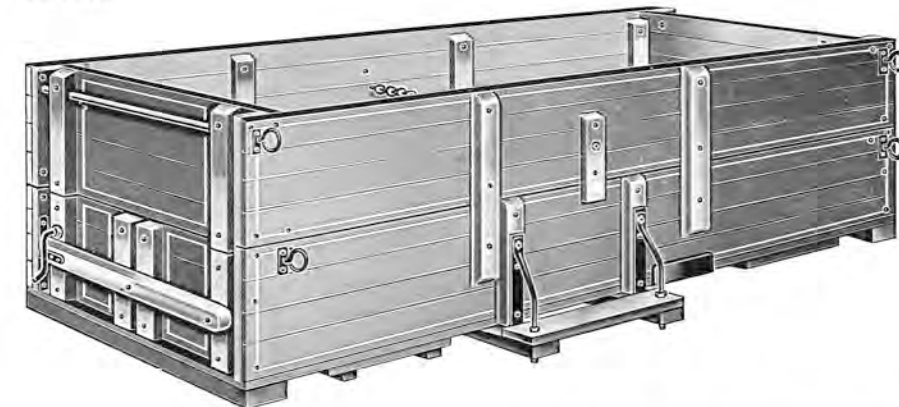

STANDARD SIZE 10' 6" Long

The D852 is of the same general construction as the D85, except that the sides while made of four-inch flooring are made in two panel and equipped with angle grain cleats. Furnished with two coats of varnish only, Irons Red, sides striped in panel form.

No. D852—26-in. TWO PANEL

No.	Aprox. Wgt.	Price
D852—New Ideal—26" Two Panel, Varnished	310	\$34.70
D83V—Tip Top—10", Varnished	70	10.00
For 1 1/4" Floor, add	20	2.35

DULTMEIER IRONCLAD TANK BOX

No. D99

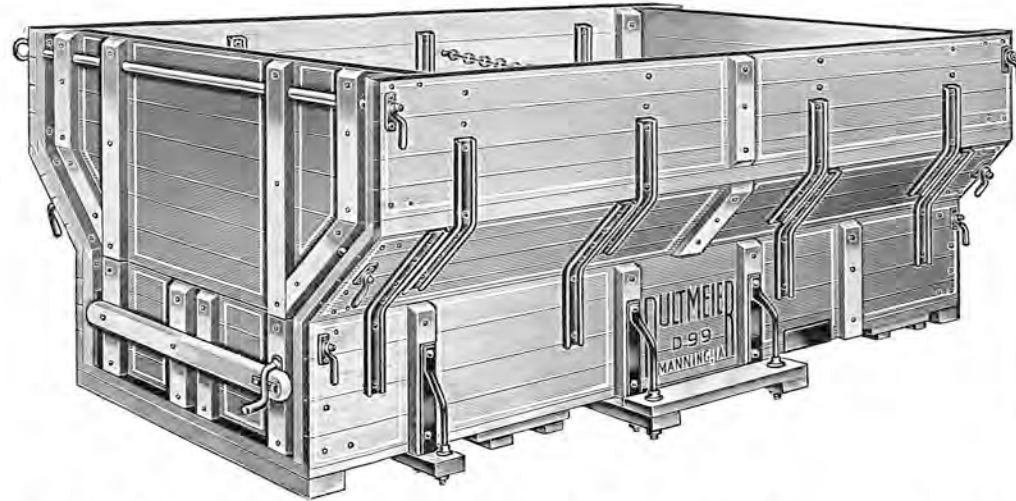

SPECIFICATIONS
 Length, 10'6" outside.
 Depth, 36½" inside.
 Top Width, 52" inside.
 Bottom Width, 36" inside.
 Approximate Capacity:
 100 bushels small grain.
 50 bushels ear corn.

The No. D99 Iron Clad Tank Box is, as the name implies, heavily ironed with a double set of formed channels—a full set bolted at four points, both inside and outside. This box is Grain Tite just as our No. D90, but is much more rigid and durable because it is built with SIX BED SILLS and

extra extension sill braces as used in our No. D80 and D802 standard pattern quality boxes. Can be converted into a standard style box of 28" depth, our No. D99A, which is shown below. Finished in wagon box green and striped in panel form. Irons enameled red.

No.	Approx. Wgt.	Price
D99 —With 1" Floor—Painted.....	450 lbs.	\$56.95
D99-1¼—With 1¼" Floor—Painted.....	475 lbs.	59.30
Equipped with Dump Endgate No. 1126C, add.....		.80

DULTMEIER IRONCLAD 28" BOX

No. D99A

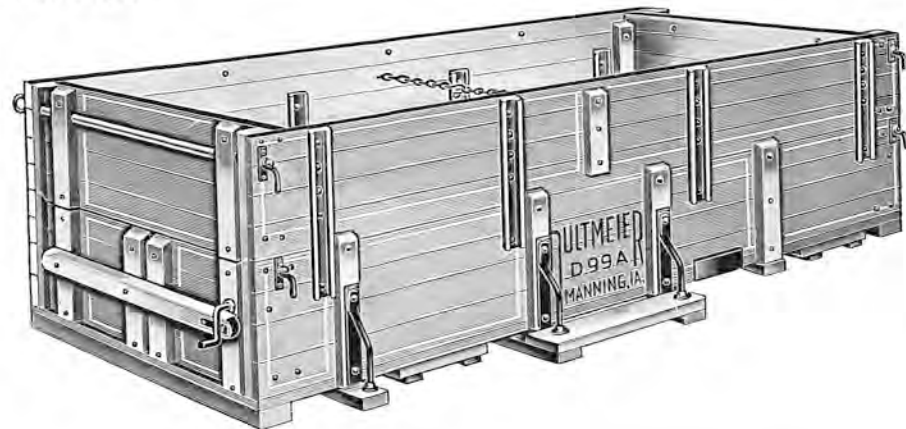

STANDARD LENGTH—10'6"
EXTRA STANDARD DEPTH—28"
 The D99A is of the same general construction as our six-cleat No. D80 and D802 quality boxes. Improved, however, by the use of 16 channel steel cleats to support the top half of each side. Each side of the D99A box is made up of the TOP and BOTTOM sections taken from the side of the D99 Iron Clad Tank Box. These sections are bolted together into one panel through the use of the 16 channel steel cleats. Finished in Wagon Box Green and striped in Panel Form. Irons are enameled Red.

No.	Approx. Wgt.	Price
D99A —With 1" Floor.....	350 lbs.	\$42.00
D99A-1¼—With 1¼" Floor.....	375 lbs.	44.35

DULTMEIER FLARED TIP TOP

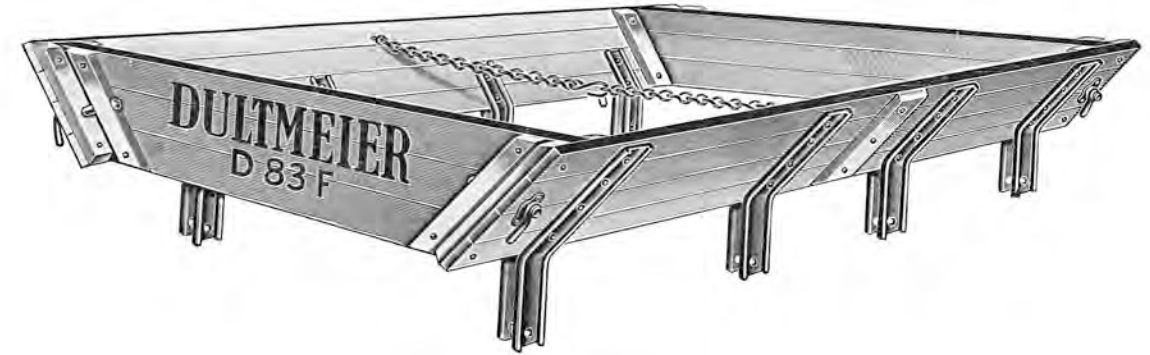

No. D83F

Made of Tongued and Grooved Fir Flooring.
 Equipped with Anti-Spread Chain.

Supported on regulation Wagon Box by four pair of formed Channel Iron Straddle Cleats that are shaped to the proper angle to make the same total width and angle of Flare as is used in the well known DULTMEIER Tank Box or No. D90.

Finished in Wagon Box Green only.

Irons are enameled Red.

Made to fit on any DULTMEIER WAGON BOX but can be used on any standard 10'6" wagon box by shifting the Straddle Cleats and Channel Irons to clear any box cleats that may be in the way.

Endgates and Sides support each other through Tail Nut and Bolt Style Gate Fasteners, eliminating use of rods.

Weight Price Each
 No. D83F—Flared Tip Top..... 100 lbs. \$15.15

DULTMEIER FLARE TOP

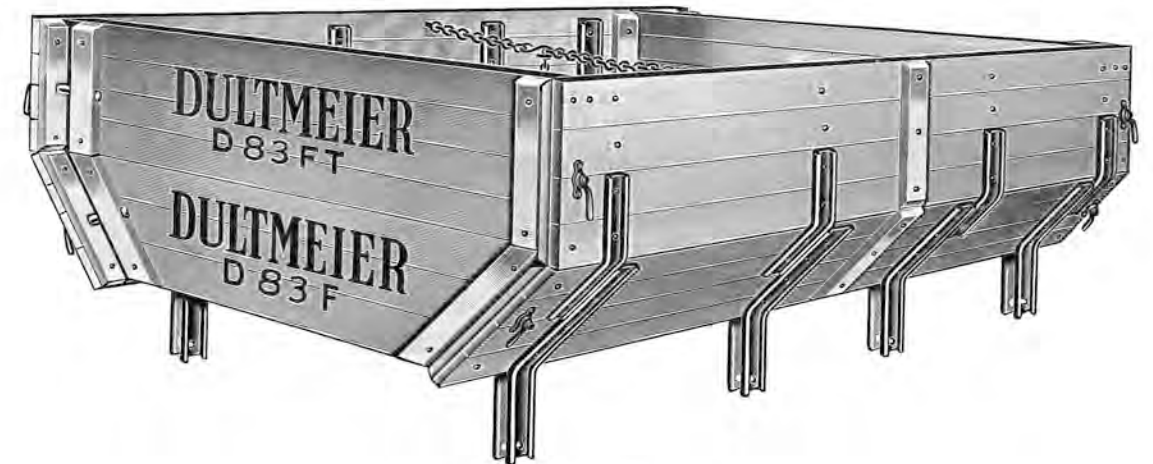

No. D83FT
 (Shown Mounted on No. D83F)

This unit is constructed the same as the No. D83F, except that it is furnished with full width square end Endgates.

The Channel Iron Straddle Cleats are applied opposite to their application on the D83F, bringing the D83FT Sides into vertical position.

The above illustration shows a No. D83FT Flare Top mounted on a No. D83F Flared Tip Top.

Finished in wagon box green only.

The use of a No. D83 Flared Tip Top with a D83FT Flare Top above it on a regular wagon box converts the regular wagon box into a TANK TYPE CORN PICKER BOX.

Weight Price Each
 No. D83FT—Flare Top..... 100 lbs. \$15.15

NOTE: This list price covers only the top half or D83FT portion of the above illustration.

DULTMEIER GRAIN-TITE TANK BOX

Catches all the Corn the Picker Picks

No. D90

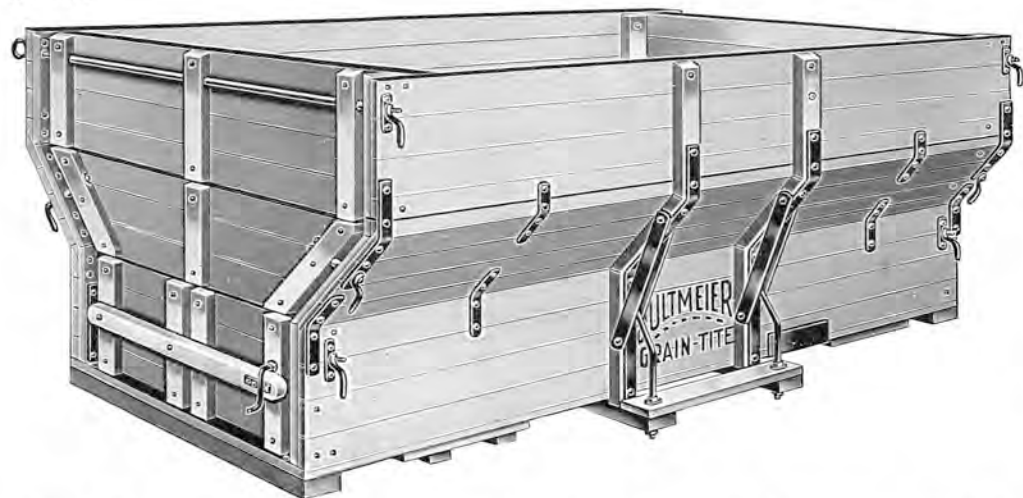

SPECIFICATIONS
 Length, 10'6" outside.
 Depth, 34 1/2" inside.
 Top Width, 52" inside.
 Bottom Width, 36" inside.
 Approximate Capacity:
 90 Bushels small grain;
 45 Bushels ear corn.

This box is excellent for use with mechanical corn pickers, combines, and field ensilage cutters. A Grain-Tite box built of fir flooring with tail nut rods, anti-spread chain, hinged endgate, strap bolts, rub irons, and side braces as used in all Dultmeier wagon boxes. The flared

side is triple supported by extra heavy clips at six points on each side, at the ends by endgate bolts with tail nuts and at the center cleats by extra heavy double braces. Supplied with 1" or 1 1/4" floor. Finished in wagon box green striped in panel form.

No.		Aprox. Wgt.	Price
D90	—With 1" Floor.....	400	\$50.25
D90-1 1/4"	—With 1 1/4" Floor.....	425	52.60
	Equipped with Dump Endgate additional .75		

Dultmeier Dump Engate

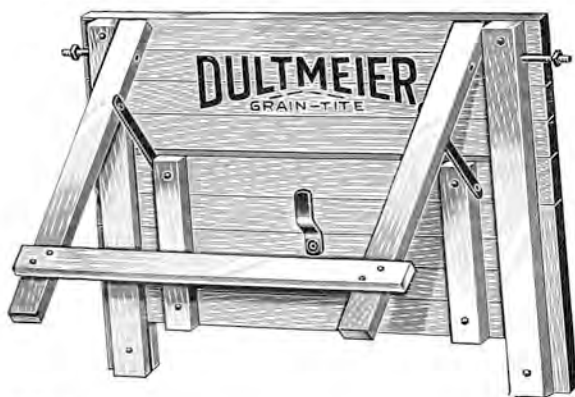

No. 1126A

Made of Fir Flooring and Hardwood cleats. Positive control while dumping load. Slide in gate can be completely raised for ease of dumping ear corn. Furnished either painted green or varnished. This is the Dump Endgate supplied on our one panel boxes when specified. Equipped with tail nuts instead of as illustrated.

Standard width for 38" wagon box.

No.	Approx. Wgt.	Price
1126A—Standard Box Style.....	25 lbs.	\$4.00
1126B—Tank Box Style for D90.....	35 lbs.	5.35
1126C—Tank Box Style for D99.....	35 lbs.	5.35

Flared Shoveling Board

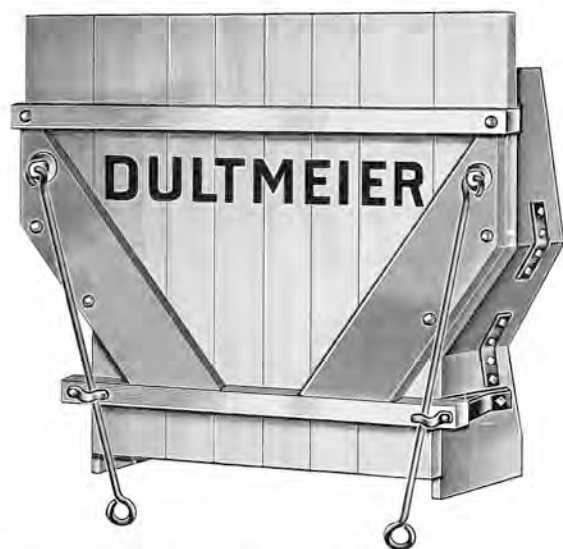

Style of construction very similar to our well known No. 142 Board. Sides braced and flared to fit our No. D90 Wagon Box. Three cross cleat style of construction. Painted Green. Irons Red and Black. Weight about 60 lbs.

No.	Height	Price
142F—1" Wings.....	42"	\$8.35

Dultmeier Shoveling Boards BRACED WING



Strong and durable. Simple and easy to handle. Locks securely in either position.

Made with Three Cross Cleats and of Tongued and Grooved Stock Double Nailed. Easy to Attach and Remove. Durable. A Good Seller. Shipping Weight, About 45 Pounds Each. Painted Green, Irons Red and Black. Packed two in a bundle.

No.	Height	Price
142—1" Wings.....	42"	\$5.35
148—1" Wings.....	48"	5.65

Boss Special



An economical Shoveling Board ideal for the occasional user. Weight, about 40 pounds each

Same material as in No. 142, but made with two cross cleats. Packed two in a bundle.

No.	Height	Price
42—1" Wings.....	42"	\$4.95

REPAIRS FOR SHOVELING BOARDS

No.	Price
5—Hooks.....	Each, \$0.06
3—R. & L. Side Irons.....	Pair, .30
4—Rods.....	Each, .23
18—Washers.....	Each, .08
19—Side Braces.....	Each, .21

Iron-Clad Shoveling Boards



A Board for a Lifetime

Built on a frame of heavy channel iron, standard size lumber, bolted not riveted. Shipping weight about 50 pounds each, painted red and black, irons red and black. Shipped set up. Each part easily replaced in event of wear or breakage. Heavy washers riveted through floor boards and center cleats.

No.	Height	Price
666—1" wings.....	42"	\$6.65
2666—1" wings.....	48"	7.00

Theiman Dump Endgate

26" High to Fit All Standard Boxes or Truck Widths

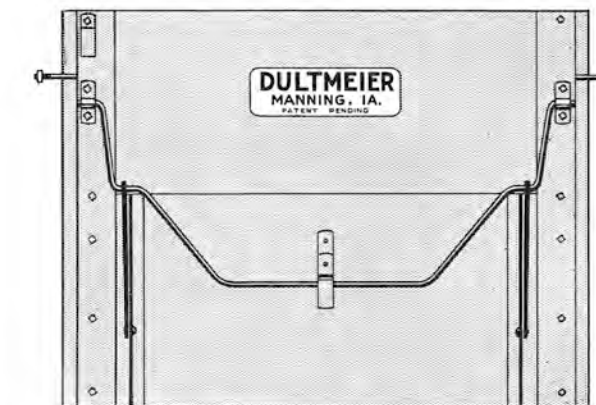

Positive control of load while dumping. Shipping weight, about 30 pounds each.

No.	Price
1126.....	\$5.25
Z30—60" or 68" Truck Width.....	10.25

No. 184 Dultmeier Adjustable Wagon Tongue

Self-Centering

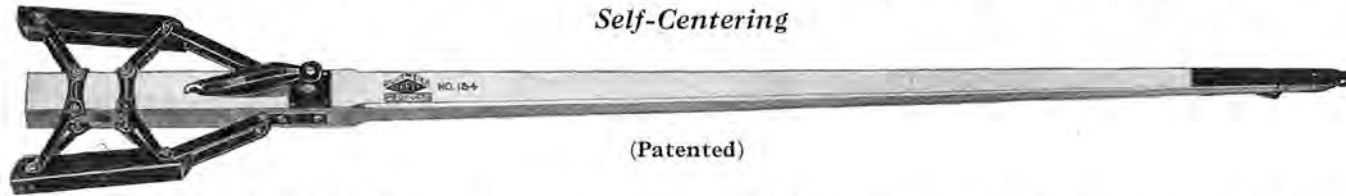

(Patented)

More than 50,000 in daily use
Furnished with either Oak, Malleable or Steel
Hounds at same price

Wood hounds are faced with steel painted black, the pole
painted red, varnished and striped.

Selected Oak Tongue, 3 1/2 x 3 1/2 at butt, 11'4" long.
Adjustment range is 10" to 16" at front, 15" to 21 1/2"
at rear.
When wider range is required we will furnish extra long
adjustment straps.

No.	Approx. Weight	Price
184 —With Wood Hounds	59 lbs.	\$9.10
184M—With Malleable Hounds	60 lbs.	9.10
184 S—With Steel Hounds	60 lbs.	9.10

No. 84 Special Adjustable Wagon Tongue

Self-Centering

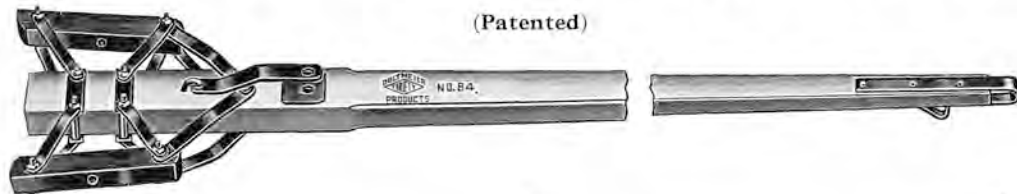

(Patented)

Made about the same as the famous No. 184, with minor
changes as shown by illustrations to lower the price.

No.	Weight	Price
84 —With Wood Hounds	59 lbs.	\$8.30
84S—With Steel Hounds	60 lbs.	8.30

No. 484 Dultmeier Adjustable Steel Wagon Tongue

Self-Centering



(Patented)

Furnished with either Oak, Malleable or Steel
Hounds at same price

rear from 15 inches to 21 1/2 inches. Lined hardwood side
members.
Painted red and varnished.

The open seam or slot which runs the entire length of
the tube makes it act as a spring when any strain is applied
to the tongue and minimizes bending or buckling.

No.	Weight	Price
484 —With Wood Hounds	65 lbs.	\$9.10
484M—With Malleable Hounds	65 lbs.	9.10
484 S—With Steel Hounds	65 lbs.	9.10
484H—Hounds for Steel Tongue	20 lbs.	3.90

12-gauge steel, 11 feet long; 4 inches diameter at base;
2 inches diameter at tip.

Hounds adjust at front from 10 inches to 16 inches, at

All Steel Combination Corn Picker Hitch and Wagon Tongue No. 684S



All steel construction of the same general principle as our
well-known No. 484 Steel Pole. Made for dual purpose use
by the combination slip joint and tractor hitch as illus-
trated. Note the extra Reinforcing Ring at the point where
internal pressure is the greatest.

No.	Weight	Price
684S—Complete, with Steel Hounds	70 lbs.	\$10.70

No. 184 Dultmeier Self-Centering Adjustable Hound



(PATENTED)

Hardwood side members lined with steel. Steel divider braces.
Tongue centers itself automatically while hound is being adjust-
ed. Hounds adjust at front from 10" to 16", at rear from 15"
to 22". Painted.

Weight, 18 pounds.

No.	Price
184 —With Wood Hounds	\$3.90
184M—With Malleable Hounds	3.90
184S —With Steel Hounds	3.90

No. 84 Self-Centering Hound



Hounds adjust at front from 10"
to 15 1/2", at rear 15" to 21".
This hound is used on our No.
84 Special Adjustable Tongue.
Weight, about 17 pounds.

No.	Price
84 —With Wood Hounds	\$3.35
84S—With Steel Hounds	3.35

Combination Tongue Joint



Used to quickly convert any wagon tongue into a tractor
hitch. Makes a solid joint when locked. Shipped one
complete in carton.

No.	Weight	Price
384-J—Joint	20 lbs.	\$4.55

No. 384 Combination Corn Picker Hitch and Tongue

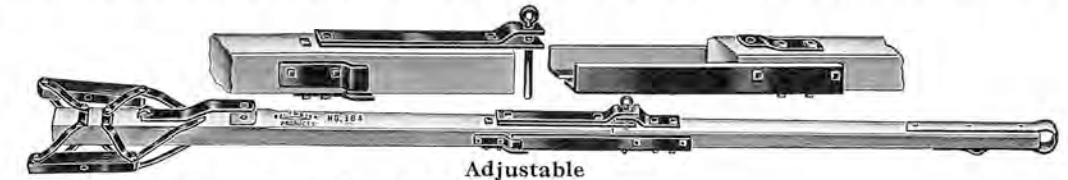

Adjustable

This combination Hitch is perfectly adapted to be used in
conjunction with Corn Pickers.

Hitch has tractor coupling while the tip has common pole
cap. For two wagons, the proper outfit is one combination
complete and one No. 384-H Hitch only. Hitches and Tips
are interchangeable.

No.	Weight	Price
384 —Combination, Complete	80 lbs.	\$13.15
384 S—Complete with Steel Hounds	80 lbs.	13.15
384-H—Hitch	50 lbs.	7.80
384T—Tip	30 lbs.	5.40

No. 284 Tractor and Truck Hitch



Adjustable

Length over all 6 feet. Furnished complete with Tractor
coupling hitch firmly bolted to end of tongue.

No.	Weight	Price
284—Complete	55 lbs.	\$7.60

Steel Repair Ends



For slipping over the end of a broken wagon tongue. A stiff,
tough and durable steel tube with an open seam in the
bottom to prevent crystallization. Has pole cap attached
and two bolt holes. Painted red.

No.	Length	Weight	Price
R384	3'	11 lbs.	\$1.60
R584	5'	14 lbs.	2.10

"TRU-TURN" 4-Wheel Trailer Hitch

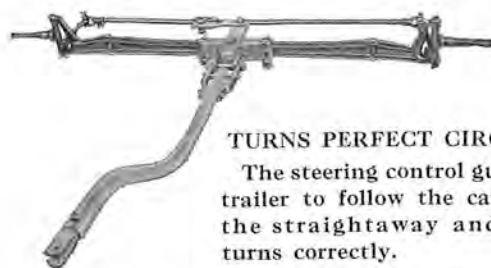

URNS PERFECT CIRCLE
The steering control guides trailer to follow the car on the straightaway and all turns correctly.

ONE SIZE FITS ALL TRAILERS

Fully adjustable to fit front axle and spindle tie rod of ANY chassis, cannot slip or bend.
No. Each
5-H—Trailer Hitch..... \$6.00

Trailer Bolster



Made from select Hardwood 2 3/4" x 2 3/4". Equipped with pressed steel stakes of special design 9 inches high. Made 38 inches between stakes. Can be fitted on any automobile chassis frame. Each bolster is furnished with 4 bolts and 2 clamps to attach to frame of chassis. Painted red. Weight 18 lbs.

No.	Each
9-B—Trailer Bolster.....	\$3.00
10-S—Trailer Bolster Stakes.....	.65

Oak Truck Bolsters



With Rings



Less Rings

No.	Each	No.	Price
1151—Front Bolster.....	\$4.15	1151-LR—Front Bolster.....	\$3.80
1152—Rear Bolster.....	3.65	1152-LR—Rear Bolster.....	3.40

Bolster Size 3 1/4 x 4 1/4. First Quality Oak. Ends reinforced with wide steel band. Front Bolsters have heavy bolster plate and are countersunk for 1 1/4" King Bolt. Top Plates prevent wear on bolster.

Stakes 10 1/4" high, well braced. Distance between stakes, 38". Painted Red. Weight, about 25 pounds each.

Wagon Bolsters with Rings and 15" Stakes available. See Price Guide.

Wagon End Gates



The hinged endgate is now made in the truck type.

No.	Size	Weight	Price
119—14" Hinged.....		10 lbs.	\$2.05
138—12" Plain.....		8 lbs.	1.05
139—13" Plain.....		8 lbs.	1.15
119-A—13" Hinged.....		8 lbs.	2.00
119-B—15" Hinged.....		9 lbs.	2.15
119-C—16" Hinged.....		10 lbs.	2.25

Finished in green and neatly striped. Made of Fir flooring same as Dultmeier wagon boxes.

Ironed and Painted Wagon Reaches



Front end rounded and riveted. King Bolt hole to permit 1 1/4" King Bolt. Extra heavy wearing irons used, one end being riveted through wood. This construction is much more desirable than plates merely nailed. Painted red.

No.	Size	Weight	Price
209—1 3/4 x 3 3/4—9'.....		20 lbs.	\$1.75
210—1 3/4 x 3 3/4—10'.....		23 lbs.	1.90
212—1 3/4 x 3 3/4—12'.....		27 lbs.	2.25
214—1 3/4 x 3 3/4—14'.....		35 lbs.	3.00

DULTMEIER FOLDING DRAW-BAR

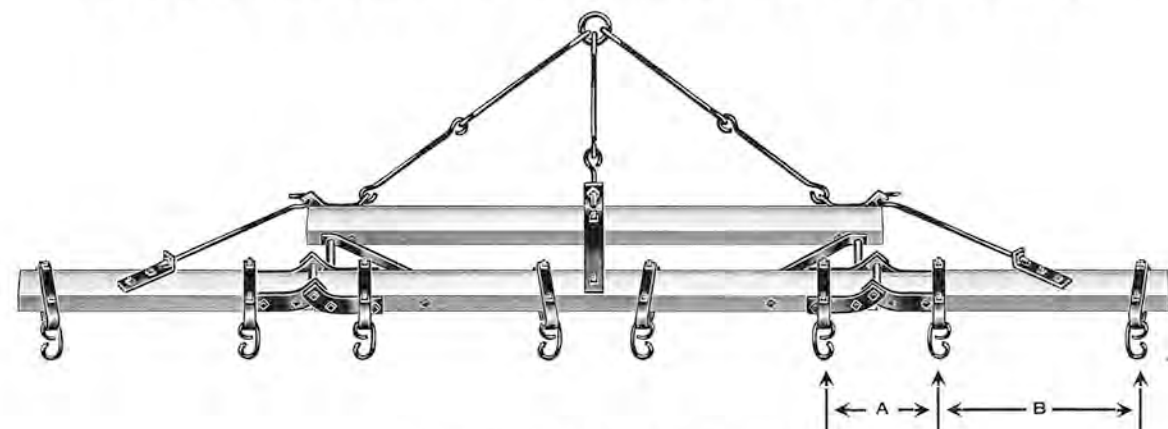

SPECIAL FEATURES

Ends and Center of Bar adjustable. Can't sag back.

Harrow sections pulled by Clevis and Rings that are adjustable to fit all makes of Harrows of a given total length. Each clevis is fitted with two machine bolts for secure anchoring.

Bar is not weakened by holes for Eye Bolts.

All metal parts are of wrought Iron or Steel, no castings.

Well Trussed and Braced construction permits light weight without sacrificing strength.

Furnished with Hooks for IHC Line of Harrows or with Links for all other makes. Be sure to specify which. Hooks are furnished unless otherwise specified.

The Dultmeier Folding Draw-Bar is furnished generally of Douglas Fir. Finished in Agricultural Red.

When ordering merely specify make, stock number, and width of Harrow or if this information is not available or certain, give measurements "A" and "B" and number of sections.

Length	No. of Sections	Fir Bar	Approx. Weight	List Price Each	Length	No. of Sections	Fir Bar	Approx. Weight	List Price Each
15'	3	DF15	65 lbs.	\$10.40	21'	4	DF21	95 lbs.	\$12.30
18'	3	DF18	80 lbs.	11.10	24'	4	DF24	100 lbs.	12.65
18'	4	DF18A	80 lbs.	11.75	25'	5	DF25	105 lbs.	14.95
20'	4	DF20	90 lbs.	12.00	30'	6	DF30	120 lbs.	20.00

(30 ft., 6 Sections made up on order)

DRAWBAR PARTS LIST

No. DI-10—Links.....	Each \$0.12
No. DI-11—Hooks.....	.12
No. DI- 9—Clevis with bolts.....	.24

A great time saver, works equally well with horse or tractor power. Simply hitch to the harrow in the farm lot, fold up the end sections, drive to work through gates or narrow lanes, fold down the end sections and the outfit is ready for work. No laborious loading and

unloading of the complete drag harrow. Above all, this bar permits the harrow to do better work on uneven ground because, being flexible, it follows the undulations.

AGRICULTURAL IMPLEMENT POLES

The Poles shown below are all standard sizes and will sell readily if carried in stock. Made from a specially selected grade of Durable Douglas Fir. All Poles straight grained, clear and free from stain. Douglas Fir does not warp or twist, withstands weather conditions better than any other wood. All stock guaranteed strictly first quality. It will test higher under strains and shock than the type of Yellow Pine now available for Implement Pole purposes. See U. S. Forest Products Laboratory tests to verify this statement.

SULKY RAKE, SWEEP RAKE, CULTIVATOR and PLOW POLES



No. 431 —1 5/8 x 3 1/4—11'. Due to the extra length it can be fitted to all Sulky Rakes and other machinery using a double pole. Weight, 10 lbs.	Each \$1.15	No. 437 —3 x 3 1/2—12'. An extra heavy Pole, used on many riding and two-row cultivators requiring a pole longer than our No. 432. Will fit John Deere and other Corn Planters, also nearly all makes of Listed Corn Cultivators. Weight, 27 lbs.	Each \$2.60
No. 432 —2 3/4 x 3 3/4—10'. Fits all Sweep Rakes. Proper size for fitting to nearly all Single and Double Row Cultivators. Weight, 20 lbs.	\$2.25	No. 437A —3 x 3 1/2—13'. Same as above except longer. The correct length used in Western Nebraska, Colorado & Wyoming. Weight, 32 lbs.	\$3.05
No. 433 —3 x 3—12'. The Standard size for all Sulky and Gang Plows. Can also be used on many Cultivators when an extra heavy pole is desired. Weight, 25 lbs.	\$2.35	No. 439 —2 3/4 x 2 3/4—10'. For Riding Cultivators. Weight, 18 lbs.	\$1.75
No. 433A —3 x 3—13'. Same as above but 13' long. For Two-Way Plows. Used in Western Irrigated Districts. Weight, 30 lbs.	\$2.55	No. 440 —2 3/4 x 2 3/4—12'. This size is very popular as a light cultivator and Sulky Plow Pole. Can be used in place of our No. 433. Weight, 20 lbs.	\$2.05

MOWER, BINDER, CORN BINDER, SPREADER and DRILL POLES



No. 434 —3 x 4—12'. Fits new models Grain Drills and Spreaders. Weight, 33 lbs.	Each \$2.95	No. 435A —3 x 5—14'. Same as above but longer. Also used on Corn Binders. Weight, 50 lbs.	Each \$3.90
No. 434A —3 x 4—13'. Fits nearly all spreaders and grain drills. Will interchange with M675 McCormick, A5840 Champion, Emerson and other machines using a heavy duty pole. Weight, 35 lbs.	\$3.05	No. 435B —3 x 5—15'. For use on Corn Binders. Weight, 55 lbs.	\$4.15
No. 435 —3 x 5—13'. Fits all new style mowers, and will interchange with M1251 McCormick, D1440, D2672 and all other Deering Mowers. Also used for Corn Pickers and many other machines. Weight, 40 lbs.	\$3.55	No. 436 —4 x 4—12'. Used extensively as a wagon and truck pole. Will fit Standard Mowers and many Disc Harrows. Weight, 35 lbs.	\$3.90
		No. 436A —4 x 4—14'. Used on many Binders, also Spreaders, Grain Drills, etc., where a heavier pole than our No. 434A is desired. Weight, 45 lbs.	\$4.40
		No. 441 —3 1/2 x 3 1/2—13'. Used in Corn Binders, Wagons and Disc Harrows. Weight, 40 lbs.	\$4.15

OAK IMPLEMENT POLES



No. 033 —3 x 3 x 12'. Proper size to be fitted to all Sulky Plows. Not bored. Made of thoroughly seasoned Ozark Oak. Weight, 25 lbs.	Each, \$3.00	No. 034 —3 x 4 x 13'. Oak Mower Pole. Same as No. 434, but made of best quality selected Ozark Oak. Weight, 40 lbs.	Each, \$4.65	No. 035 —3 x 5 x 13'. Oak Mower Pole. Same as No. 435, but made of selected Oak. Weight, 45 lbs.	Each, \$5.35
---------------------------------------------------------------------------------------------------------------------------------------------	--------------	----------------------------------------------------------------------------------------------------------------------------	--------------	---------------------------------------------------------------------------------------------------------	--------------

FITTED MACHINE POLES

Made of our regular Fir Pole Stock, bored, fitted and finished.

Our No.	Will Fit	Butt	Tip	Length	Machine	Wt.	Each
M40	MA1251	2 3/4 x 4 5/8	2 3/4 x 2 1/4	155 1/2"	MCCORMICK-DEERING Mower	40lb	\$4.20
M41	DB2672	2 3/4 x 5	2 3/4 x 2 1/4	156"	DEERING Mower	40lb	4.20
M42	M675	2 3/4 x 4	2 3/4 x 2 1/4	151"	MCCORMICK Mower	35lb	3.75
M43	Z6189 or Z2464 and DD2464	2 3/4 x 4 5/8	2 3/4 x 2 1/4	154"	JOHN DEERE Mower and Oil Bath Mower	40lb	4.20
M44	Z2638	2 3/4 x 4 1/8	2 3/4 x 2 1/4	156"	MCCORMICK-DEERING Oil Bath Mower	40lb	4.20
M46	VE660	2 3/4 x 4 1/2	2 3/4 x 2 1/4	186"	IHC Corn Binder	50lb	4.60
M47	Y2106	2 3/4 x 5 1/4	2 3/4 x 2 1/4	166"	IHC Corn Binder	50lb	4.60
M48	RA945	2 3/4 x 4 5/8	2 3/4 x 2 1/4	151"	IHC Side Delivery Rake	35lb	4.20
M49	13011SEM	2 3/4 x 3 3/8	2 3/4 x 2 1/4	143"	IHC Spreader	35lb	3.55
M50	M1516	2 3/4 x 4 1/4	2 3/4 x 2 1/4	152"	MINNESOTA Mower	40lb	4.20
M51	PAB247A	2 3/4 x 3 3/4	2 3/4 x 2 1/4	151"	MINNEAPOLIS-MOLINE Mower	40lb	4.20
M52	Z9007 and HH13673	2 3/4 x 4 5/8	2 3/4 x 2 1/4	155 3/4"	OLIVER No. 1 Mower	40lb	4.20
P1	YW102B	2 3/4 x 3 3/8	2 3/4 x 2 1/4	139 1/2"	JOHN DEERE 999 Corn Planter	25lb	3.20
P2	HZ9046	2 1/2 x 3 1/2	2 1/2 x 2 1/4	112"	JOHN DEERE Binder and all Tongue Trucks	25lb	2.65
P3	YW109B	2 3/4 x 3 1/2	2 3/4 x 3 1/2	111"	JOHN DEERE Two-Row Planter	22lb	2.65
P4	YW107	2 3/4 x 3 1/2	2 3/4 x 3 1/2	143"	JOHN DEERE High Wheel No. 999 Planter and 919 Drill	25lb	3.20
P5	RW 13247A for RW13450, 2553A and 2642A	2 3/4 x 3	2 3/4 x 3 1/2	128"	IHC No. 102 and 106 Planter	25lb	3.20
P6	13557A	2 3/4 x 3	2 3/4 x 3 1/2	117 3/4"	IHC No. 102 and 106 Planter with Tongue Truck	25lb	3.20

Sweep Rake and Stacker Teeth



YELLOW PINE — Extra Standard

Manufactured from Long Leaf Yellow Pine. All stock is clear and bright, entirely free from sap stain and other defects common in yellow pine.

Lumber is cut full size, and all teeth are finished to 1 3/4" thickness.

1 3/4" x 3 3/4" at butt, properly tapered for points.

No.	Weight	Each
8 YP— 8' long.....	10 lbs.	\$0.84
9 YP— 9' long.....	12 lbs.	.93
10 YP—10' long.....	15 lbs.	1.01

Standard

1 5/8" x 3 1/2" at butt, properly tapered for points.

No.	Weight	Each
8 YPS—8' long.....	9 lbs.	\$0.81
9 YPS—9' long.....	11 lbs.	.90

FIR — Standard

Manufactured from Old Growth dense Douglas Fir. 1 5/8" x 3 1/2" at the butt. OILED.

No.	Weight	Each
8F— 8' long.....	9 lbs.	\$0.73
9F— 9' long.....	11 lbs.	.84
10F—10' long.....	13 lbs.	.93

No. HARDWOOD TEETH

No.	Weight	Each
8 Oak—1 3/4 x 3 5/8— 8'.....	15 lbs.	\$0.98
9 Oak—1 3/4 x 3 5/8— 9'.....	17 lbs.	1.20
10 Oak—1 3/4 x 3 5/8—10'.....	20 lbs.	1.35

For Treating, add..... \$0.03
With metal paints, add..... .15

Deduct on orders for 50, 2c each; 200 or more, 3c each.

Sweep Rake Points

Will fit above-listed teeth.



No.	Weight	Each
100—Cast.....	1/2lb	\$0.12

Power Sweep Teeth

JOHN DEERE SIZES 2 1/2 x 2 3/4 BUTT	Weight	Each
No. 9 PJD.....	12 lbs.	\$1.08
No. 10 PJD.....	14 lbs.	1.20

UNIVERSAL SIZES 2 1/2 x 3 1/4 BUTT	Weight	Each
No. 9 PU.....	15 lbs.	\$1.08
No. 10 PU.....	18 lbs.	1.20

IHC SIZES 2 1/2 x 3 3/4 BUTT	Weight	Each
No. 9 PI.....	17 lbs.	1.08
No. 10 PI.....	20 lbs.	1.20

No. 100 will not fit power teeth.
No quantity discounts apply on power teeth.
All Tips measure 2 1/4" x 2 1/2".

Hickory Doubletree Woods

Made of Selected Mountain Growth Hickory



No.	Size	Weight	Per Doz.
40	1 5/8 x 3 1/2 x 34"—Machine.....	50 lbs.	\$5.60
42	1 3/4 x 3 3/4 x 42"—Plow.....	65 lbs.	6.75
48	2 x 4 x 48"—Wagon.....	100 lbs.	8.00
148	2 x 4 1/2 x 48"—Wagon.....	120 lbs.	9.45
248	2 1/2 x 4 1/2 x 48"—Wagon.....	140 lbs.	10.90

Hickory Neck Yoke Woods

(Made of High-Grade Mountain Grown Hickory)



No.	Size	Weight	Per Doz.
1N	2 5/8 x 40".....	48 lbs.	\$7.95
2N	2 3/4 x 44".....	60 lbs.	10.40
3N	3 x 48".....	65 lbs.	14.40

Hickory Singletree Woods



No.	Size	Weight	Per Doz.
1S	2 3/8 x 28" Machine (Oak).....	36 lbs.	\$2.80
2S	2 3/8 x 30" Plow.....	36 lbs.	2.70
3S	2 5/8 x 36" Wagon.....	48 lbs.	5.30

Cultivator Neckyoke Woods



No.	Size	Weight	Per Doz.
4N	2 5/8 x 42".....	48 lbs.	\$3.60

Plow and Cultivator Handles

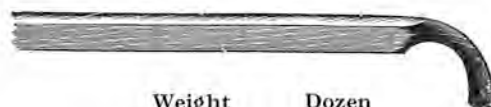

No.	Size	OAK	Weight	Dozen
4S	—1 1/4 x 2 1/4—5'—Straight		32 lbs.	\$3.70
4SC	—1 1/4 x 2 —4'—Straight Cultivator		28 lbs.	3.35

Yellow Pine Pump Rods

Shipped 100' to the bundle.



No.	Size	Weight	Per 100'
10	—1 1/8 x 1 1/8—16' Lengths	39 lbs.	\$4.00
13	—1 1/4 x 1 1/4—16' Lengths	45 lbs.	5.35
14	—1 1/2 x 1 1/2—16' Lengths	70 lbs.	5.65
For Treating, Add, Net .10			
No. 10—With Chamfered Corners, Per hundred extra, Net .35			

BENT OAK WAGON RIMS

No.	Size	Heights	Sets
7465	1 5/8 x 2"	3'0" 3'2" 3'4" 3'6" 3'8" 4'4" 4'6"	\$7.35
7465X	1 5/8 x 2 1/4"	3'0" 3'2" 3'4" 3'6" 3'8" 4'4" 4'6"	8.70
7466	1 3/4 x 2 1/4"	3'0" 3'2" 3'4" 3'6" 3'8" 4'4" 4'6"	8.70
7467	3 x 1 3/4"	3'0" 3'2" 3'4" 3'6" 3'8" 4'4" 4'6"	10.30
7467X	3 x 2"	3'0" 3'2" 3'4" 3'6" 3'8" 4'4" 4'6"	12.20

HOW TO ORDER—IMPORTANT

Eight rims make one complete set for four wheels.

When ordering, first give the tread, then the depth, then height of both front and hind wheels.

Indicate height of wheels as follows:

3⁸ meaning 3 foot 8 inches—not 38 inches.

4⁶ meaning 4 foot 6 inches—not 46 inches.

We do not break bundles.

HELP AVOID MISTAKES

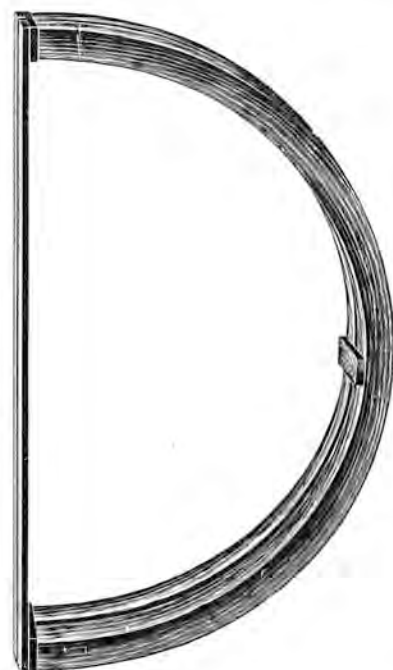

OAK WAGON SPOKES



Size	Per Set	Size	Per Set
2 1/8"	\$7.90	2 1/8"	\$ 9.95
2 1/4"	8.50	2 1/4"	10.60
2 3/8"	9.10	2 3/8"	11.35

NOTE:—52 spokes to the set. Fronts, 24 to the bundle. Hinds, 28 to the bundle.

Front bundles only 1/2 price of full set. Hind bundles only 3/5 price of full set. We do not sell less than full bundles.

Oak Wagon Poles



Square Butt, 11'6" Long, Universal Finished, Clear, Perfect Sticks of Air Dried Ozark Oak, Thoroughly Seasoned

No.	Weight	Each	No.	Weight	Each
185—3 1/4"	35 lbs.	\$4.00	189—No. 2—3 1/2"	40 lbs.	\$3.00
186—3 1/2"	40 lbs.	4.00	190—3 1/2" Painted Red	40 lbs.	3.35
187—3 3/4"	45 lbs.	4.70	191—No. 1—Rough Wagon Poles, 12'	75 lbs.	3.70
188—4"	48 lbs.	5.35			

Hickory Axles



FINISHED

No.	Weight	Each
24 —3 1/4—Taper Sawed	25 lbs.	\$3.55
24T —3 1/4—Turned End	25 lbs.	4.20
24 1/2 —3 1/2—Taper Sawed	30 lbs.	4.00
24 1/2 T—3 1/2—Turned End	30 lbs.	4.70
25 —4 —Taper Sawed	35 lbs.	5.35

ROUGH

No.	Weight	Each
74—3 1/2 x 4 1/2—6'	35 lbs.	\$2.80
75—4 x 5 —6'	40 lbs.	3.50

For surfacing Rough Axles, add, Each, Net .20

Oak Bolsters



FRONT—Finished

No.	Weight	Each
44 —3 1/4 NT	15 lbs.	\$1.95
44 1/2 —3 1/2 NT	16 lbs.	2.30

Mortising, 15 cents; boring, 8 cents Net, Each.



REAR—Finished

No.	Weight	Each
54 —3 1/4 NT	15 lbs.	\$1.95
54 1/2 —3 1/2 NT	16 lbs.	2.30

Mortising, 15 cents Each, Net.

Rough

No.	Weight	Each
55—3 x 4 —4'	16 lbs.	\$1.20
56—3 1/2 x 4 1/2—4'	18 lbs.	1.35
57—4 x 5 —4'	22 lbs.	2.00

Oak Harrow Bars

No.	Weight	Each
HB-1— 3/8" x 2 1/4" x 60"	5 lbs.	\$0.20
HB-2—1 3/4" x 2 1/4" x 60"	7 lbs.	.40
HB-3—2 1/4" x 2 1/4" x 60"	9 lbs.	.50

Oak Wagon Reaches in White

Clear, Straight Grain Stock
Rounded One End, With King Bolt Hole

No.	Weight	Each
109—1 3/4 x 3 3/4— 9'	24 lbs.	\$1.40
110—1 3/4 x 3 3/4—10'	27 lbs.	1.60
112—1 3/4 x 3 3/4—12'	32 lbs.	1.95
114—1 3/4 x 3 3/4—14'	37 lbs.	2.25

Oak Tongue Hounds



Extra Heavy Pattern

No.	Weight	Pair
83 —1 3/4" Oak NT S2S	5 lbs.	\$1.20

Oak Front or Rear Hounds



No.	Weight	Pair
86 —1 3/4" Rear, S2S	8 lbs.	\$1.70
88 —1 3/4" Straight Front, S2S	8 lbs.	1.70

Oak Sandboards



No.	Weight	Each
80—3 1/4"	10 lbs.	\$1.75
81—3 1/2"	11 lbs.	2.00

Cultivator Beams

No.	Weight	Each
92 —2 1/4 x 2 1/2—4'—To fit all cultivators	7 lbs.	\$0.60
92A—To fit Overland	7 lbs.	.80

HAY LOADER SLATS AND BARS

We are in a position to furnish you with all types of Hay Loader Web Slats, Hay Loader Web Bars and Side Delivery Rake Bars. It is only necessary for you to give us the width, thickness, length and distance between holes on any Hay Loader Bar or Slat and we will be able to furnish it. Or order by manufacturer's number and you will get what you require. Made of clear straight yellow pine.

CARRIER SLATS—FITTED			
Our No.	Will Fit	Size	Price
H1	AW 207 John Deere	1 x 1 3/8—90 1/4"	\$0.34
H2	AW 254 J. Deere AW350	1 x 1 3/8—70 1/8"	.27
H3	AW 275 J. Deere AW 349	1 x 1 3/8—61 3/4"	.27
H4	BA492 Massey-Harris	1 x 1 1/4—60"	.24
H5	D504 Minnesota	1 x 1 1/4—62 3/4"	.24
H6	K or KZ885 I. H. C.	1 x 1 1/4—64 1/8"	.24
H7	K1583 I. H. C.	1 x 1 1/4—61 3/4"	.24
H8	KZ1111 I. H. C.	1 x 1 1/8—64 1/8"	.21

CARRIER SLATS—BLANK			
Our No.	Use For	Size	Price
H15	I. H. C. No. KZ1111	1 x 1 1/8—6'	\$0.18
H16	I. H. C. No. K1583, Z885, Rock Island W1016, Massey-Harris B492, BA49, BA492, T5130 Minnesota No. D504	1 x 1 1/4—6'	.20
H17	I. H. C. No. K1373	1 x 1 1/8—8'	.24
H18	Massey-Harris No. B302	1 x 1 1/4—8'	.27
H19	John Deere all No's	1 x 1 3/8—8'	.30
H20	John Deere all No's	1 x 1 3/8—6'	.23

RAKER BARS—FITTED			
Our No.	Will Fit	Size	Price
H22	HL124A Moline	1 1/4 x 2—11'8"	\$1.08
H23	L5052 Dain	1 1/8 x 2—12'	.95
H24	L5185 Dain	1 1/8 x 2—12'4"	1.13
H25	No. 52 and Later, New Idea	1 1/8 x 2 1/4—10'9 1/2"	1.20

RAKER BARS—BLANK			
Our No.	Use For	Size	Price
H35	I.H.C No. K11075, K11070	1 x 2 —12'	\$0.80
H36	I.H.C. No. 1124G, 1125G	1 x 2 —14'	.90
H37	Dain No. L5052	1 1/8 x 2 —12'	.81
H38	Dain No. L5185	1 1/8 x 2 —14'	.99
H39	Universal Blank	1 1/8 x 2 1/4—14'	1.00
H40	Moline No. HL124A	1 1/4 x 2 —12'	.95
H41	Universal Blank	1 1/4 x 2 —14'	1.15
H42	Emerson	1 3/8 x 2 1/4—14'	1.40
H43	Universal Blank	1 1/2 x 2 —14'	1.25

MISCELLANEOUS PARTS			
Our No.	Part	Size	Price
H46	Side Delivery Rake	1 1/2 x 2 —10'	\$0.87
H47	Side Delivery Rake	1 1/2 x 2 —12'	1.05
H48	Compression Slats	1 x 1 1/4—14'	.68
H49	Oak Reinforcing Strips	1/2 x 2 —28"	.14

MANURE SPREADER SLATS



Made of clear Yellow Pine thoroughly creosoted. Bored to fit. Will fit below named machines and are interchangeable with those furnished by the original manufacturer.

No.	Machine	Dimensions	Finish	Each
1M	John Deere	1 1/8 x 3 1/2 x 49 1/2"	Creosoted and Bored	\$0.24
4M	Great Western	1 1/8 x 3 1/2 x 40 1/4"	Creosoted and Bored	.24
6M	Great Western	1 1/8 x 3 1/2 x 51 3/4"	Creosoted and Bored	.24
8M	I. H. C.	1 1/8 x 4 x 44"	Creosoted and Bored	.30
9M	I. H. C.	1 1/8 x 4 x 53"	Creosoted and Bored	.30
12M	Litchfield	1 1/8 x 4 3/4 x 39"	Creosoted and Bored	.31
13M	Litchfield	1 1/8 x 4 3/4 x 51"	Creosoted and Bored	.35
16M	Moline	1 1/8 x 3 1/2 x 41"	Creosoted and Bored	.24
17M	Moline	1 1/8 x 3 1/2 x 48 3/4"	Creosoted and Bored	.24
19M	Robinson	1 1/8 x 2 3/4 x 32 1/4"	Creosoted and Bored	.20
31M	Repair	1 1/8 x 3 1/2 x 54"	Creosoted. Blank	.23

Pump Jack Pitman Woods

Made of hardwood lumber, 1" hole drilled at one end and cross riveted to prevent splitting.

No.	Each
P001—1 1/8" x 1 3/4"—5'	\$0.53

Other sizes furnished on order.

Hay Sling Bars

Hardwood blanks surfaced to correct size and shape.

No.	Length	Weight	Price Ea.
HS4	4'	5 lbs.	\$0.24
HS5	5'	7 lbs.	.30
HS6	6'	10 lbs.	.36

Binder Reel Fans



Our No.	Blank Length	For	PAINTED WHITE		Blank Each	Fitted Each
			Weight	Price		
RF6	64"	6' Binders	1 1/2 lbs.	\$0.25	\$0.27	
RF7	76"	7' Binders	1 3/4 lbs.	.30	.32	
RF8	88"	8' Binders	2 lbs.	.35	.35	
RF10	120"	10' Binders	2 1/2 lbs.	.43	.48	
RF12	144"	12' Binders	3 lbs.	.54	.60	

All fitted fans will interchange with those furnished by manufacturers. All makes furnished at above prices. Order by factory numbers.

Binder Reel Arms



All fitted arms are interchangeable with those furnished by the manufacturers. Made of clear oak or ash, numbered and varnished.

BLANKS (One Hole Bored)

No.	Length	Weight	Each
RA35	35"	1 lb.	\$0.19
RA40	40"	1 lb.	.19

FITTED

To Fit	Each
Deering No. E1392	\$0.27
McCormick No. H904	.23
All Others	.19

Blank Canvas Slats



Made of tough textured ash. 100 to bundle. Stock one size for all binders.

No.	Size	Weight	Per C
CS56	7/16 x 7/8 x 56	50 lbs.	\$6.00

FOR HEADERS AND COMBINES

No.	Size	Weight	Per C
CS42	1/2 x 7/8 x 42	45 lbs.	\$6.00

Grass Boards



Machined from clear hardwood. Blank or fitted, but not ironed. All fitted boards are numbered and finished. Blank boards have one large hole.

No.	Weight	Each
GB1—BLANK	4 lbs.	\$0.59
FITTED—To Fit All Makes		.69

Order Fitted Boards by original number.

Binder Pitmans



Will interchange with manufacturers parts. Machined of hardwood, riveted, numbered and varnished. Weight, about 2 pounds.

To Fit	Each
Deere B8745 Tractor	\$0.80
Johnston K118C	.67
Massey-Harris S1032	.67
McCormick B763	.65
McCormick V876	.65
Obsolete machines, Acme, Adriance, Buckeye, Independent, Plano, Wood	1.95
All Others	.48

Grass Board Sticks



To fit all machines. Slanted but not bored.

No.	Weight	Each
1GBS	2 lbs.	\$0.36

Mower Pitman Woods



Made of straight grained Hickory, varnished. Fitted woods will interchange with original parts and are riveted, but not ironed.

No.	Weight	Each
BPI—BLANK	2 lbs.	\$0.43
FITTED—Bored to fit all makes		.47

See quick reference charts in section No. 2 for correct numbers, if in doubt of any item on this page.

Tractor Draw Bar Clevis



No. 7125DB

The latest type clevis for use on Tractor Drawbars. 3/4" material, 2 3/4" opening, 4" spacing between center of bolt holes. Weight 45 lbs. per dozen.

Net each..... \$0.89

Twist Clevis



Cat. No....	No. 2R	No. 4R	No. 7125T
Kind.....	End	End	Tractor
Size.....	3/4 x 2 1/2	7/8 x 2 5/8	1 1/4 x 4 1/2
Lbs. per doz.	11 1/2	16	35
Pin.....	Loose	Screw	Loose
Each.....	\$0.29	\$0.35	\$0.57

Tractor Clevis



Approximate weight, 35 lbs. per Dozen.

Cat. No.	Size	Pin	Each
7125	1 1/2 x 5	Screw	\$0.42
A4	1 1/4 x 4 3/4	Loose	.54

Round Back Clevis



SCREW PIN

Cat. No...	2RB	5RB	7RB	8RB
Size.....	2x4	2 1/2x5	2 3/4x6	3x8
Lbs. doz..	16 1/4	16 1/2	19	32 1/2
Each.....	\$0.27	\$0.31	\$0.33	\$0.48

Round Clevis



SCREW PIN

Cat. No...	5244	5225	3226	3228
Size.....	2 1/4x4	2 1/4x5	2 1/2x6	3x8
Lbs. doz..	17	19	29 1/2	34 1/2
Each.....	\$0.31	\$0.33	\$0.35	\$0.53

Flat Steel Clevis

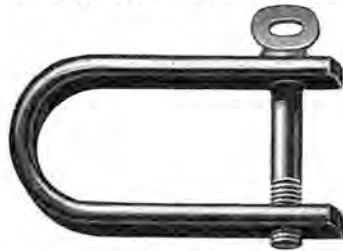

SCREW PIN

Cat. No.	Size	Lbs. per Doz.	Each
2334	2 x 4	15	\$0.23
LOCK PIN			
151	2 x 3 3/4	22	.29

Straight End Clevis



Approximate weight, 12 lbs. per Dozen.

Cat. No.	Size	Pin	Each
1R	1 1/2 x 2 1/4	Loose	\$0.27
1422	1 1/4 x 2 1/4	Screw	.31

Malleable Swivel Clevis



Approximate weight, 13 lbs. per Dozen
3/4" x 4 3/8"

No.	Each
2824	\$0.30

EYE BOLTS



DOUBLE PATTERN HARROW

D742	1/8" Stock	Bolt	Lbs. Doz.	Each
D762	3/16" Stock	4 1/2"	8	\$0.16
		6 1/2"	10	.15

CULTIVATOR NECKYOKE

D732	1/8" Stock	3" & 3 1/2"	Bolts	Lbs. Doz.	Each
			8	8	\$0.15



SINGLE LINK PATTERN

L742	1/8" Stock	Bolt	Lbs. Doz.	Each
L762	3/16" Stock	4 1/2"	8	\$0.16
		6 1/2"	10	.18

Harrow Hooks



No. 98
For Flat Bar Harrows
Hole 1/4", Length 3 3/4"



No. 99
For U Bar Harrow
Hole 1/4", Length 5 1/4"



No. H-24
Clevis Type
Beam width 5/8", Length 4"
Cat. No. Lbs. Doz. Each
98..... 5 1/2 \$0.15
99..... 9 .20
H24..... 5 .15

Disc Bumpers



Weight 5 lbs. Diameter 7".
Specify whether 3/4" or 1" Hole.

No. 45	Each
	\$0.68

Extension Spools



Pairs complete with Bolts and Keys.
Weight 19 lbs for 3/4" and 1" Shaft.

No. 751	Pair
	\$2.33

Spreader Spools



Universal

No. 71	Weight	Each
	3 1/2 lbs.	\$0.75

Steel Harrow Teeth



Shouldered, Threaded and Nuted
(with 5/16" x 2" Shank)

No. 5	1/2" x 8"	Per lb.
		\$0.18
Plain		
No. 6	1/2" x 8"	Per lb.
		\$0.12
No. 7	1/2" x 9"	Per lb.
		.14
Headed		
No. 8	1/2" x 8"	Per lb.
		.14

Hay Rack Fixtures

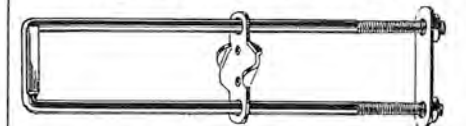

For use with 2" Sills. Complete set in box—8 clamps, 3/8" round steel, inside width 2 3/4", with 8 center plates, upper and lower washers and 16 nuts. Cut threads.

No.	1	2	3
Size...	14"	16"	18"
Lbs....	12	13	14
Sets...	\$1.55	\$1.65	\$1.85

Truck Clamps

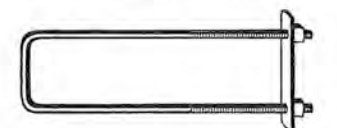

For fastening Truck bodies to chassis or making Hay Racks with heavy sills made of 1/2" round steel with 6" threads, one washer plate and 2 nuts furnished.

No.	Width	Length	Weight	Price Each
B4	4"	12 1/2"	2 1/2 lbs.	\$0.36
B5	4"	15"	2 1/2 lbs.	.39
B6	4"	20"	2 3/4 lbs.	.48

Hay Rack Loops and Pockets



No. 6S



No. 4S

No.	Pocket Opening	Overall Size	Lbs. Doz.	Each
4S...	1 1/2" x 3"	1 1/2" x 2 1/2"	12 ga. x 3	—6"
6S...	1 3/4" x 4"	1 3/4" x 4"	12 ga. x 1 3/4	—9"
			19	\$0.12
			15	.15

Postage
Will Be Paid
by
Addressee

No
Postage Stamp
Necessary
If Mailed in the
United States

BUSINESS REPLY CARD

First Class Permit No. 1 Sec. 384½ P. L. & R. Manning, Iowa

DULTMEIER MANUFACTURING CO.

P. O. BOX 427

MANNING, IOWA



Postage
Will Be Paid
by
Addressee

No
Postage Stamp
Necessary
If Mailed in the
United States

BUSINESS REPLY CARD

First Class Permit No. 1 Sec. 384½ P. L. & R. Manning, Iowa

DULTMEIER MANUFACTURING CO.

P. O. BOX 427

MANNING, IOWA



Postage
Will Be Paid
by
Addressee

No
Postage Stamp
Necessary
If Mailed in the
United States

BUSINESS REPLY CARD

First Class Permit No. 1 Sec. 384½ P. L. & R. Manning, Iowa

DULTMEIER MANUFACTURING CO.

P. O. BOX 427

MANNING, IOWA



Postage
Will Be Paid
by
Addressee

No
Postage Stamp
Necessary
If Mailed in the
United States

BUSINESS REPLY CARD

First Class Permit No. 1 Sec. 384½ P. L. & R. Manning, Iowa

DULTMEIER MANUFACTURING CO.

P. O. BOX 427

MANNING, IOWA



**Dultmeier Goods
are
Good Goods**

Tank Type Wagon Boxes
Wagon Boxes
Hog Feeders
Hay Racks
Shoveling Boards
Implement Poles
Adjustable Tongues
Tractor and Trailer Hitches
—and—
Hardwood Lumber
and Implement Woodstock
of all kinds

**Dultmeier
Jobbing Lines Include**

*Everything of the Best
and
The Best of Everything*

Stover Air Cooled Engines
Stover Horizontal Gasoline Engines
Stover Horizontal Kerosene Engines
Stover Vertical Engines (Power Unit)
Stover Direct Connected Pumping Units
Stover Diesel Engines
Samson Oil-Rite Roller Bearing Windmills
Samson Oil-Rite Plain Bearing Windmills
Stover Steel Towers for Radio, Windmills, Tanks, etc.
Stover Burr Grinders
Stover Stationary Saw Frames
Stover Limestone Pulverizer
Myers Hand and Windmill Pumps
Myers Water Supply Systems
Myers Cylinders
Myers Spray Rigs and Equipment
Peru Trucks and Gears
American Cream Separators
Atlas Redwood Tanks
Storm Lake Tanks
Columbian Steel Tanks
Columbian Hog Troughs
Columbian Tank Heaters
Columbian Grain Bins
Columbian Hog Feeders
Thieman Saw Frames
Thieman Hog Feeders
Thieman Stock Waterers
Rowe Ladders
Lattice and Lawn Trellis
White Picket Fence
Heider Ironed Woodstock
Heider Ladders