

FYH. Ball Bearing Units

High Quality Ball Bearing Units from FYH. Japanese Made design keeps contaminants such as water or dust from entering the bearing. Grease nipple is included with all units. Bearings are pre-lubricated and do not require additional grease upon installation. Cast iron housings, hardened steel balls and self-aligning feature ensures long, trouble-free performance. Available in 2-bolt, 3-bolt, 4-bolt and pillow block styles. Many common sizes are shown but other styles and sizes are available on request. *(Stainless, Nickel-Plated or Thermoplastic housings are also available).*

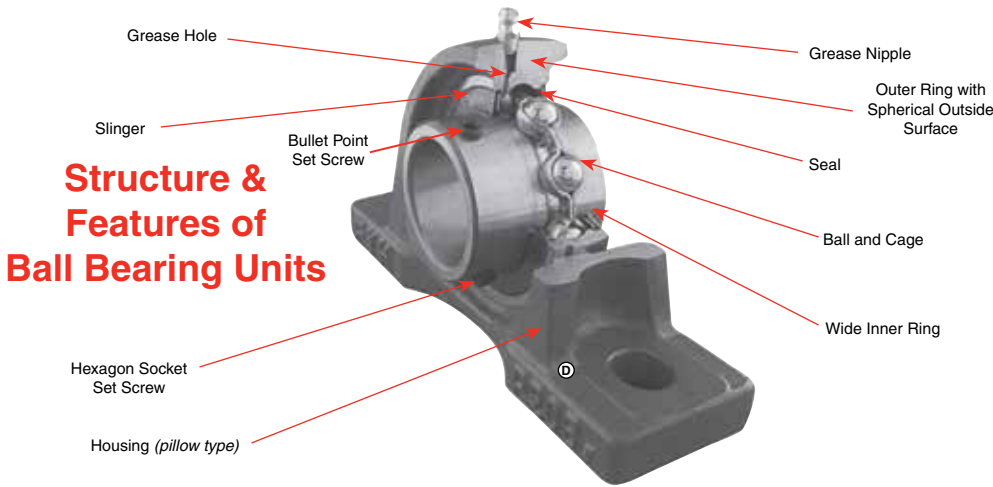

Structure & Features of Ball Bearing Units

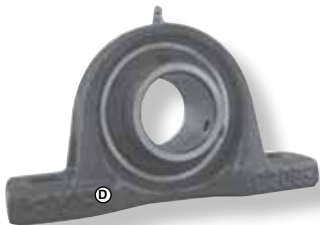
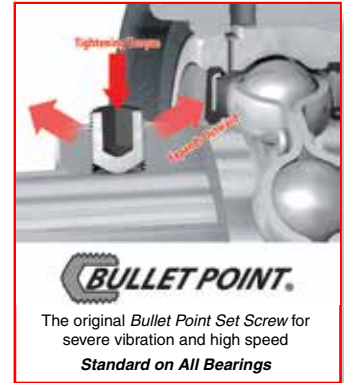

UCP
Pillow Block Bearing,
2-Bolt Base

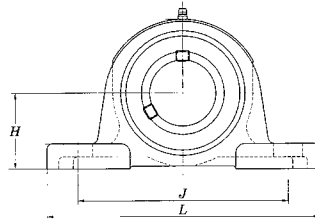

Pillow Block Bearings, 2-Bolt Base

Part No.	Bore	H	J	L
FY UCP20412	3/4"	1-5/16"	3-3/4"	5"
FY UCP20514	7/8"	1-7/16"	4-1/8"	5-1/2"
FY UCP20516	1"	1-7/16"	4-1/8"	5-1/2"
FY UCP20619	1-3/16"	1-11/16"	4-3/4"	6-1/2"
FY UCP20720	1-1/4"	1-7/8"	5"	6-9/16"
FY UCP20824	1-1/2"	1-15/16"	5-13/32"	7-1/4"
FY UCP20928	1-3/4"	2-1/8"	5-3/4"	7-15/32"
FY UCP21031	1-15/16"	2-1/4"	6-1/4"	8-1/8"
FY UCPX1032	2"	2-1/2"	6-23/32"	9-1/2"
FY UCP21236	2-1/4"	2-3/4"	7-1/4"	9-1/2"
FY UCP21239	2-7/16"	2-3/4"	7-1/4"	9-1/2"



UCPAN
Pillow Block Bearing,
Tapped Base

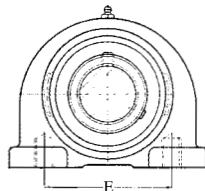

Pillow Block Bearings, Tapped Base

Part No.	Bore	E
FY UCPAN20516	1"	2"
FY UCPAN20720	1-1/4"	3-1/4"
FY UCPAN21031	1-15/16"	4"



UCF
4-Bolt Flange
Bearing

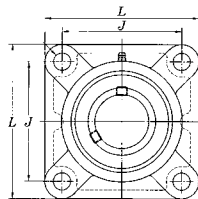

4-Bolt Flange Bearings

Part No.	Bore	J	L
FY UCF20412	3/4"	2-33/64"	3-3/8"
FY UCF20516	1"	2-3/4"	3-3/4"
FY UCF20619	1-3/16"	3-17/64"	4-1/4"
FY UCF20720	1-1/4"	3-5/8"	4-19/32"
FY UCF20824	1-1/2"	4-1/64"	5-1/8"
FY UCF21031	1-15/16"	4-3/8"	5-5/8"
FY UCF21132	2"	5-1/8"	6-3/8"



UCFL
2-Bolt Flange
Bearing

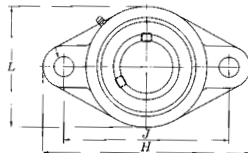

2-Bolt Flange Bearings

Part No.	Bore	H	J	L
FY UCFL2048	1/2"	4-7/16"	3-35/64"	2-3/8"
FY UCFL20516	1"	5-1/8"	3-57/64"	2-11/16"
FY UCFL20620	1-1/4"	5-13/16"	4-39/64"	3-5/32"
FY UCFL20723	1-7/16"	6-11/32"	5-1/8"	3-17/32"
FY UCFL20824	1-1/2"	6-7/8"	5-43/64"	3-15/16"
FY UCFL21031	1-15/16"	7-3/4"	6-3/16"	4-17/32"
FY UCFL21032	2"	8-13/16"	7-1/4"	5-1/8"



UCFB
3-Bolt Flange
Bearing

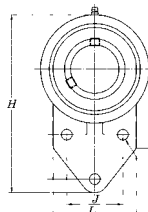

3-Bolt Flange Bearings

Part No.	Bore	H	J	L
FY UCFB20210	5/8"	4-11/32"	1-17/64"	2-7/16"
FY UCFB20516	1"	4-9/16"	1-11/32"	2-11/16"
FY UCFB20720	1-1/4"	5-21/32"	1-13/16"	3-17/32"